

THE GREAT BRITISH *Sewing Bee*

Hacking Jacket pattern

Project design © Simplicity Ltd 2013

This design is protected by copyright
and must not be made for resale.

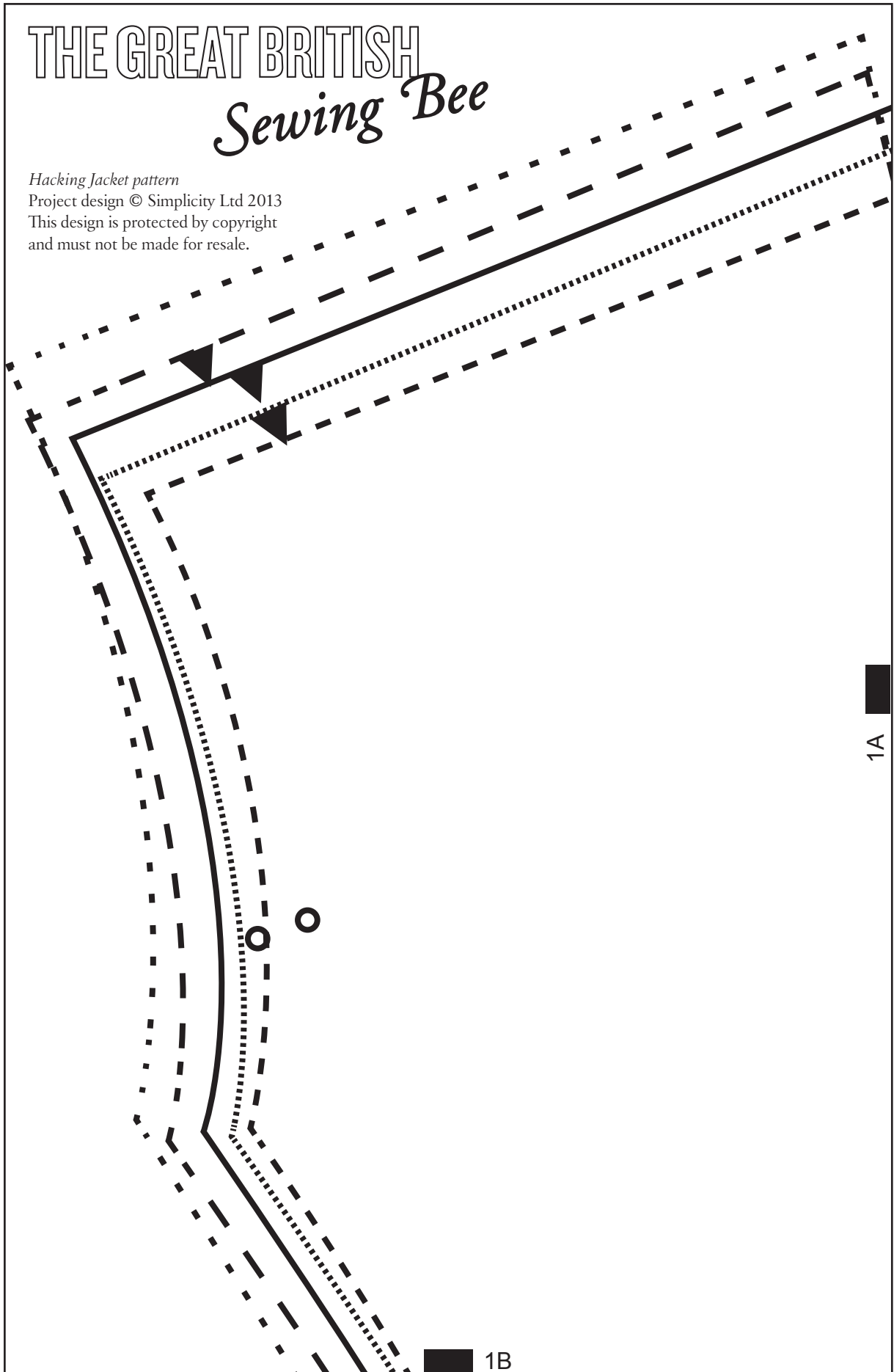

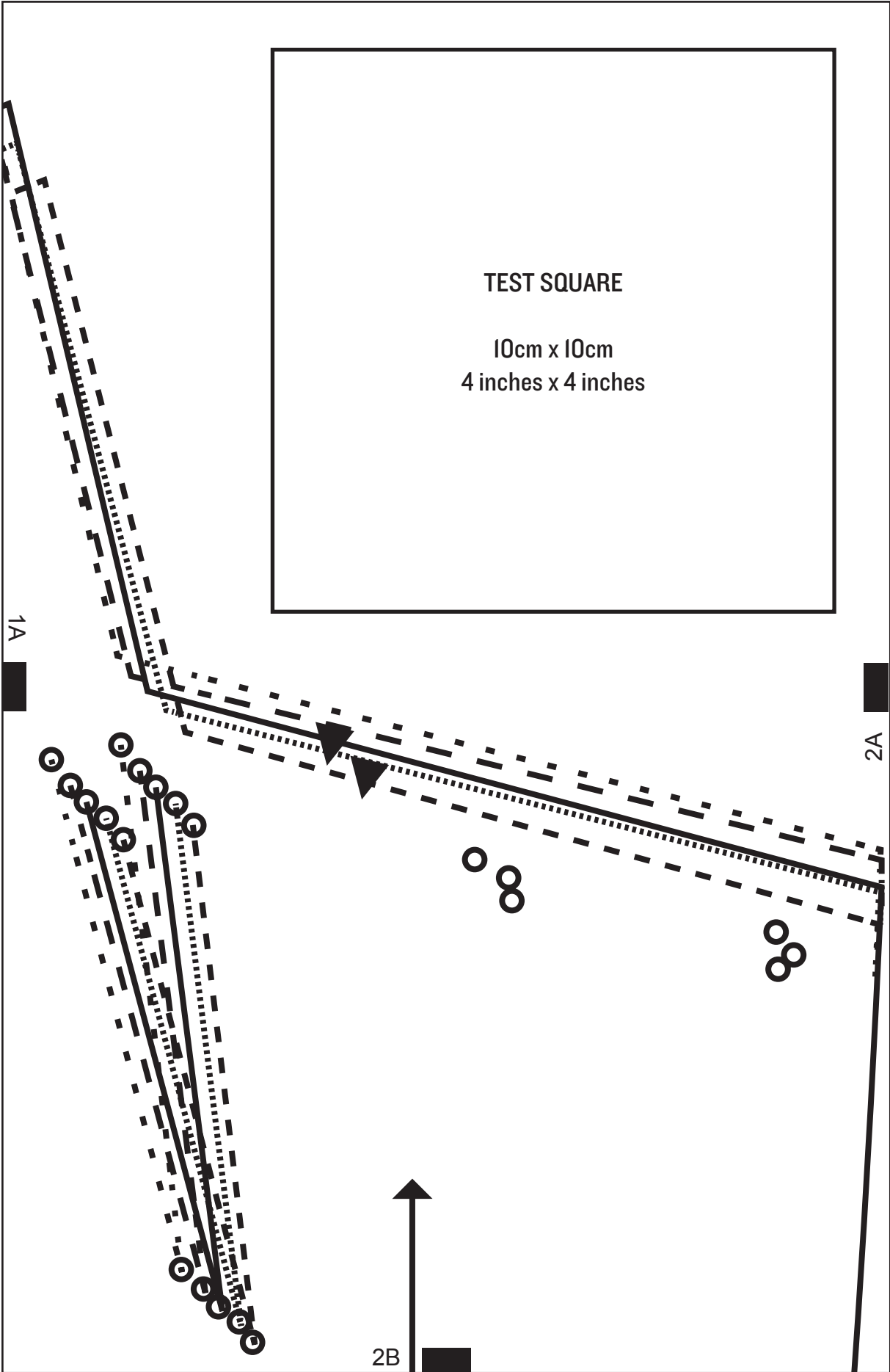

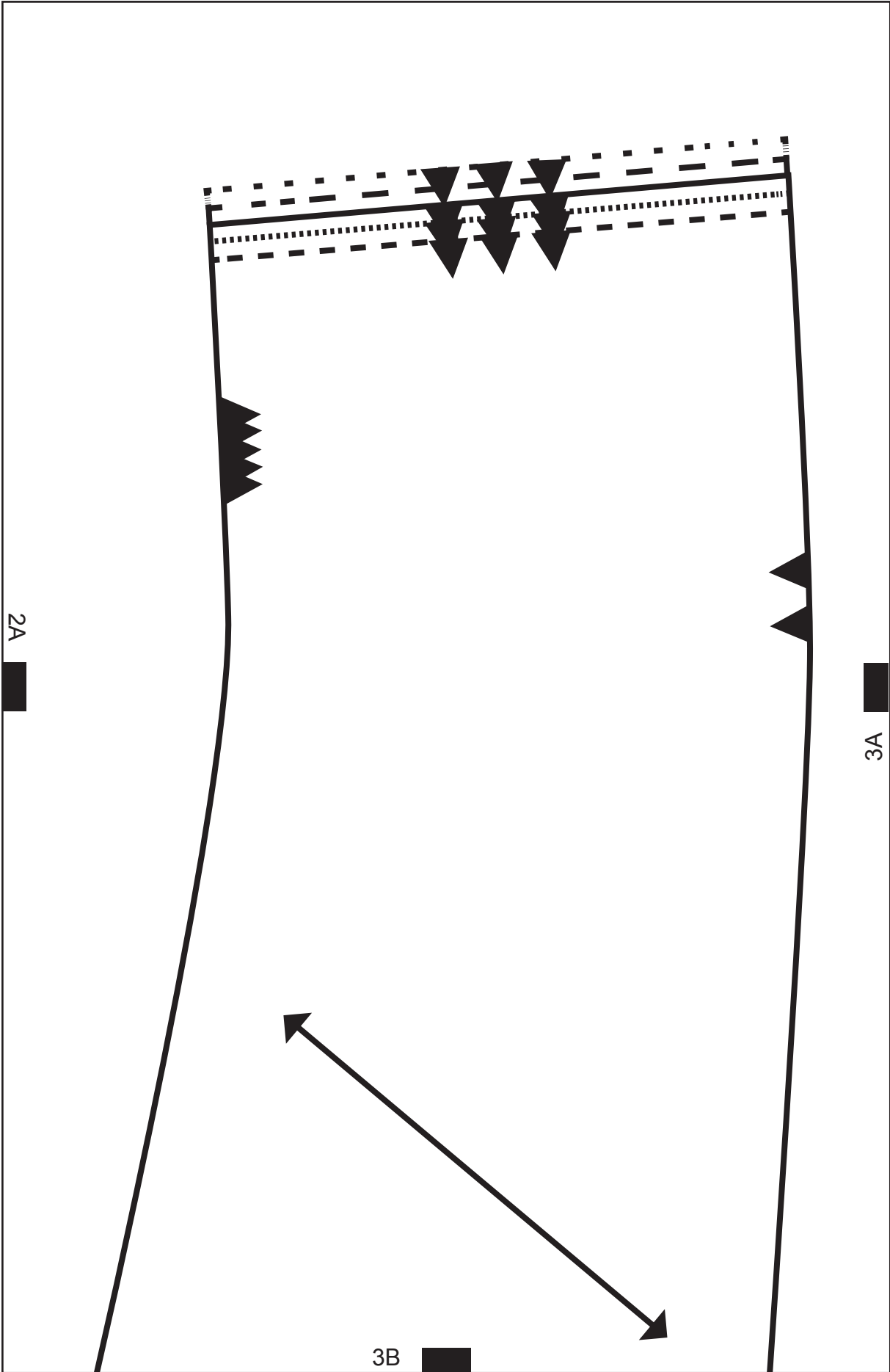

2A

3A

3B

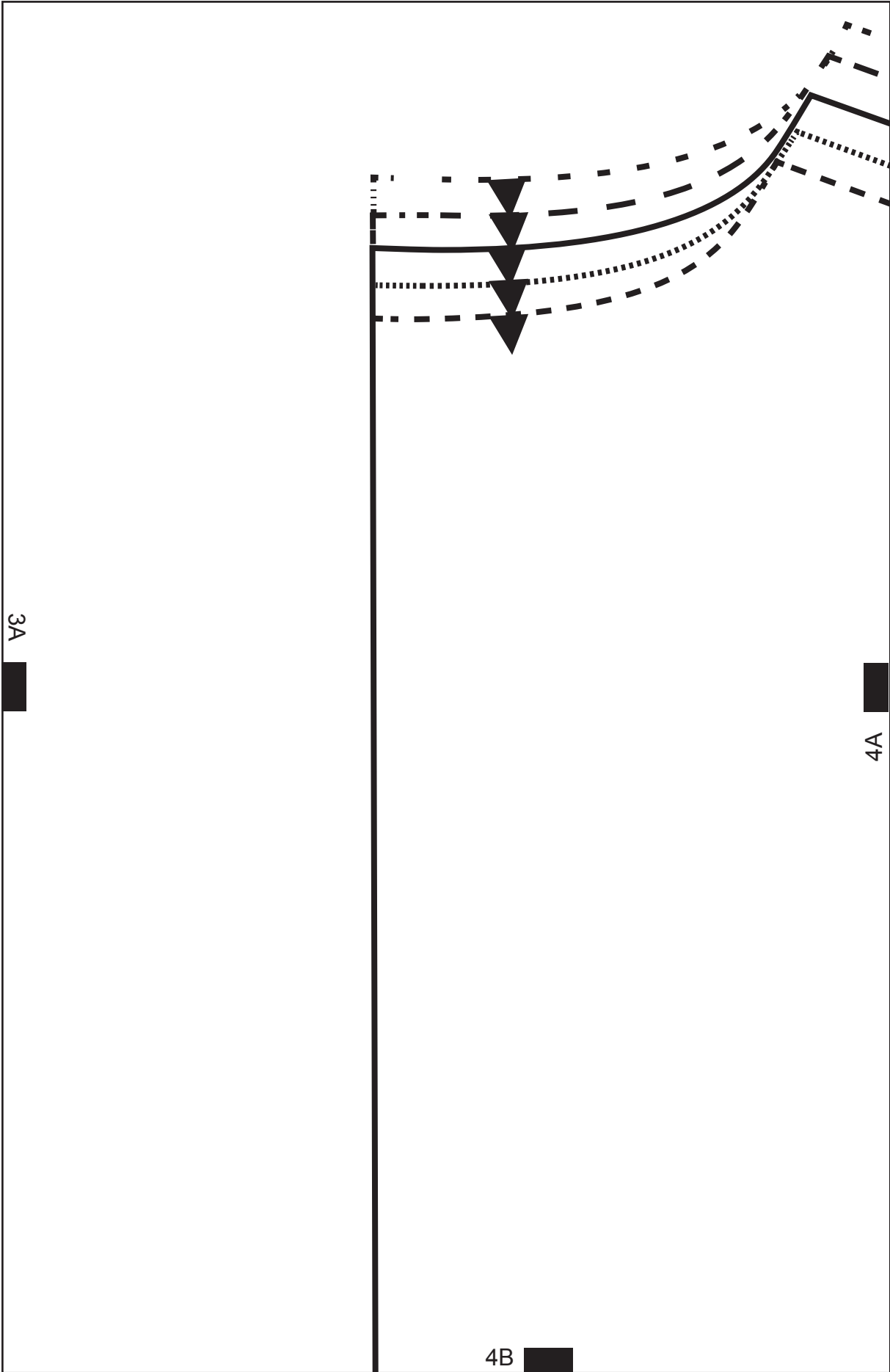

3A

4A

4B

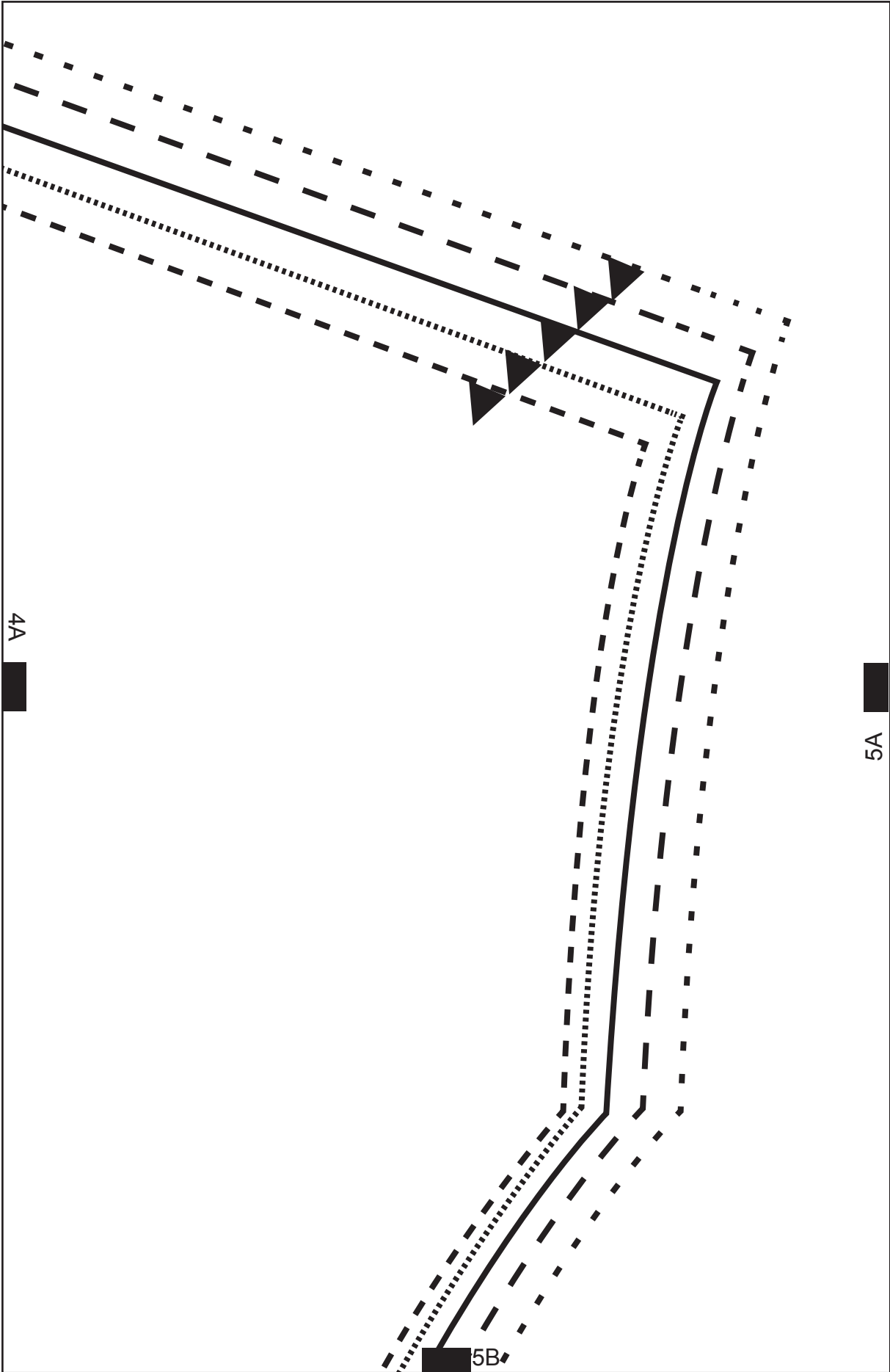

- 8 - - - - -
- 10 ·····
- 12 ———
- 14 - - - - -
- 16 ·····

5A



6A



6B

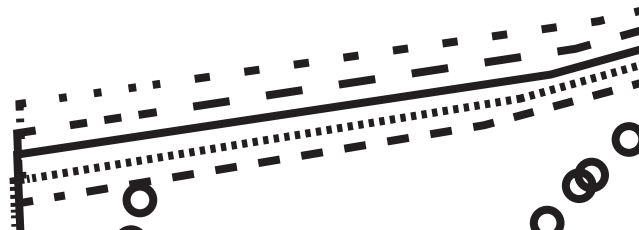

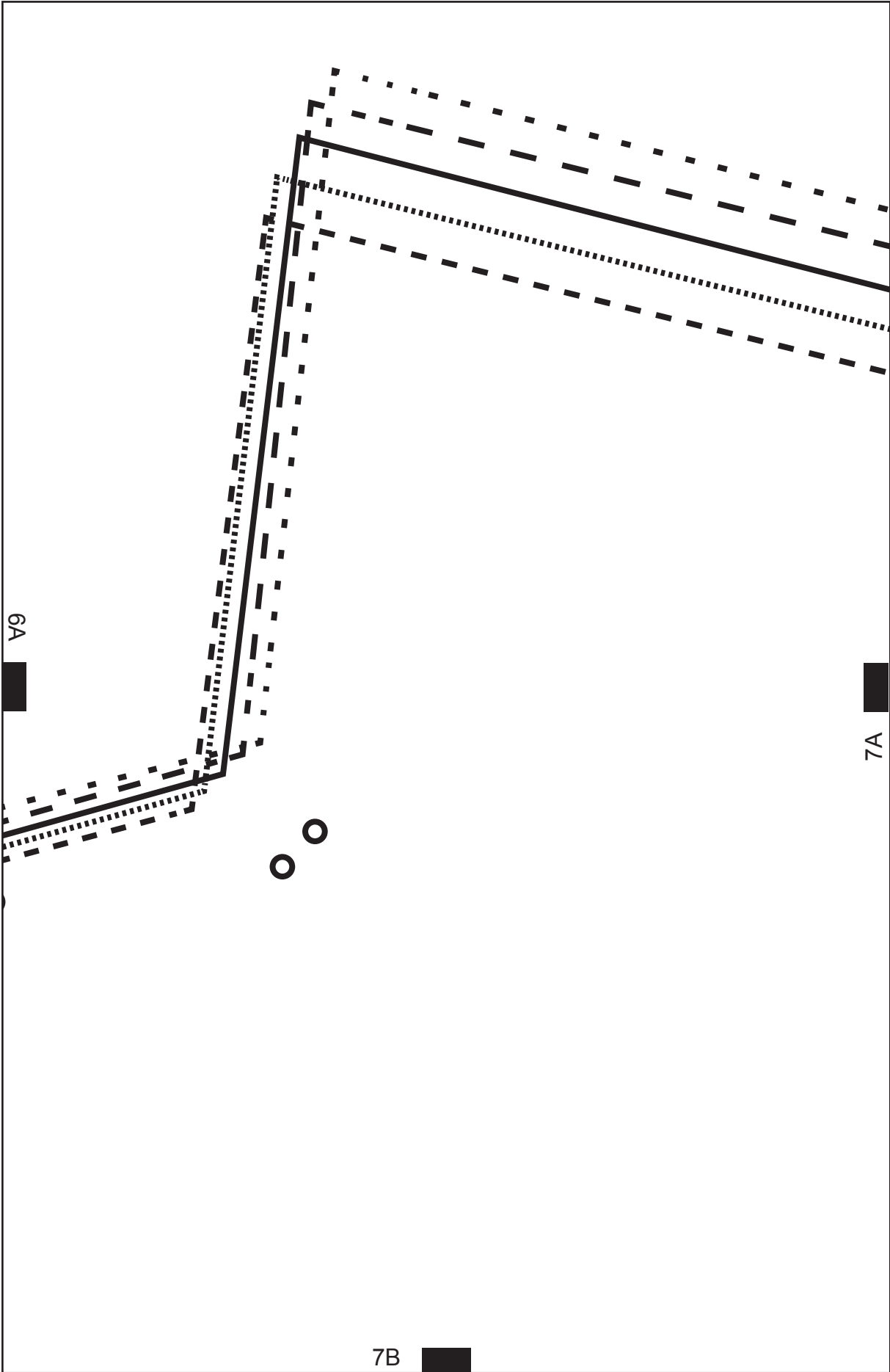

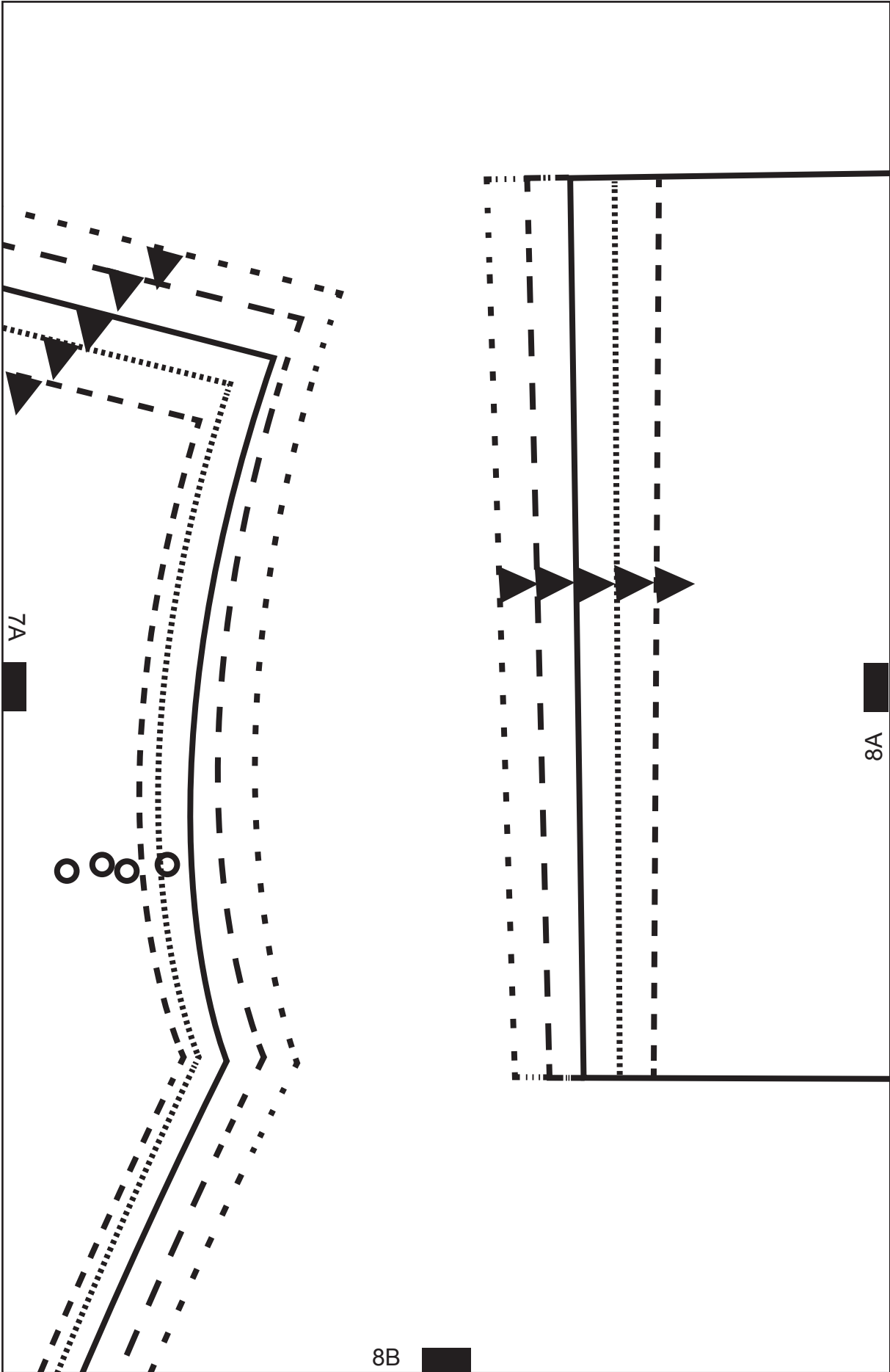

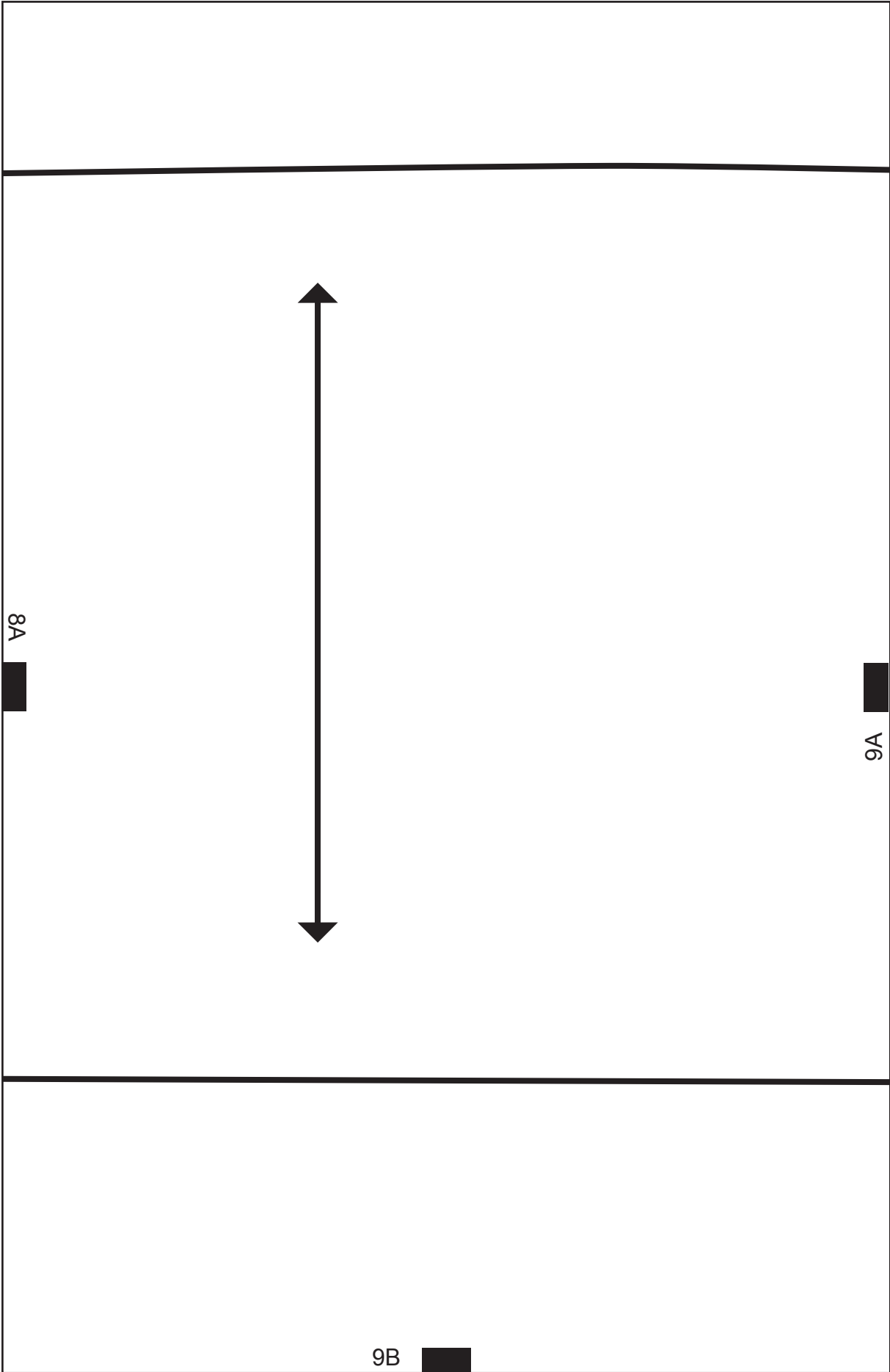

8A

9A

9B

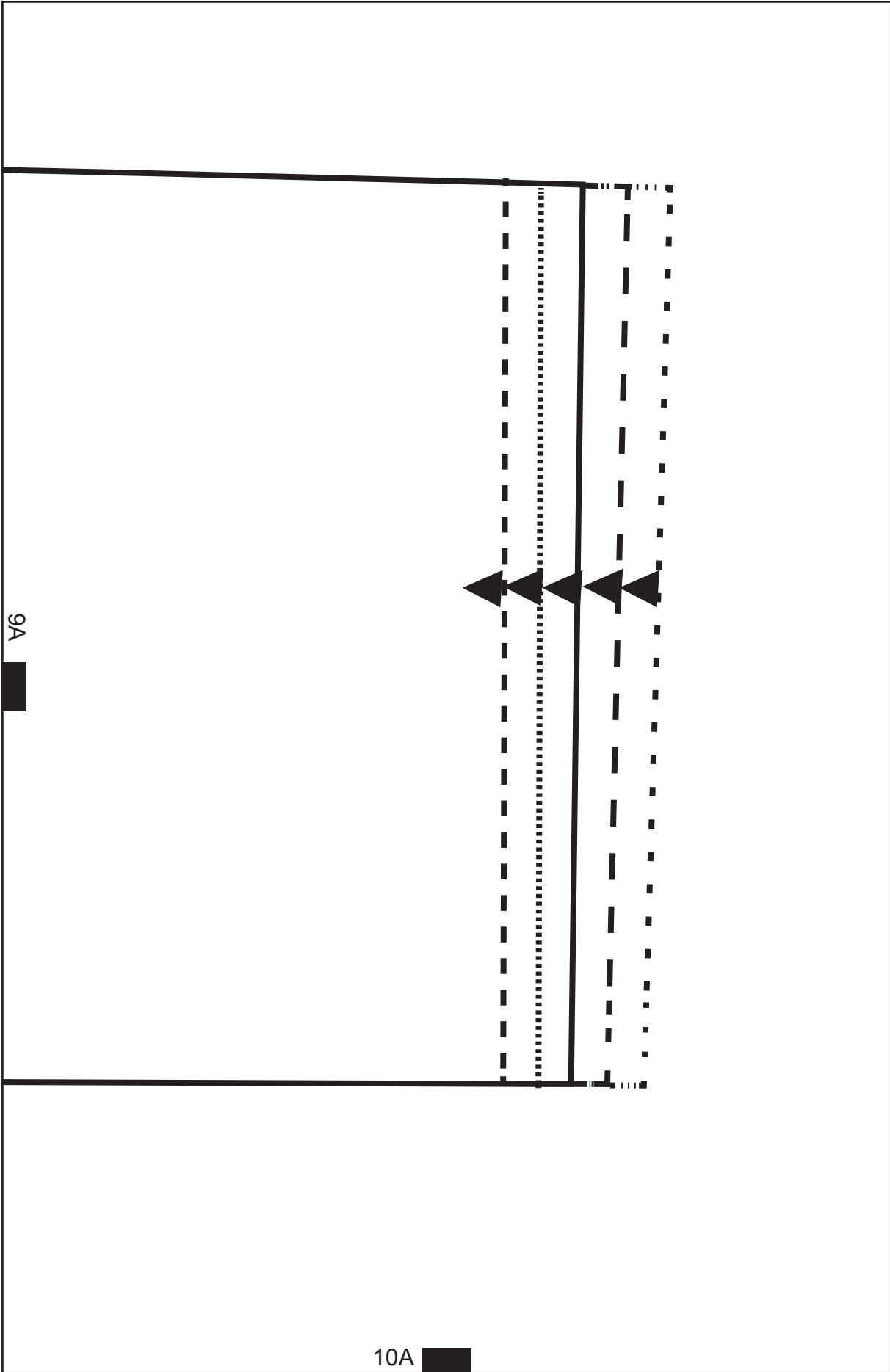

9A

10A

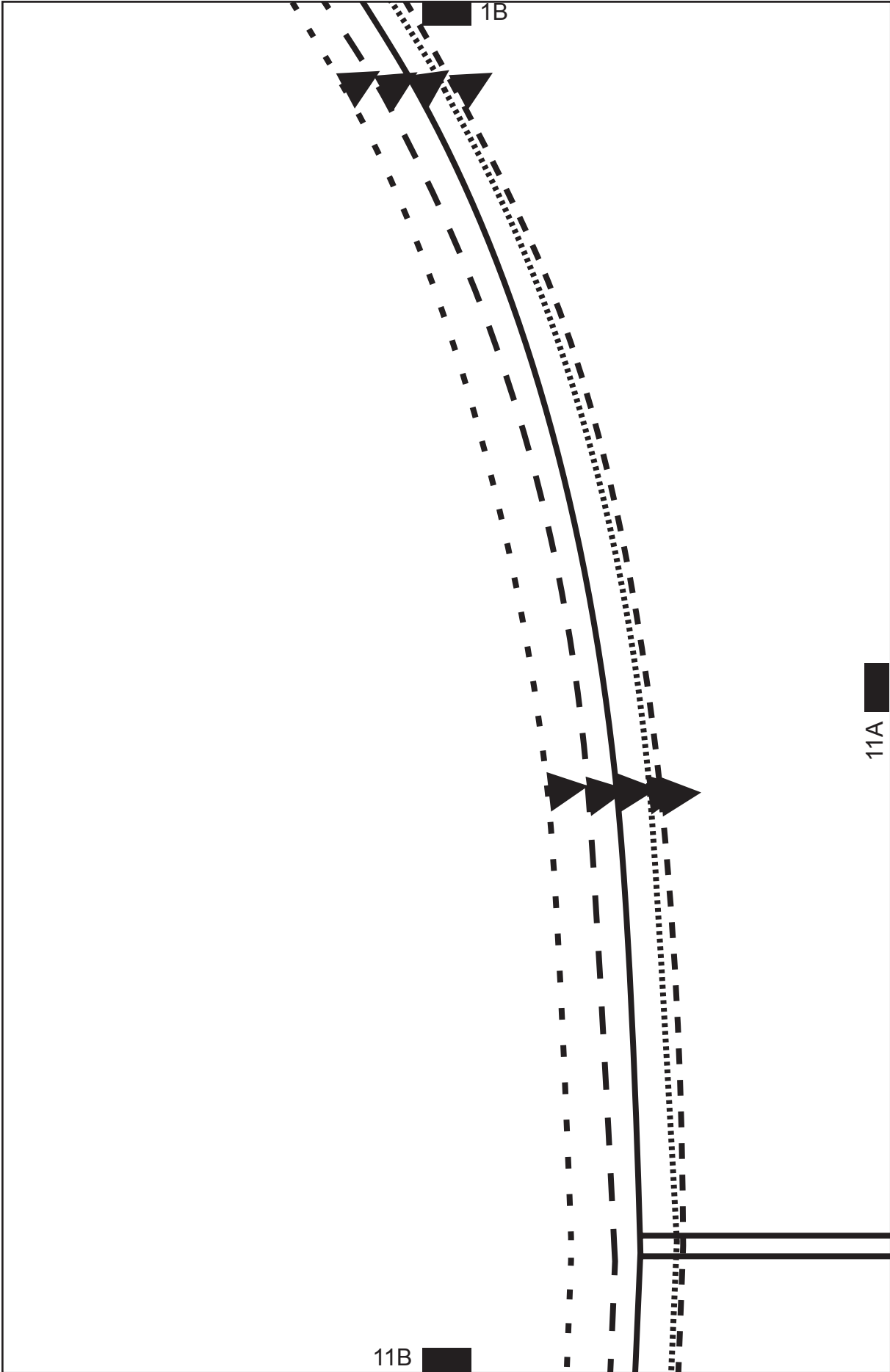

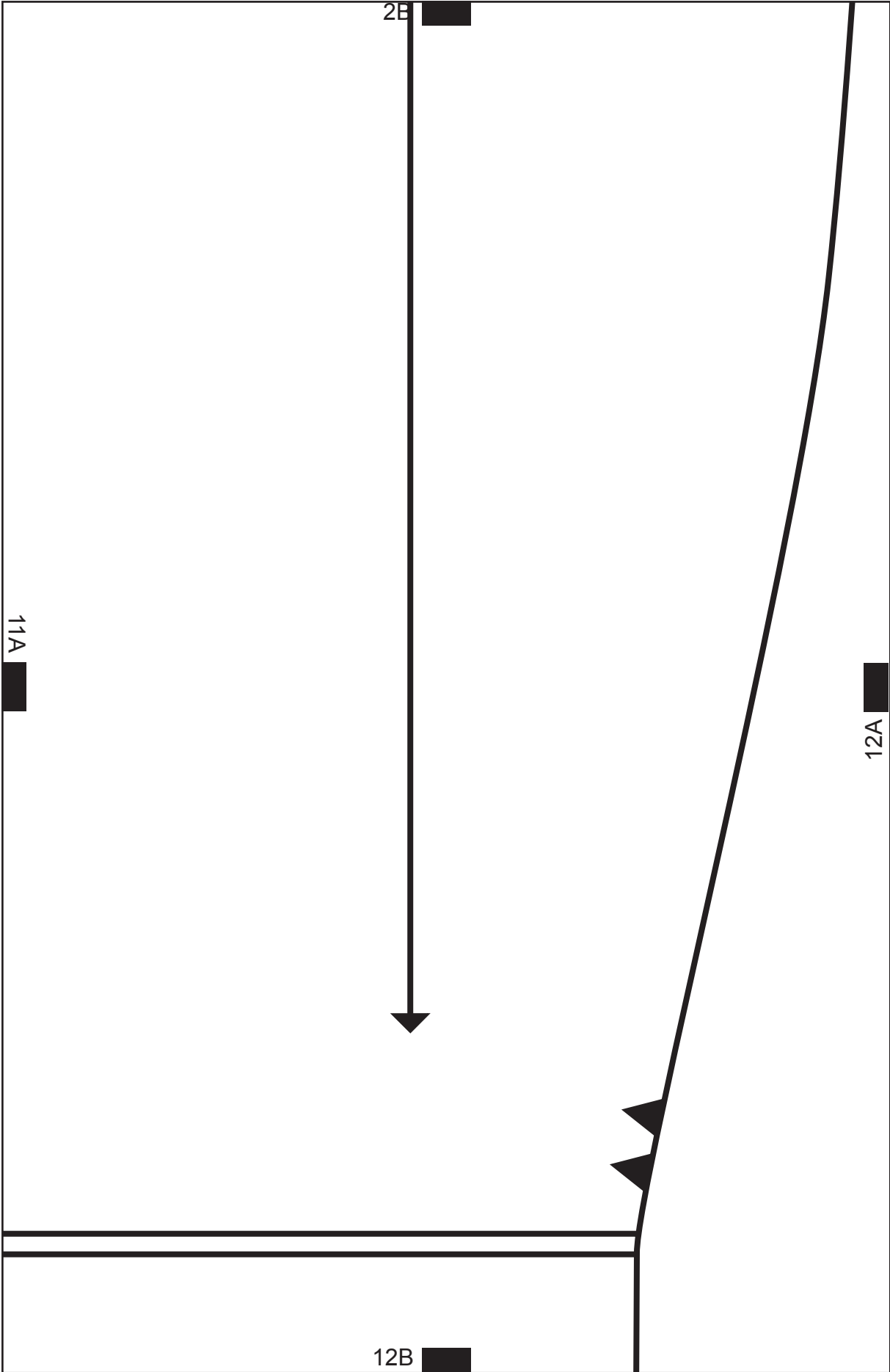

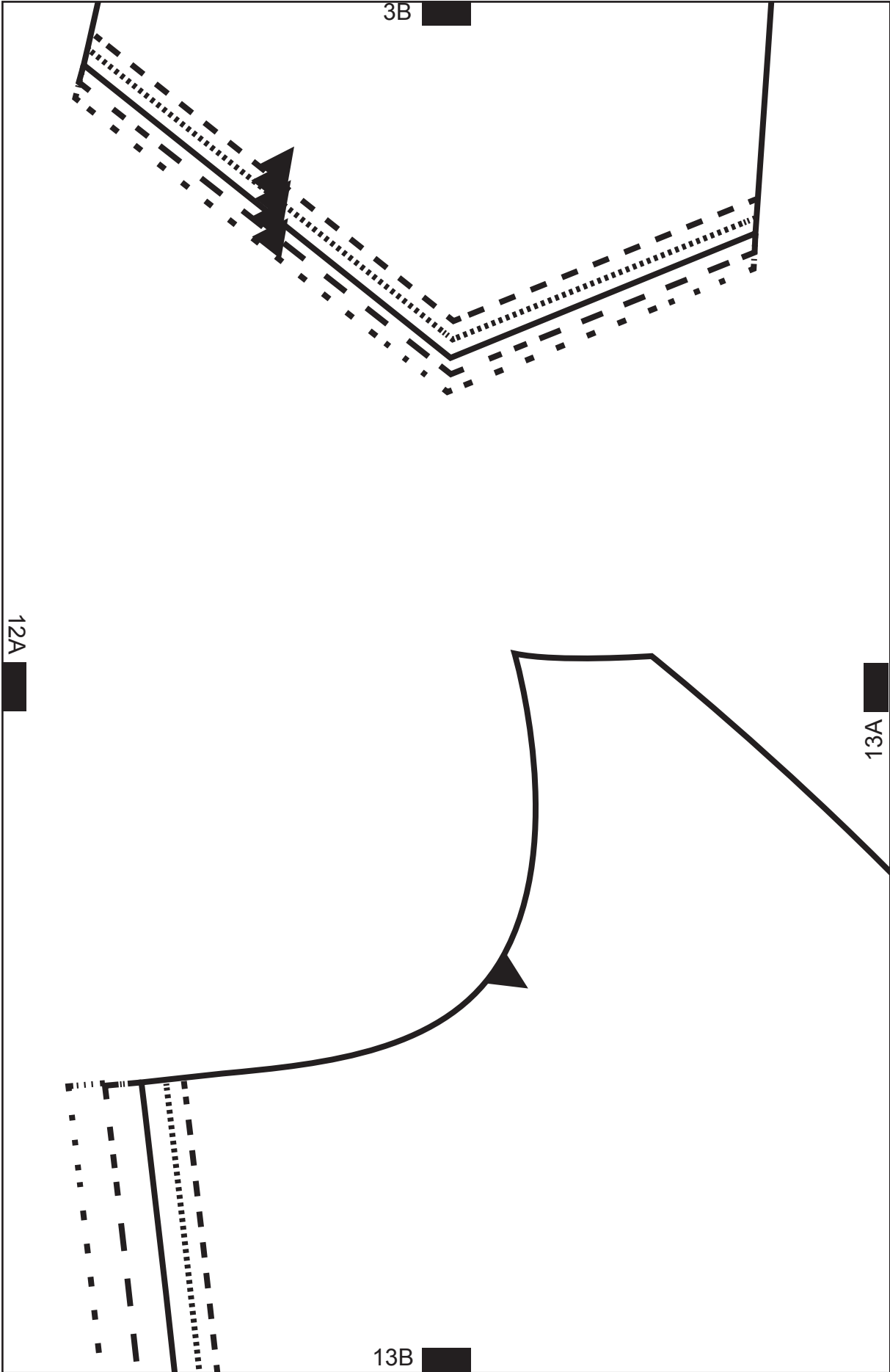

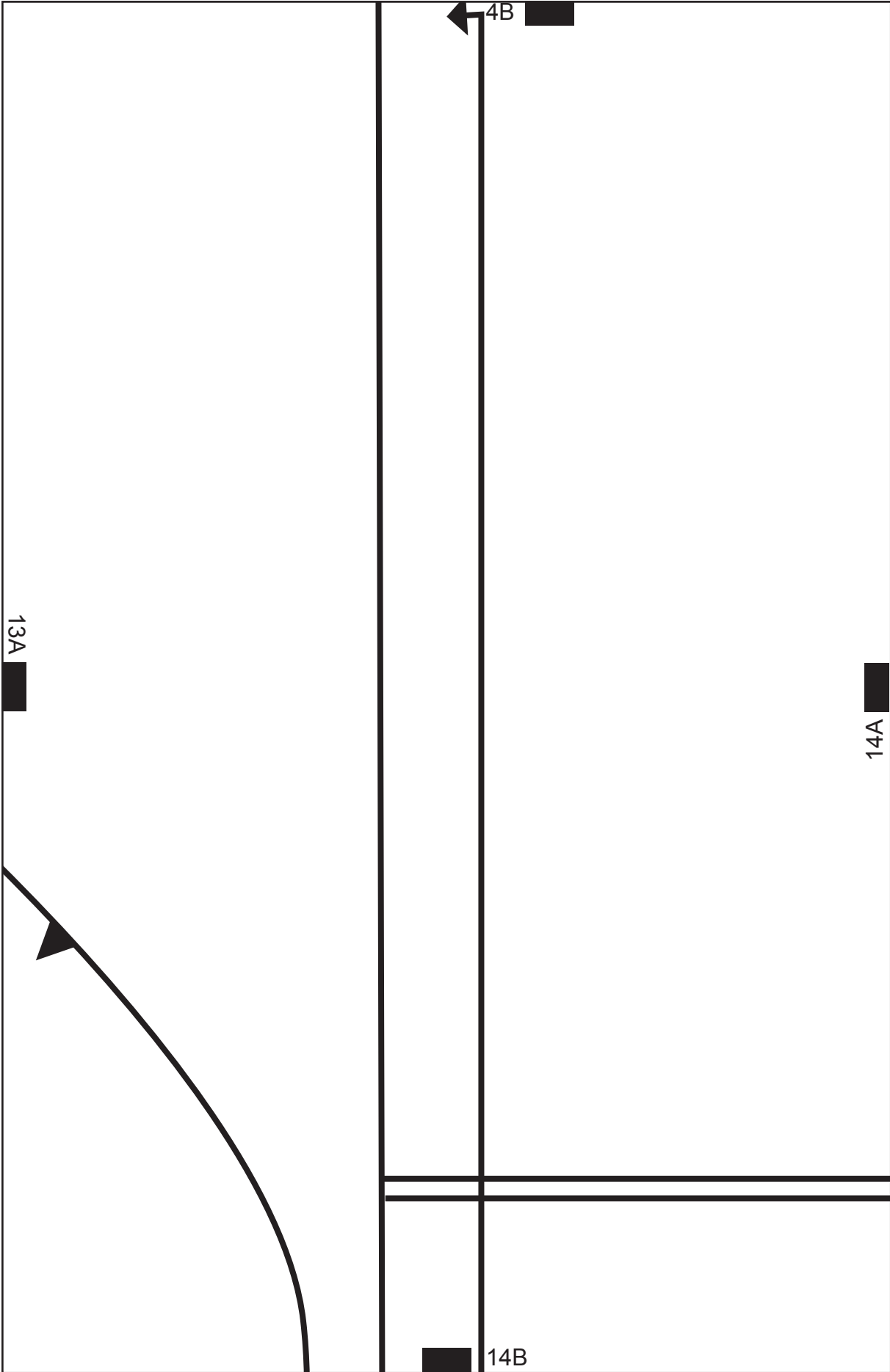

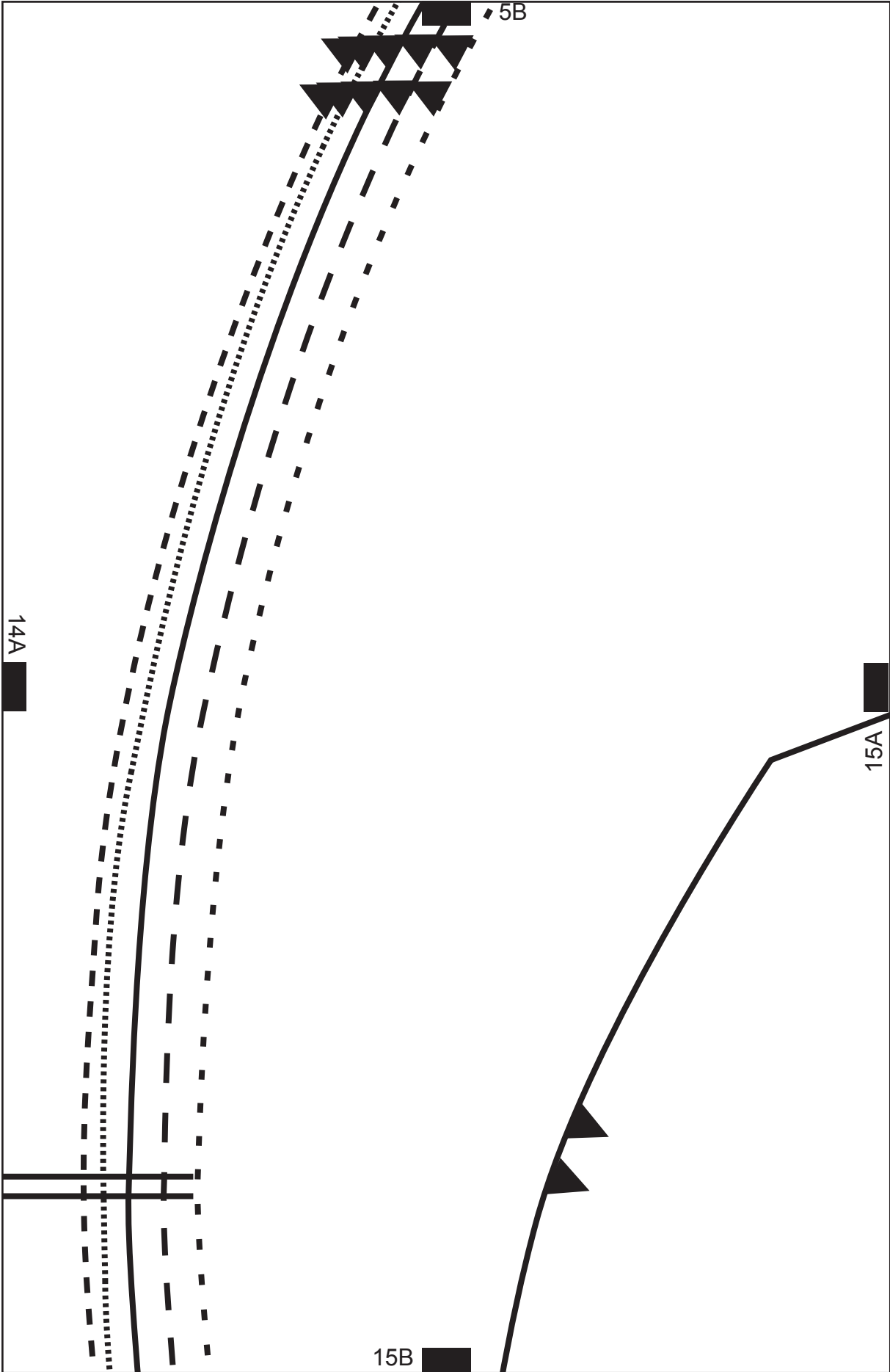

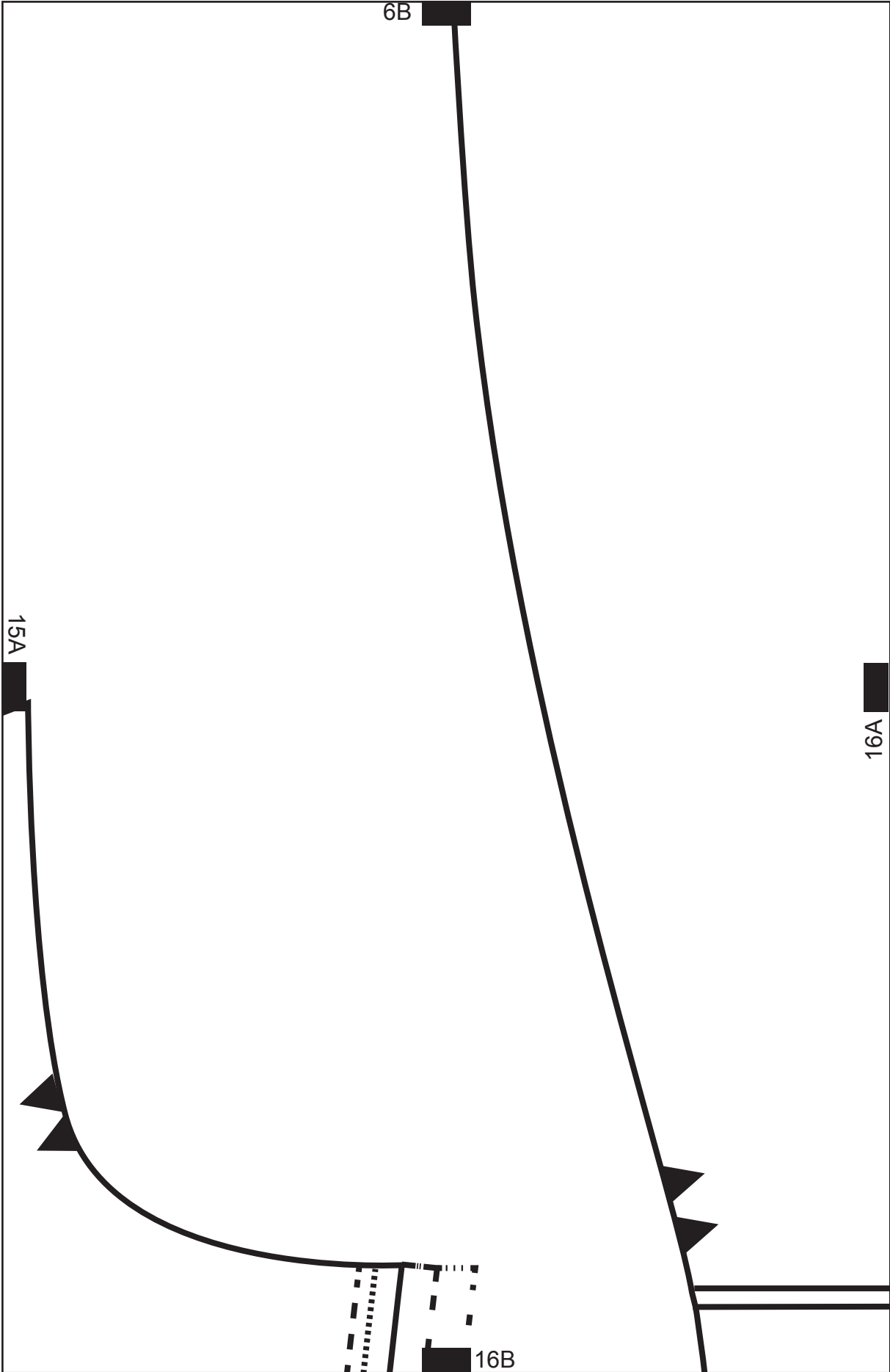

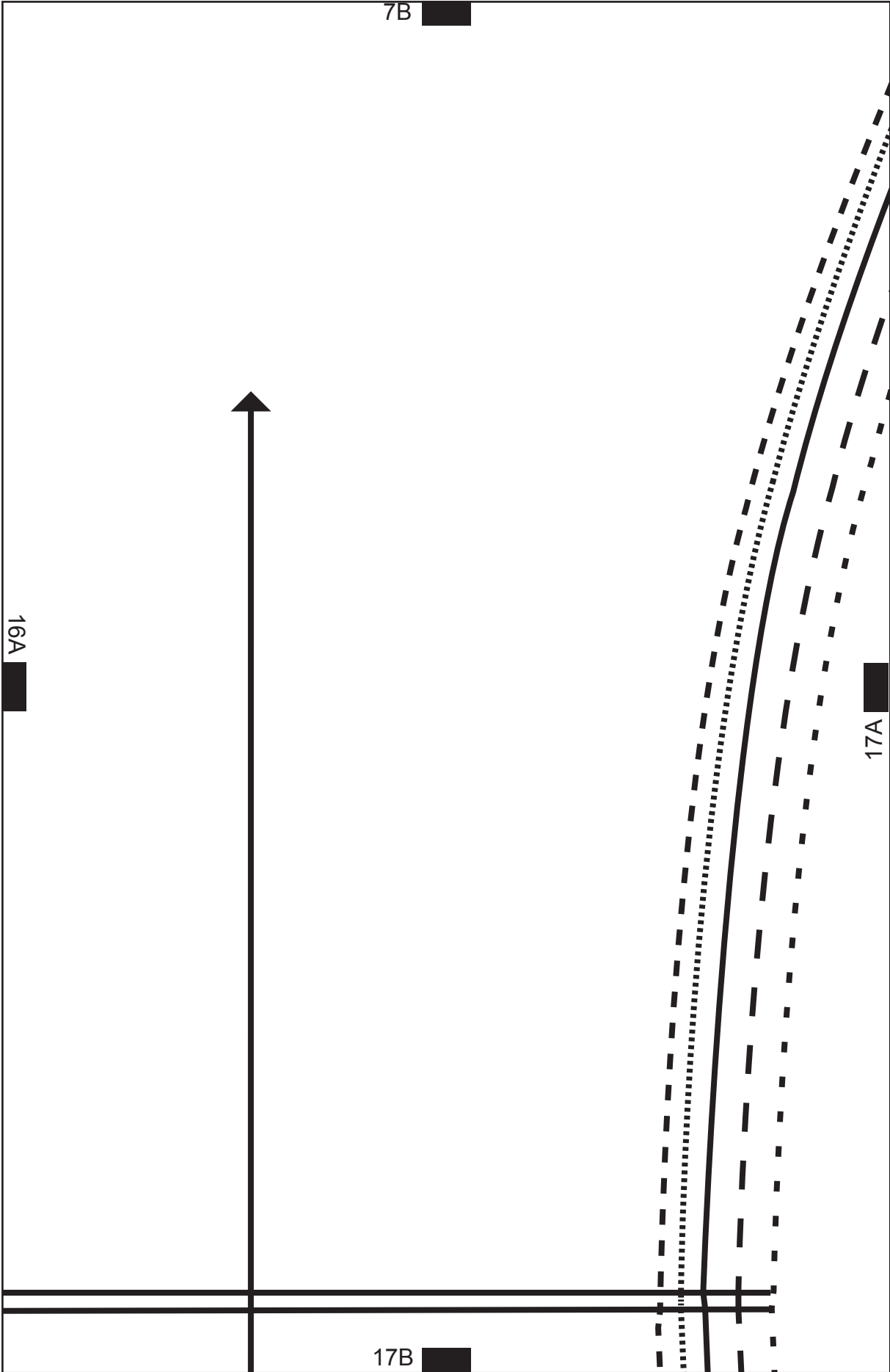

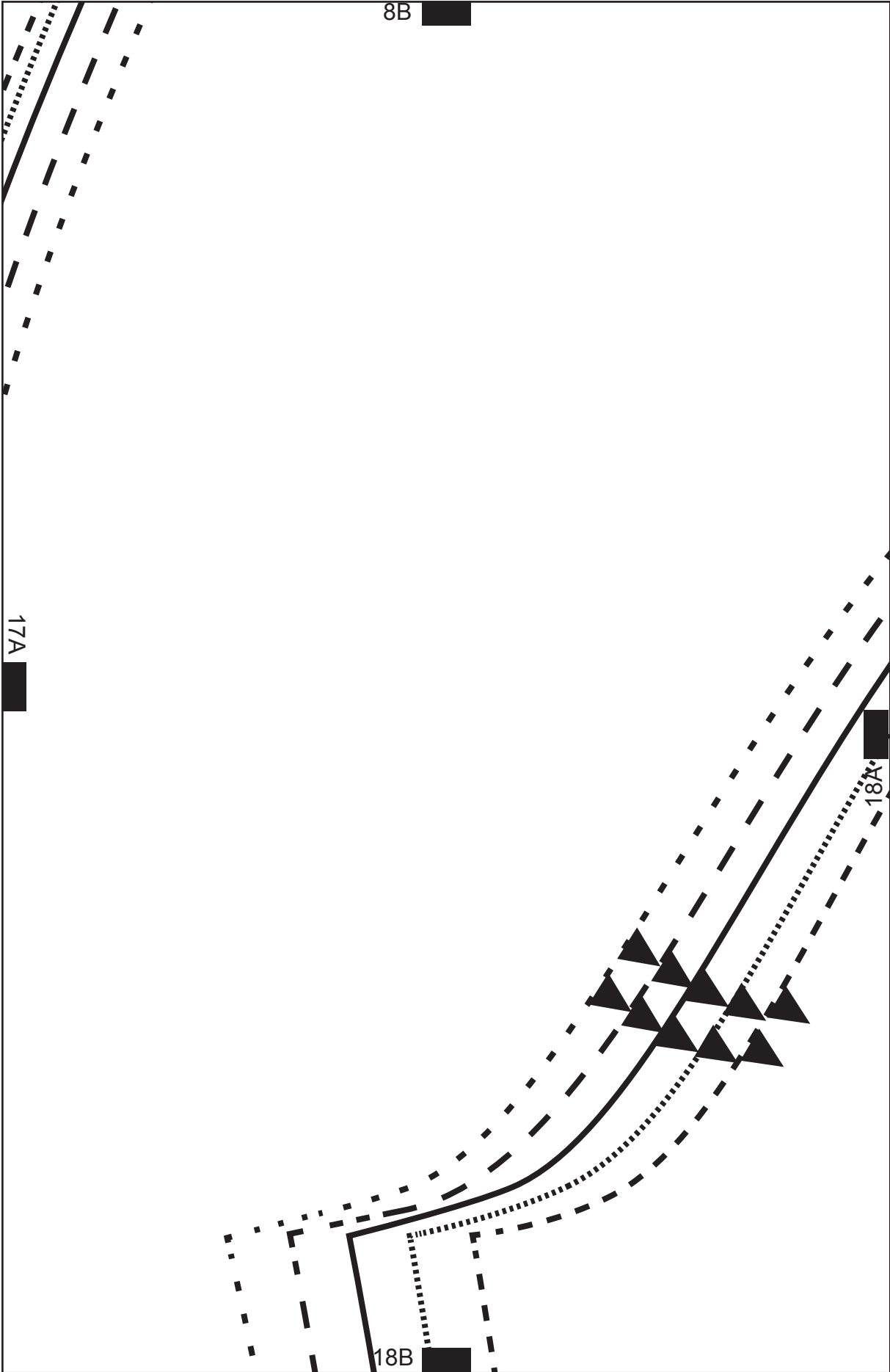

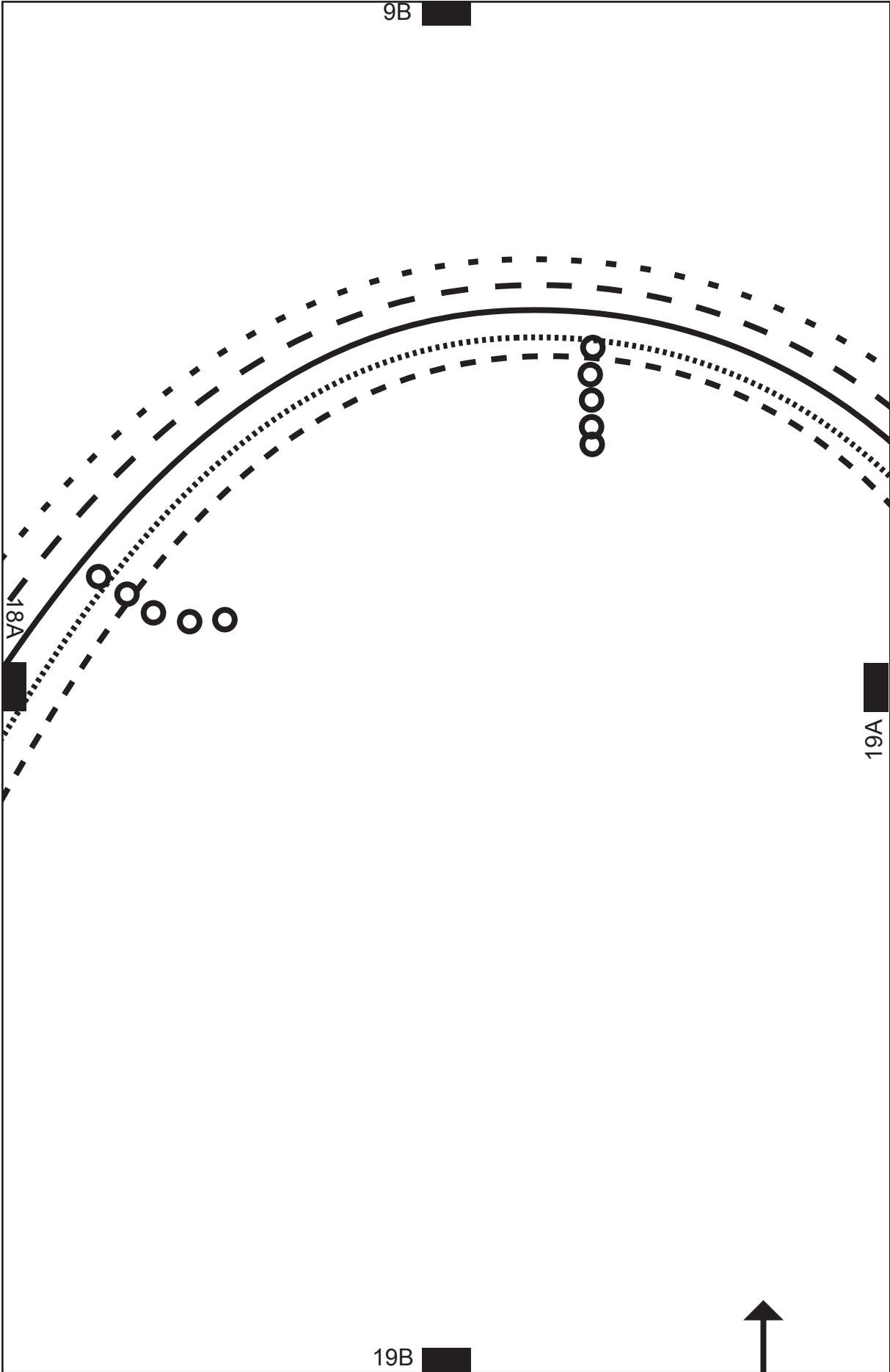

10A 

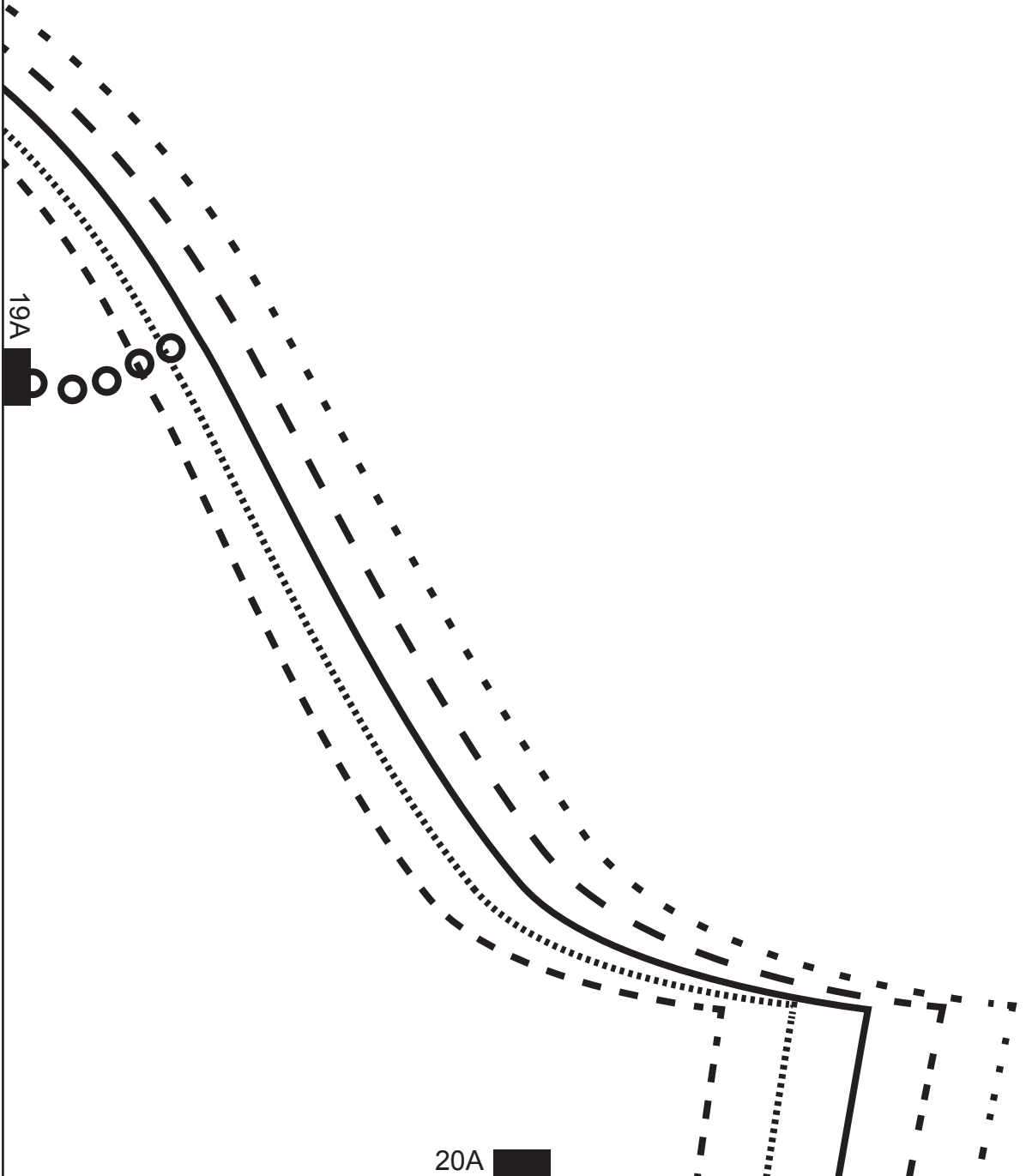

19A 

20A 

11B

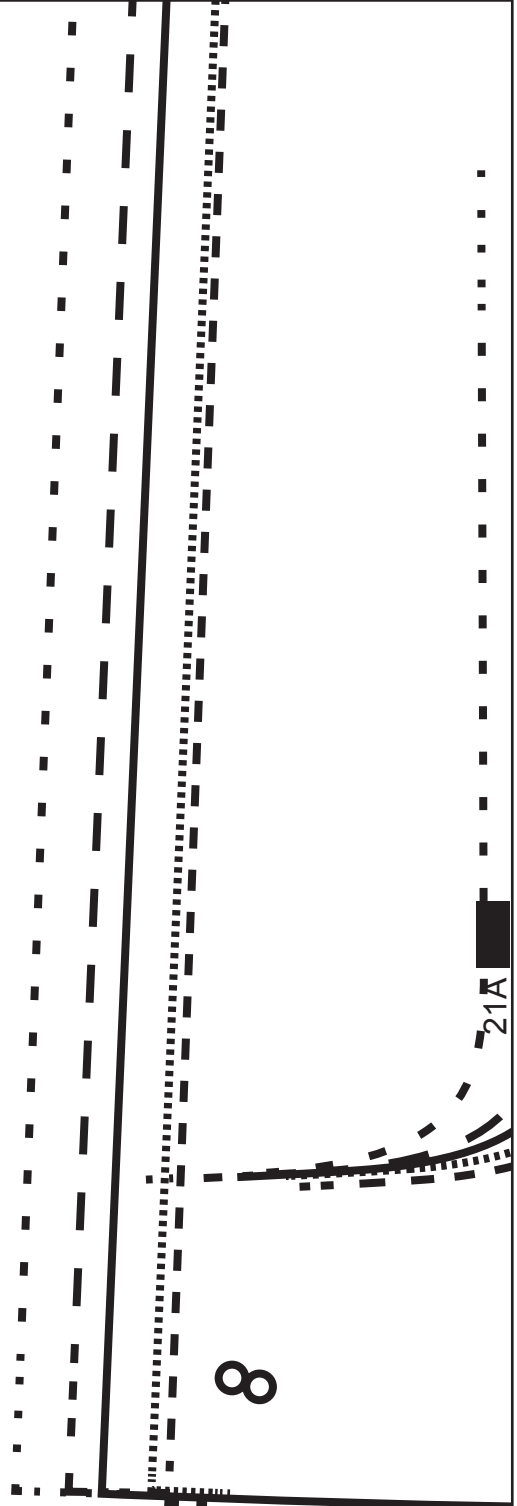

21A

21B

12B



21A

22B

22A

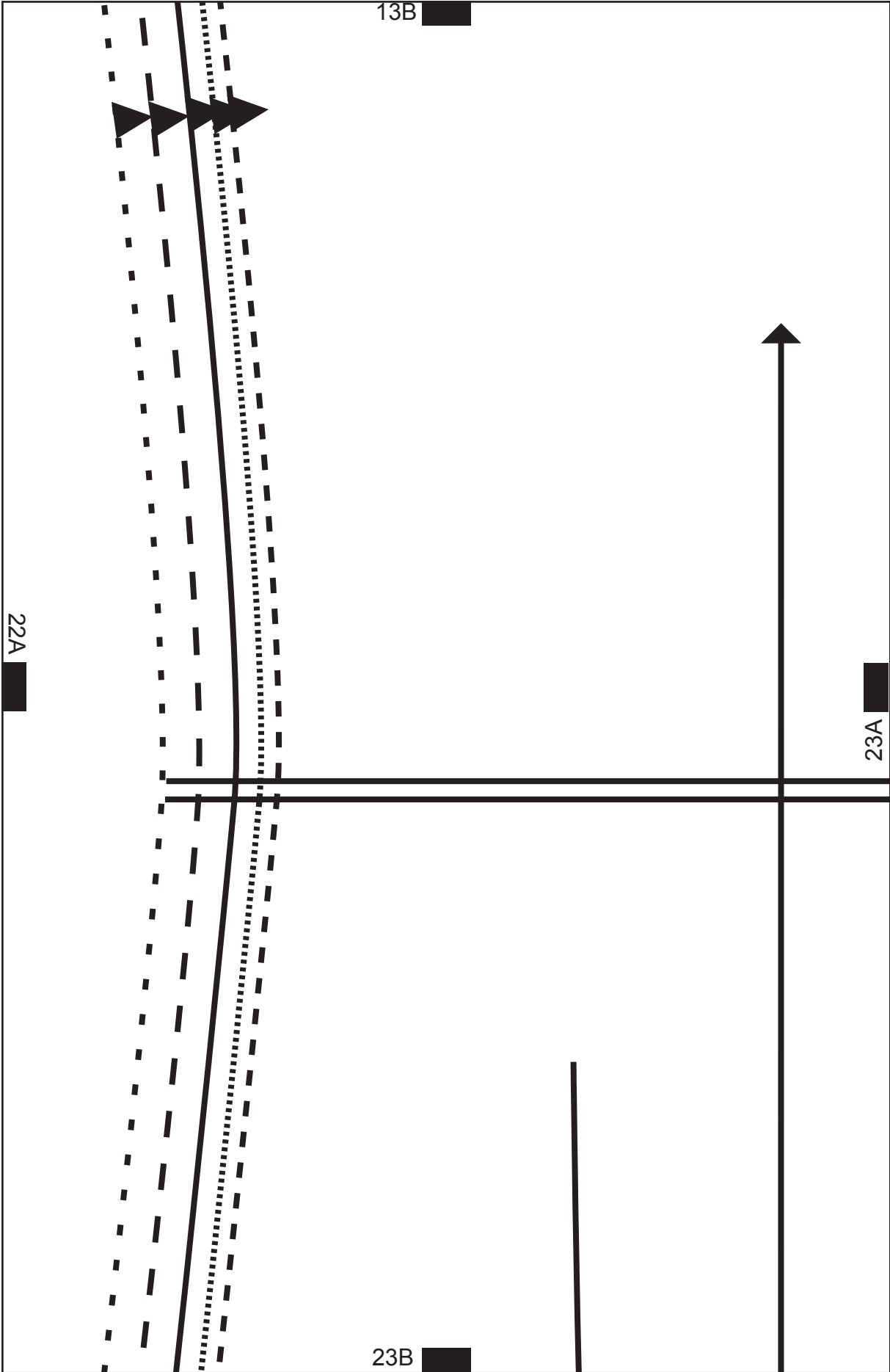

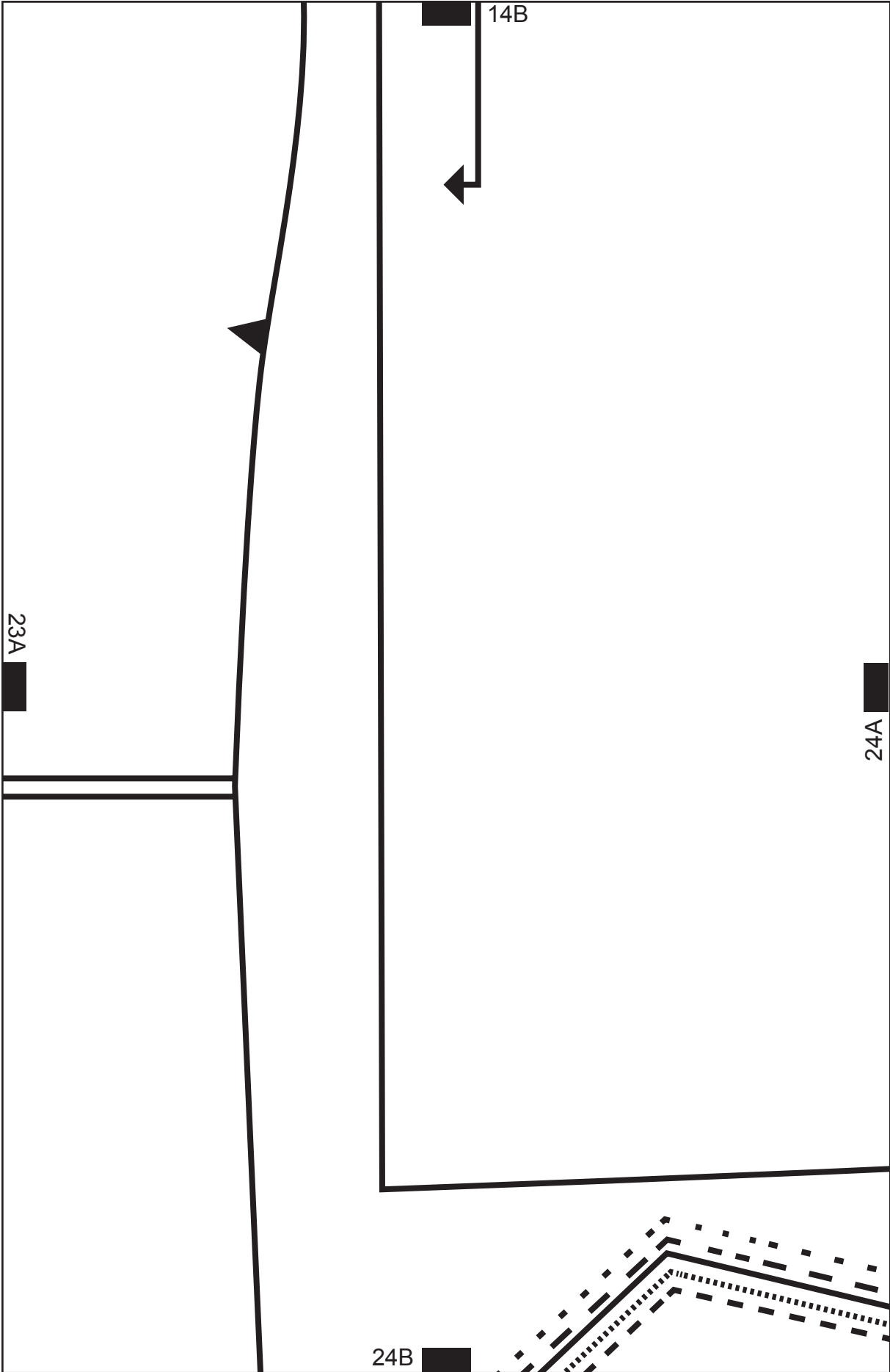

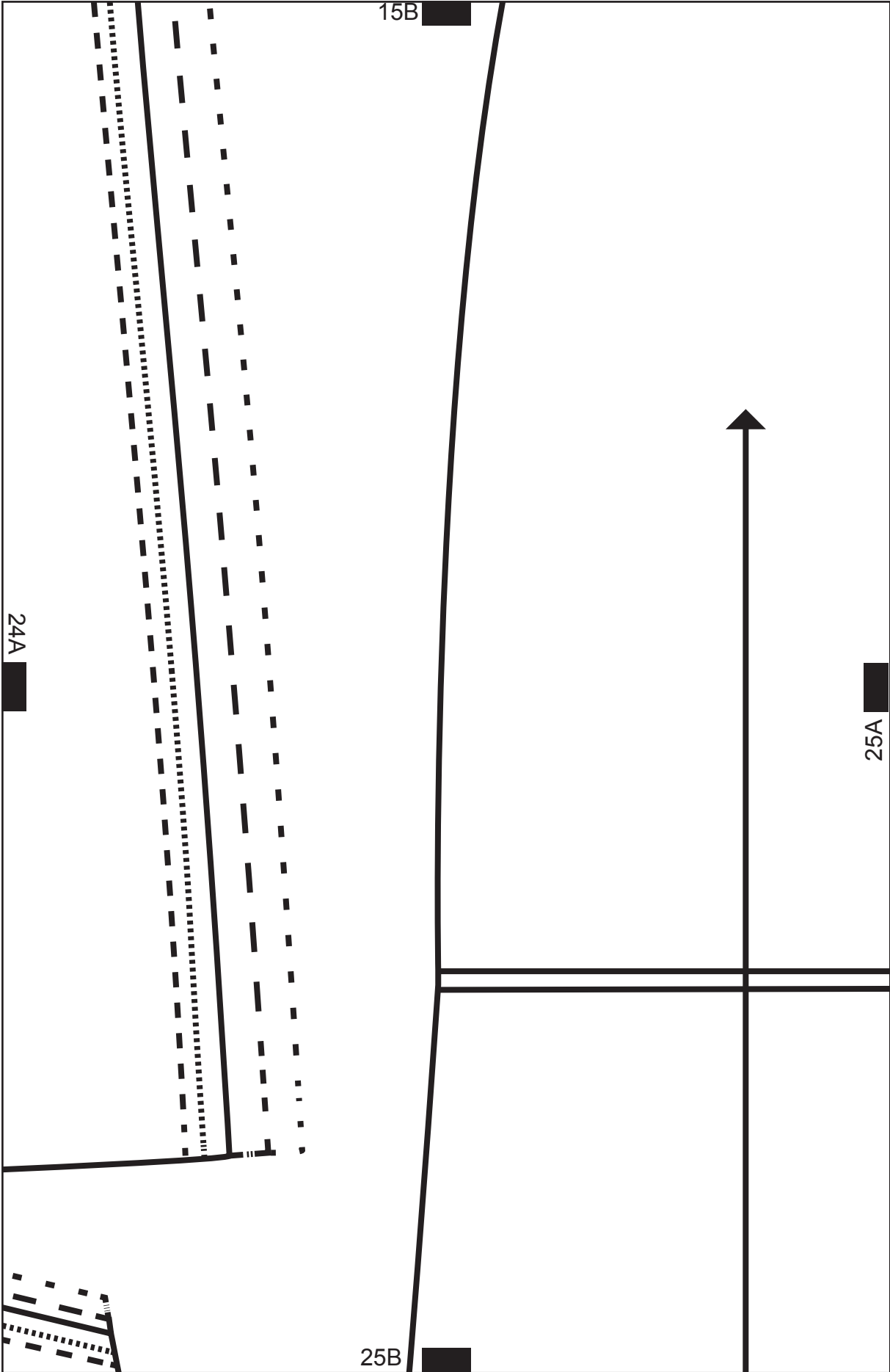

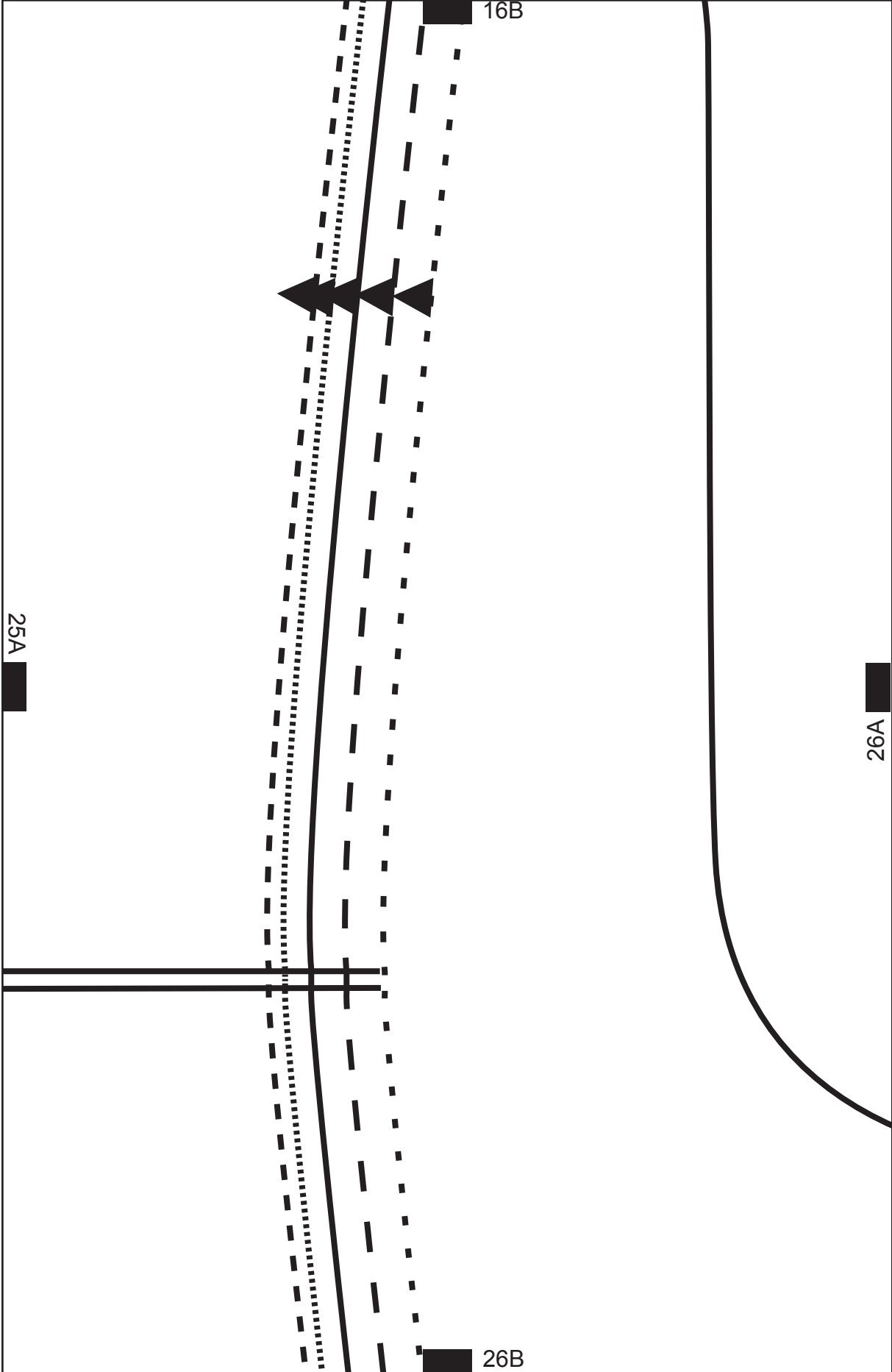

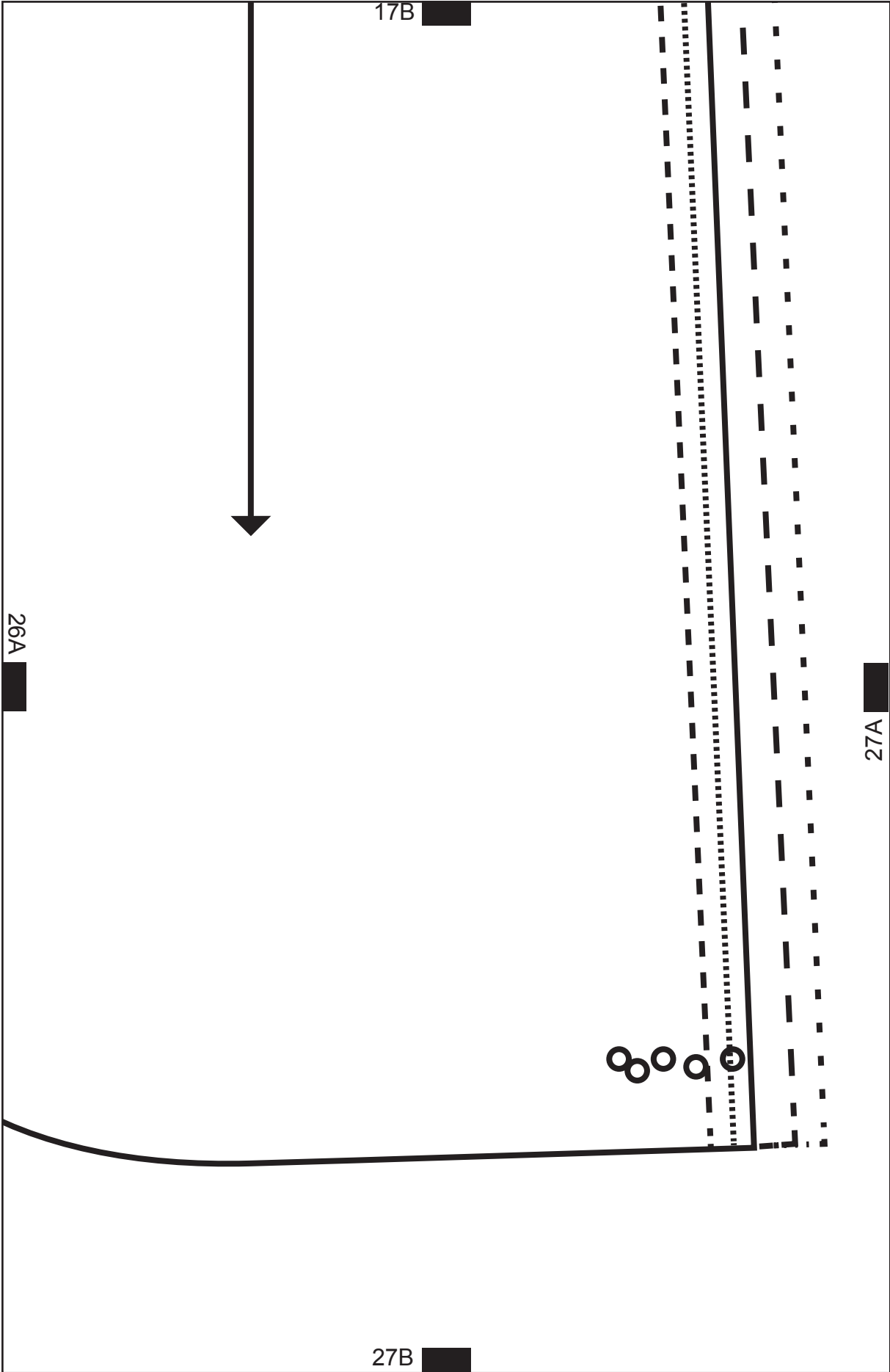

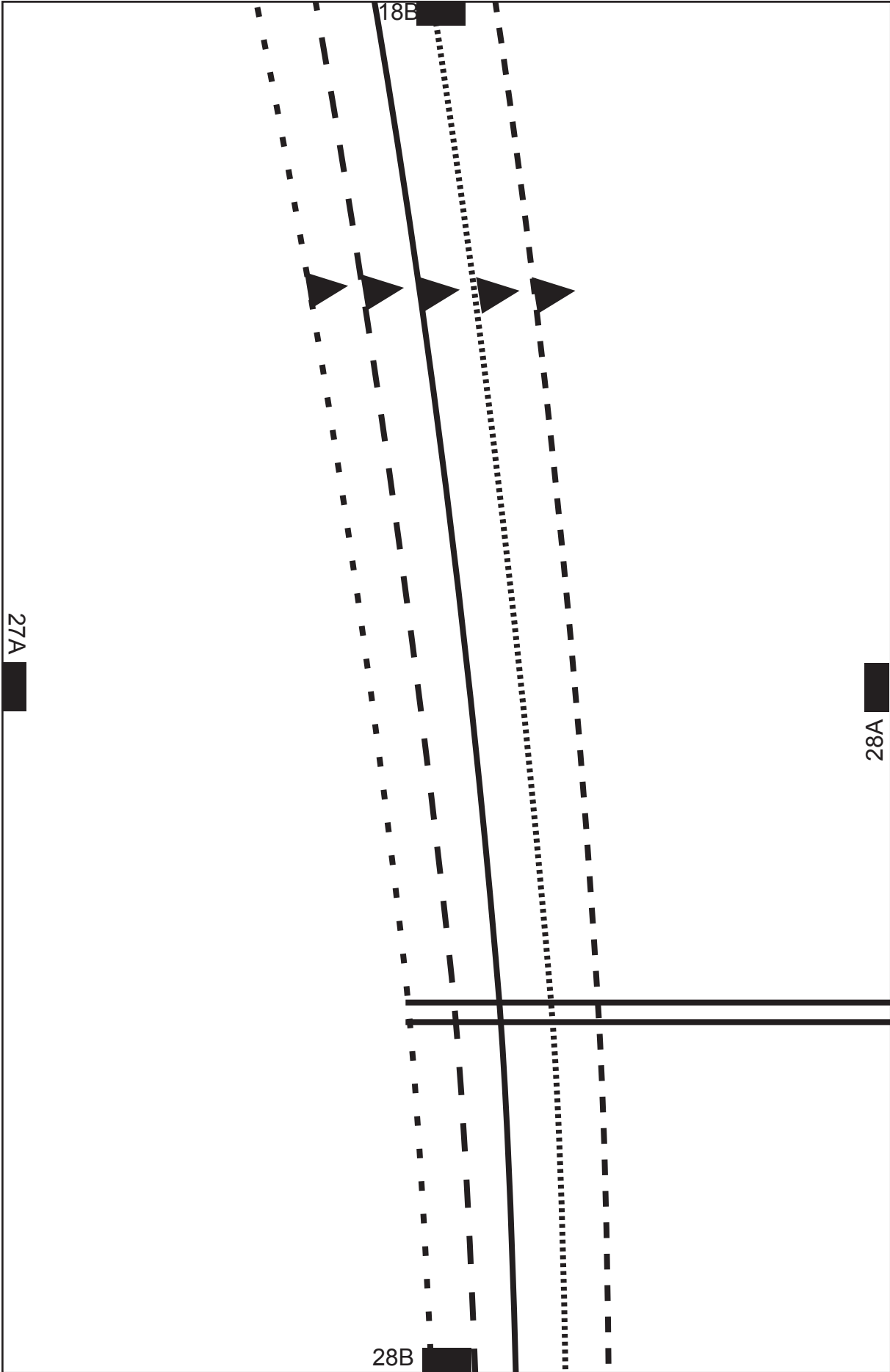

27A

18B

28A

28B

19B ■

28A ■

29A ■

29B ■

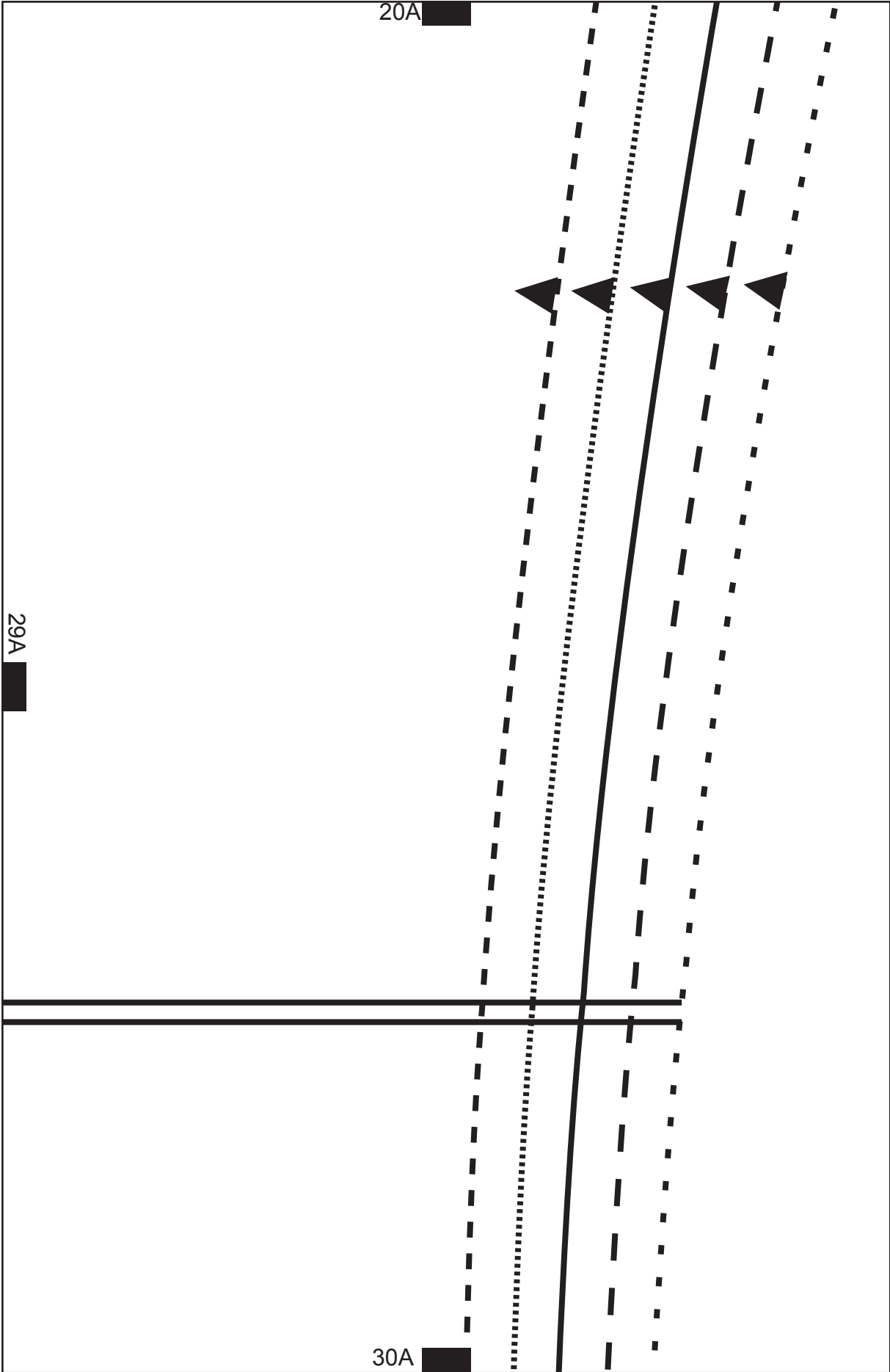

20A

29A

30A

21B

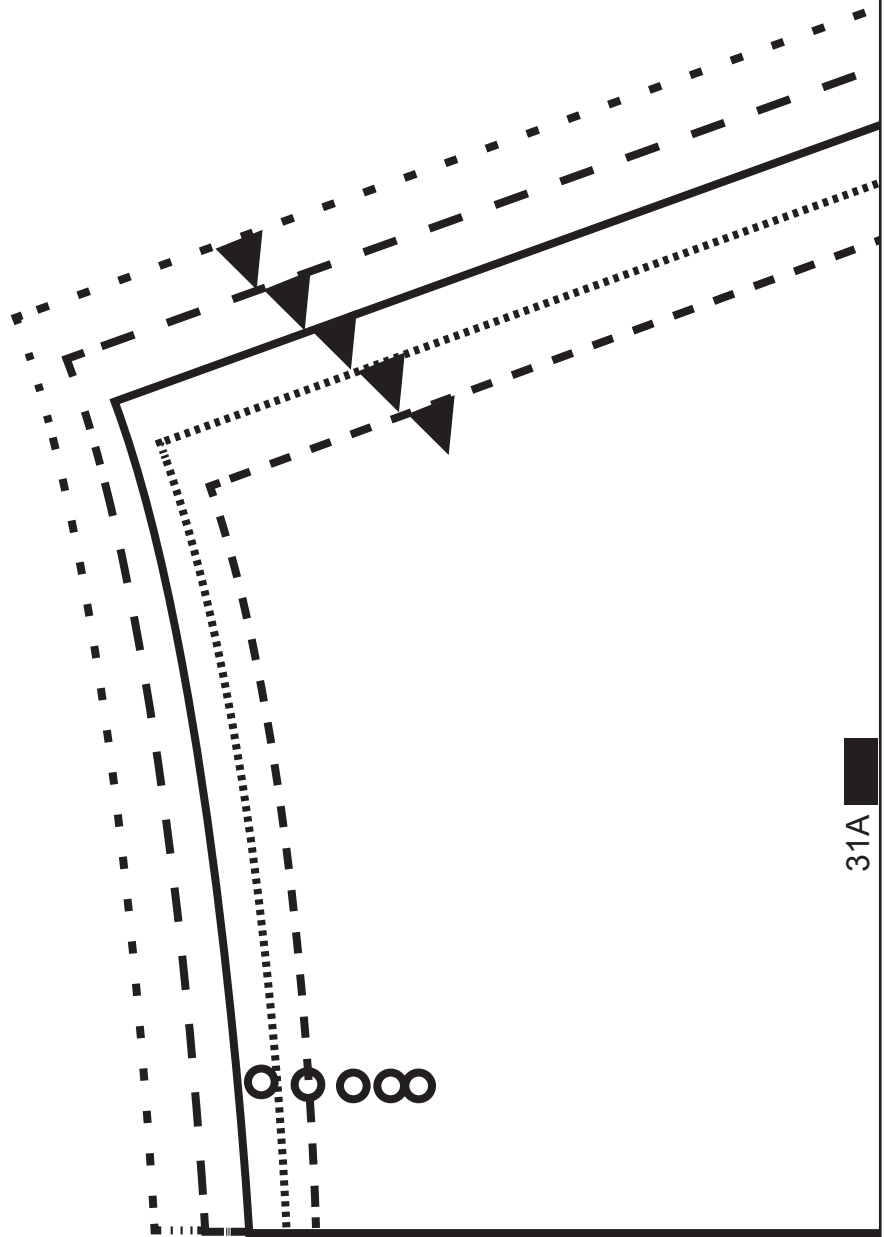

31A

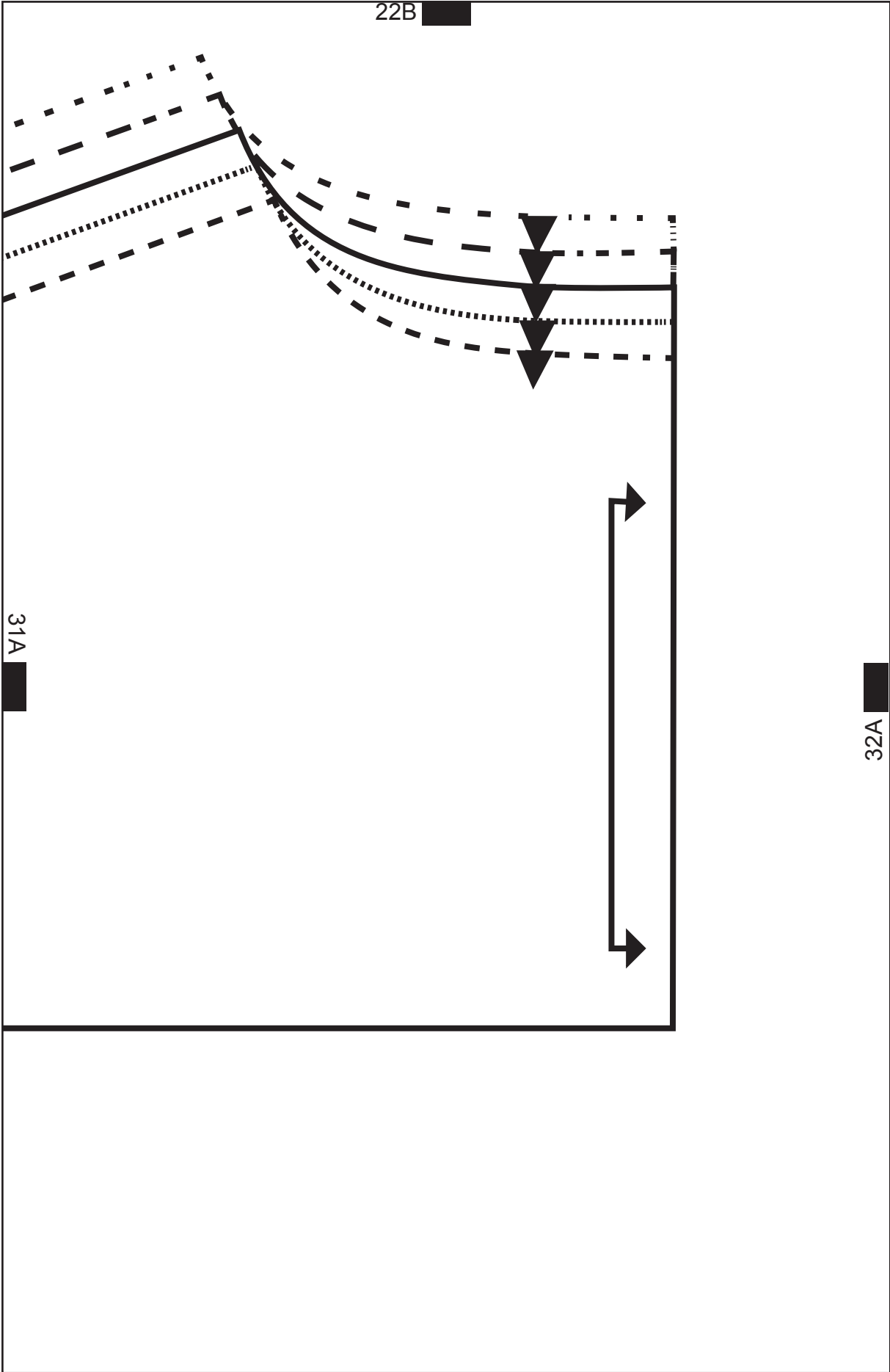

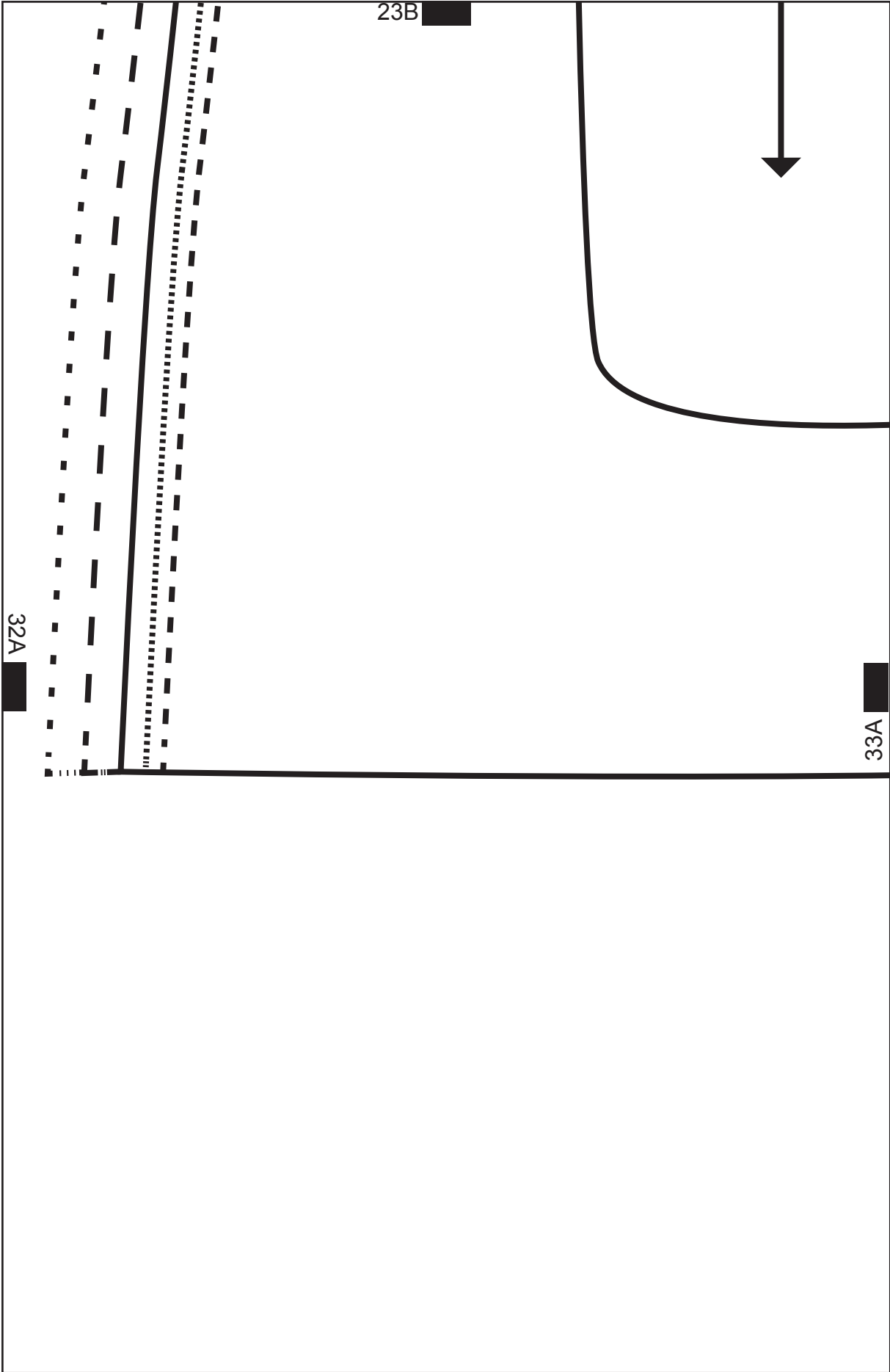

23B

32A

33A

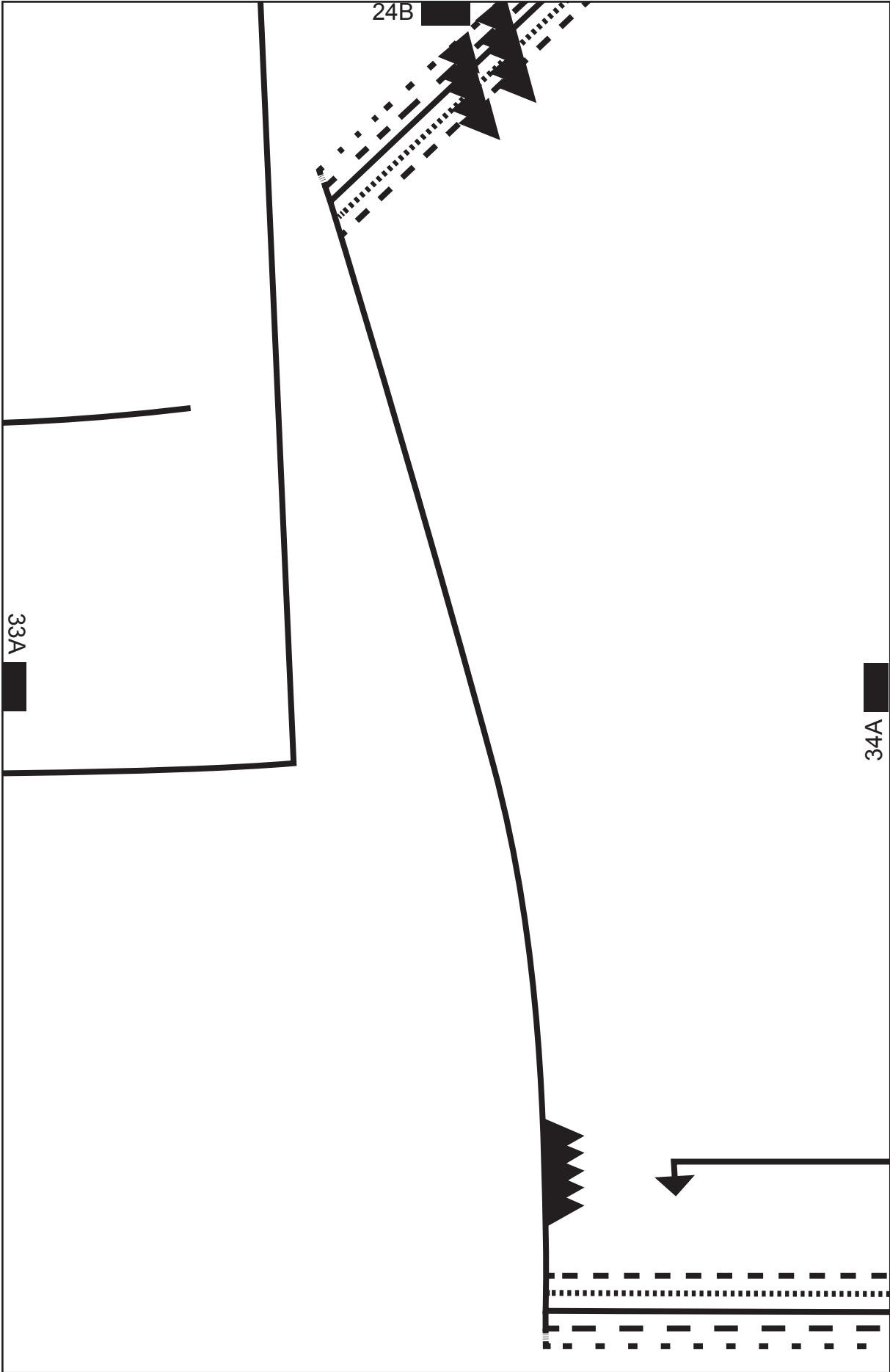

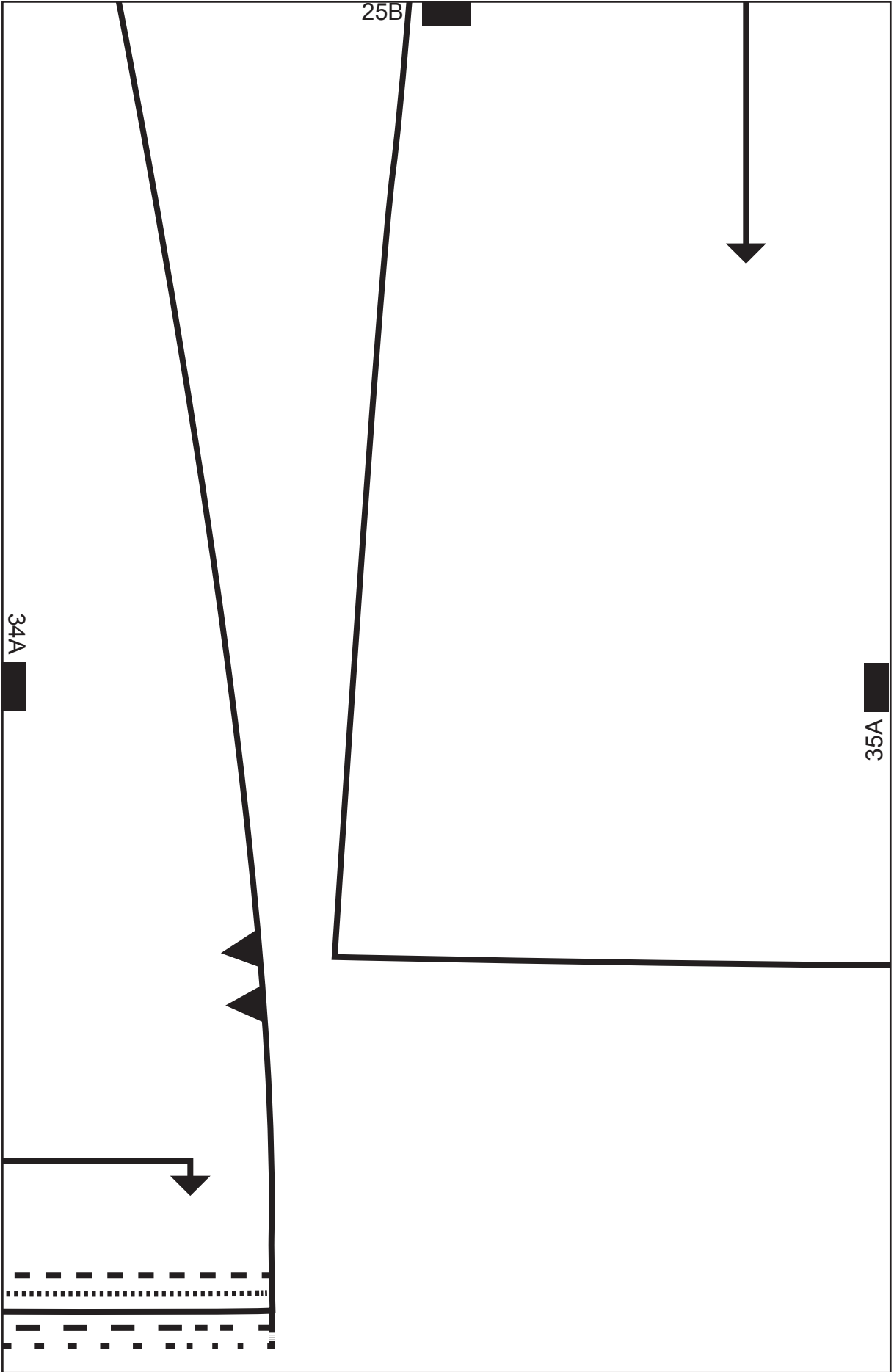

35A

26B

36A

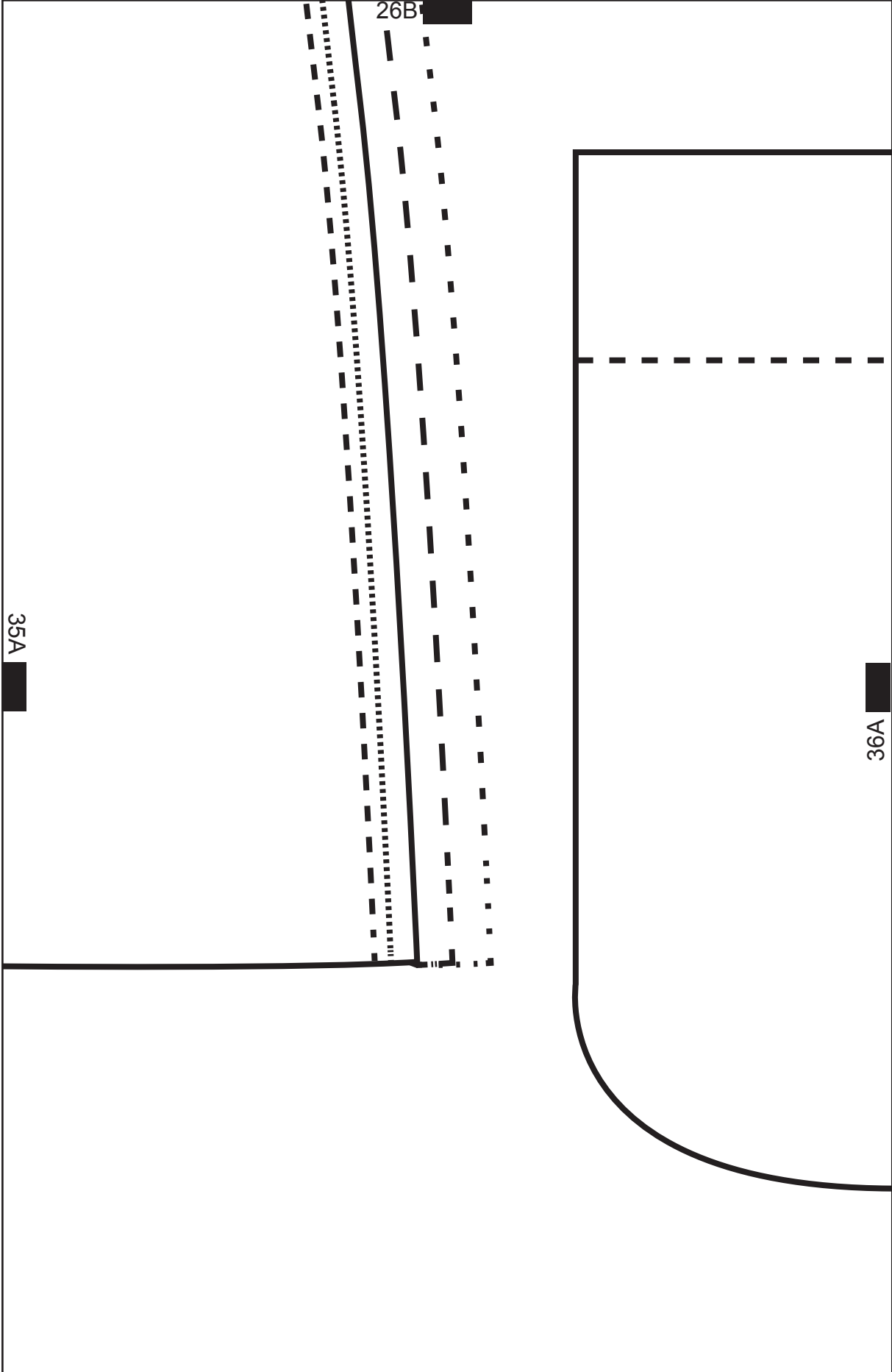

27B

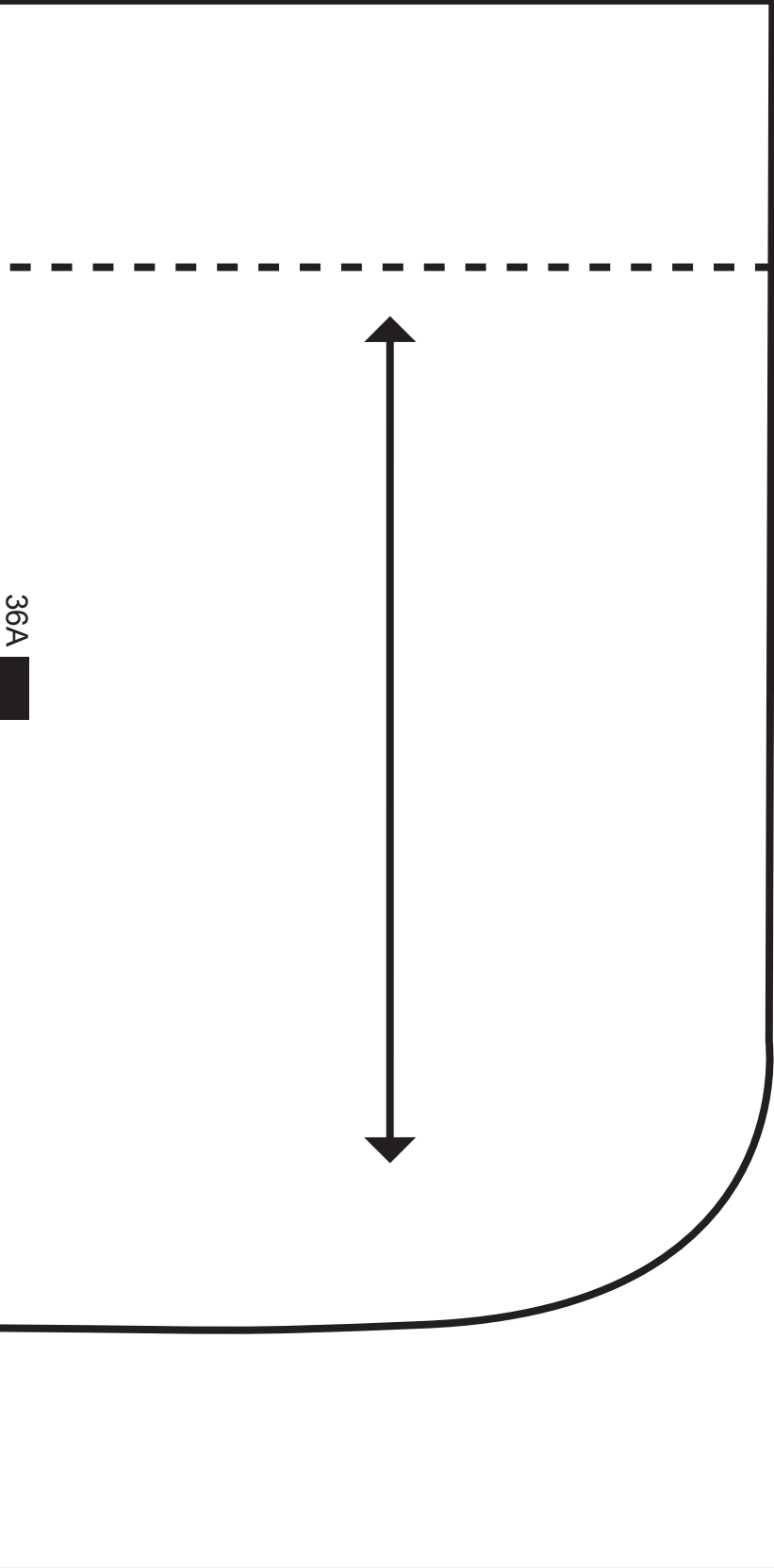

36A

37A

37A

28B

38A

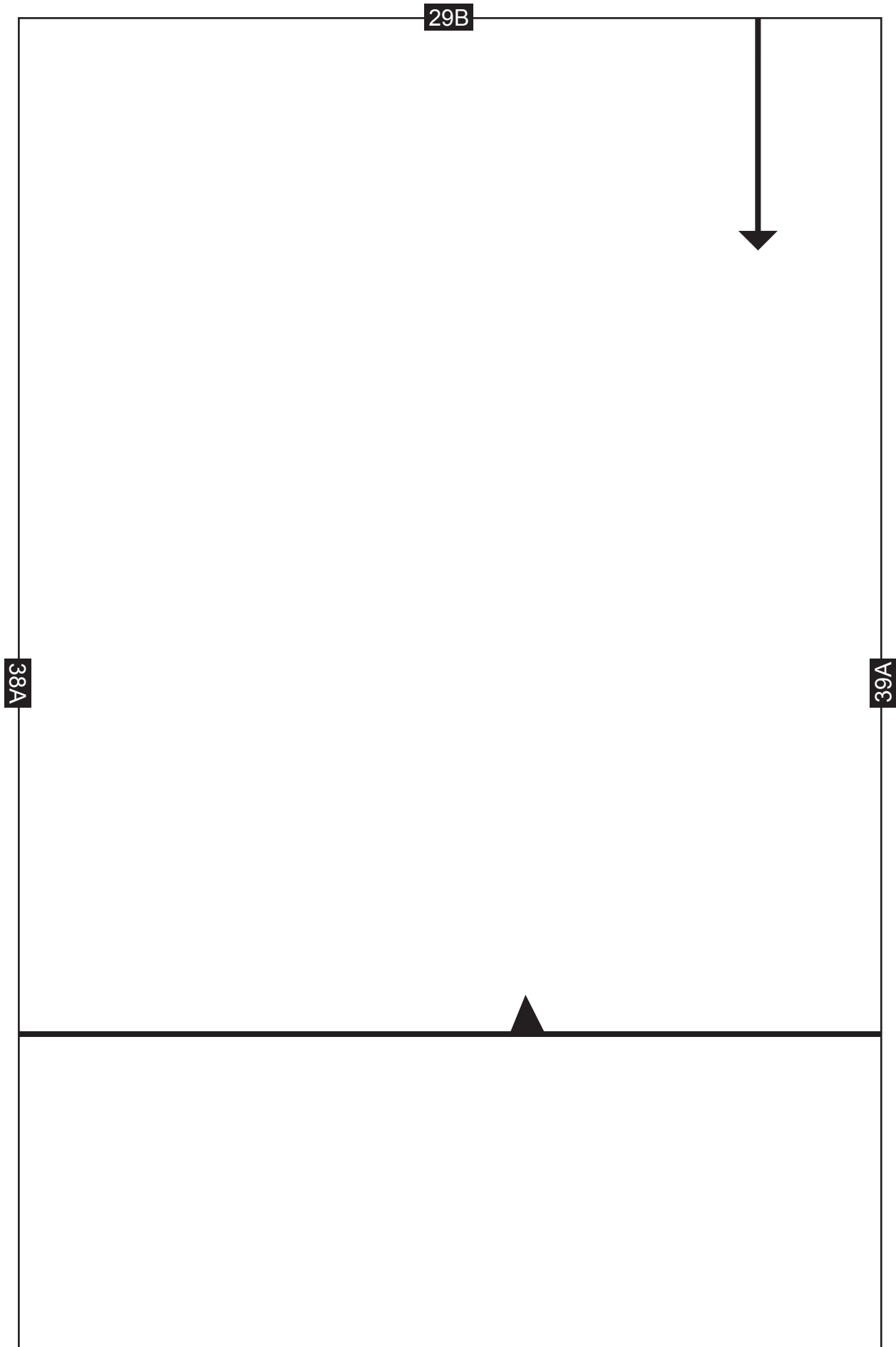

39A

30B

