

THE GREAT BRITISH *Sewing Bee*

Sweetest T-shirt pattern
Project design © Love Productions 2013
This design is protected by copyright
and must not be made for resale.

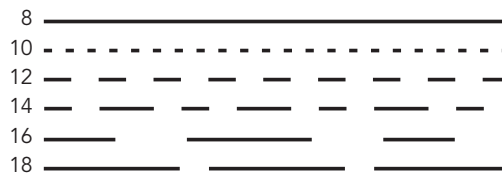

1A

1B

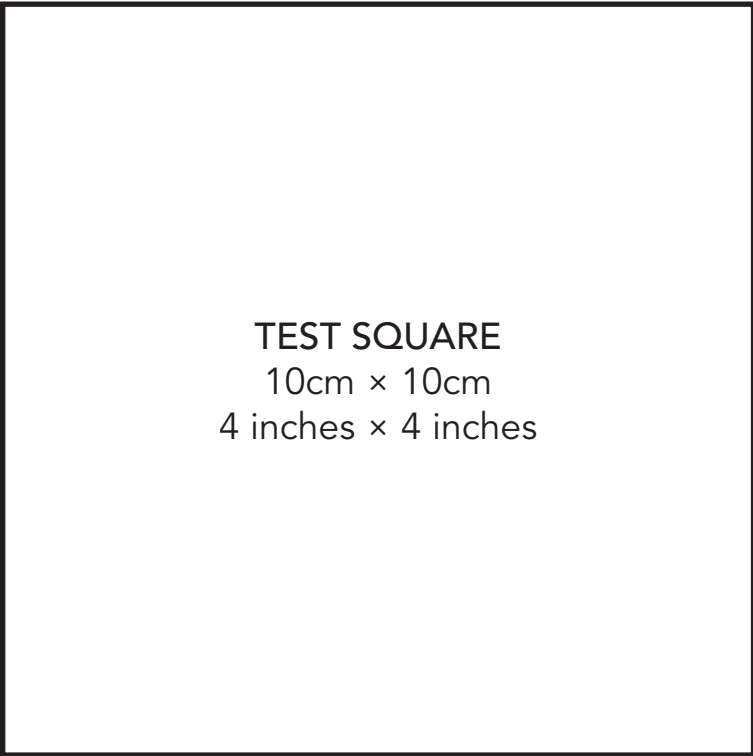

1A

2A

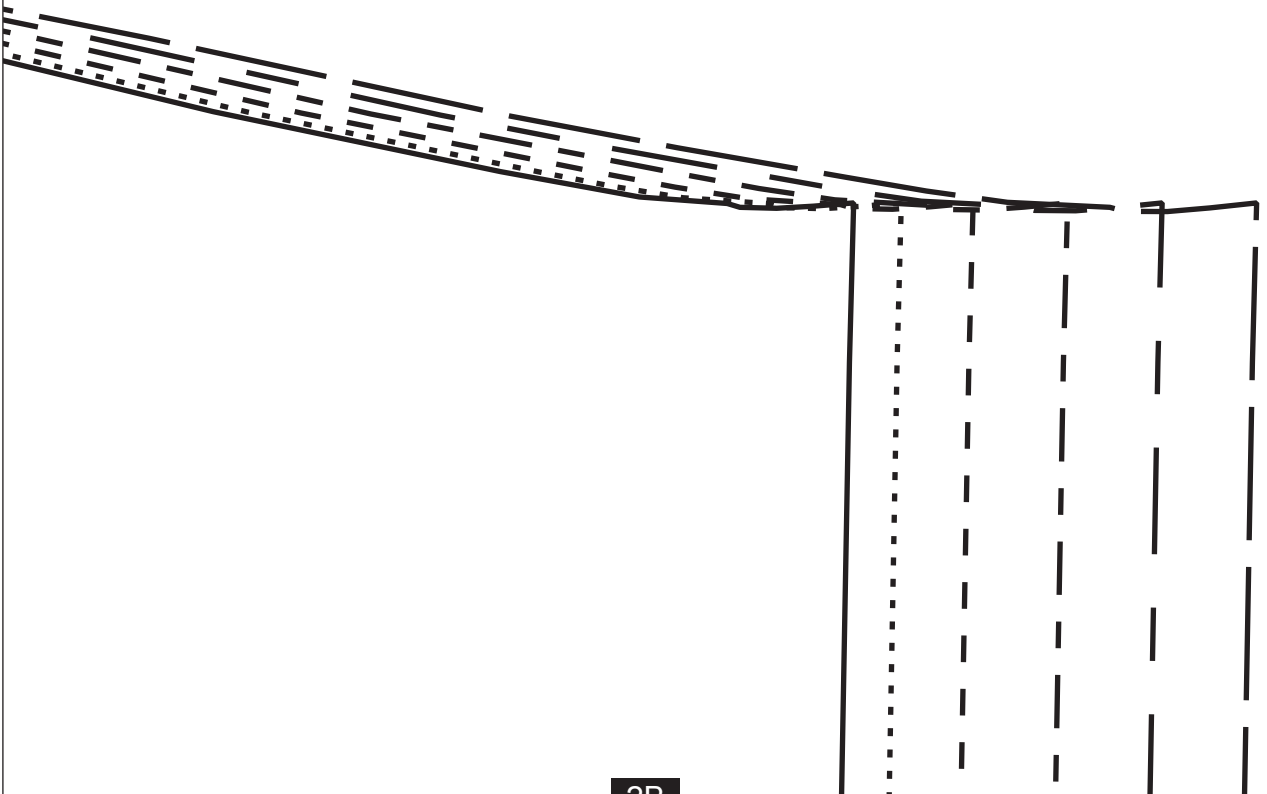

2B

2A

3A

3B

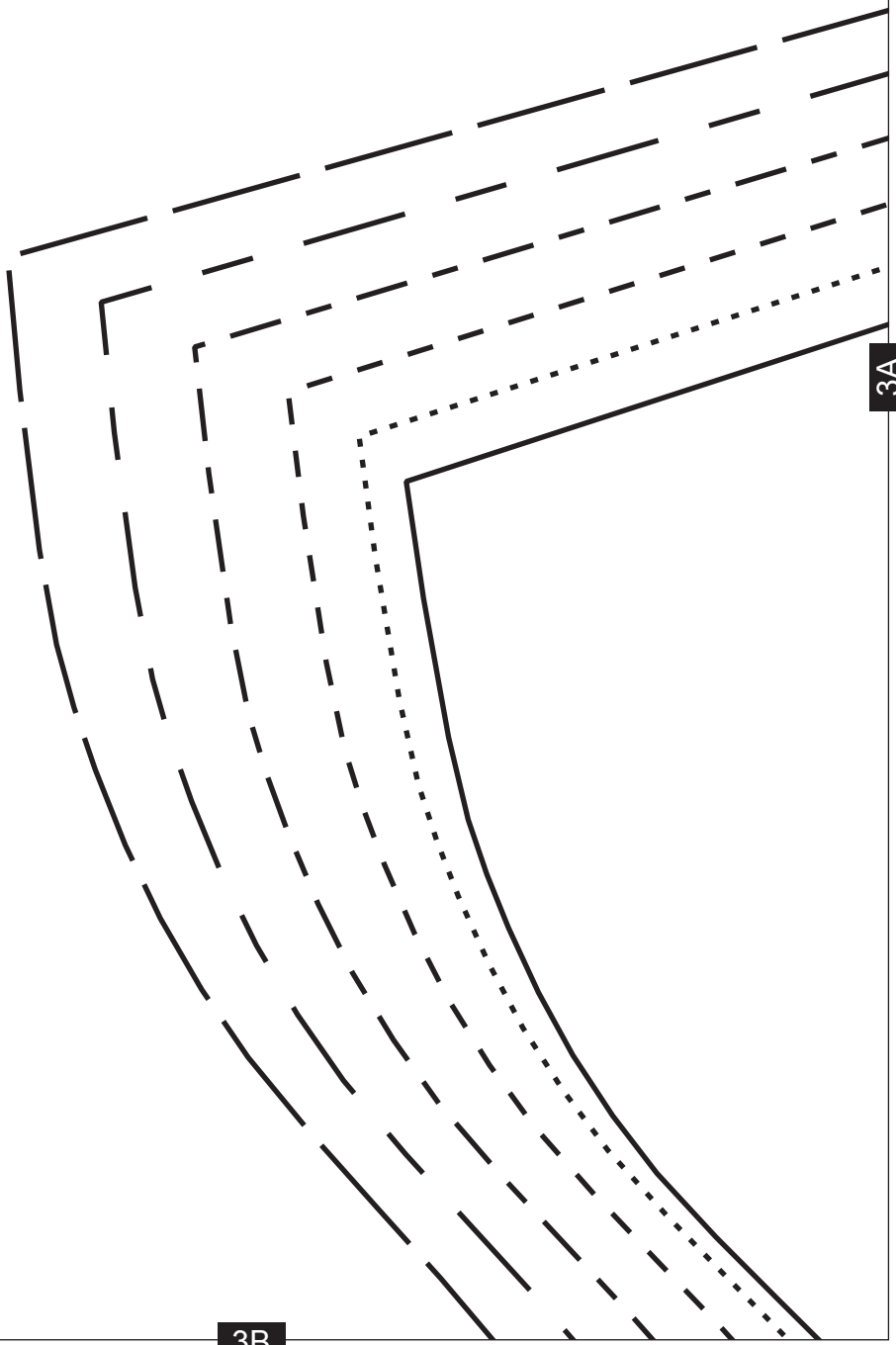

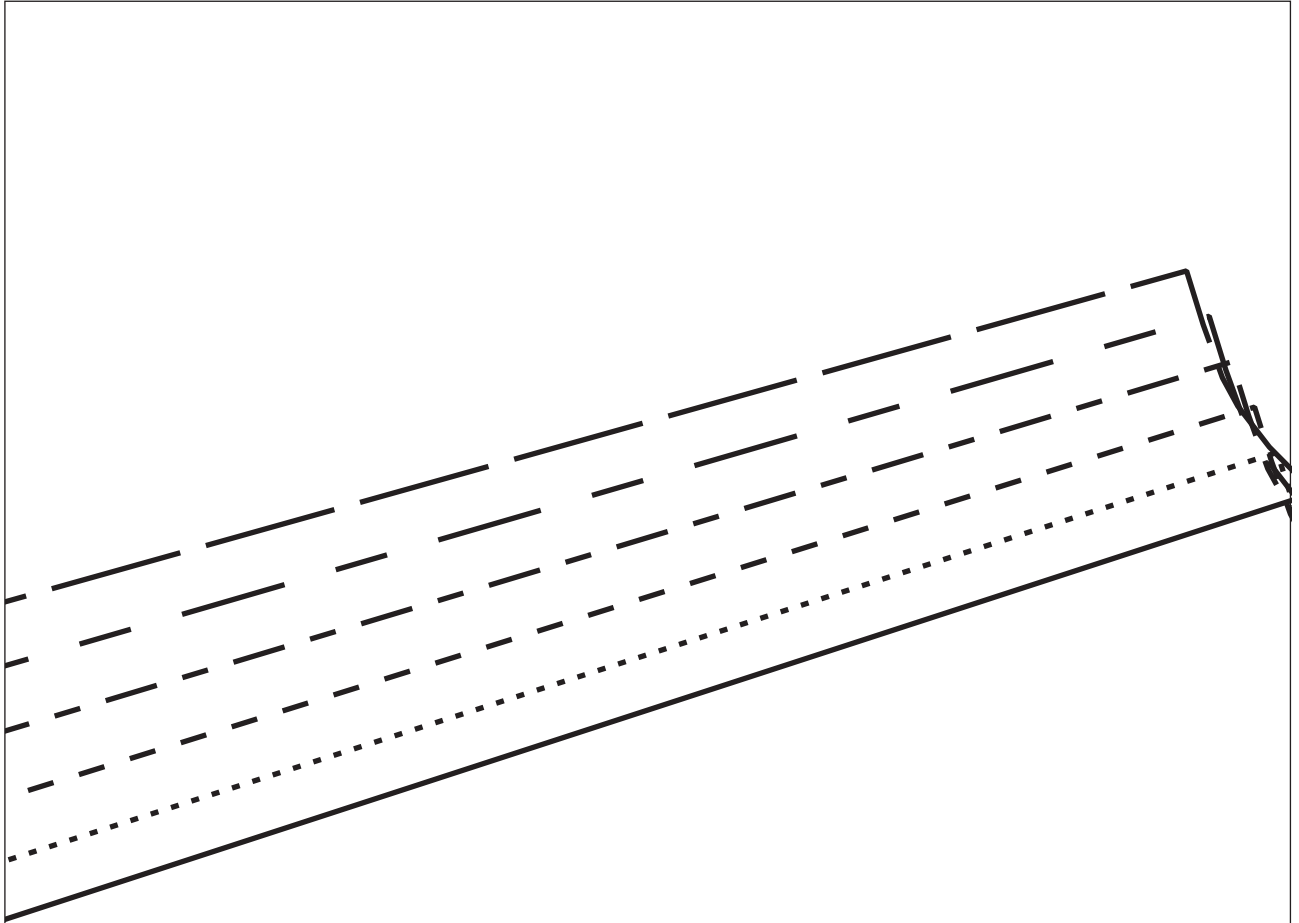

3A

4A

BACK

4B

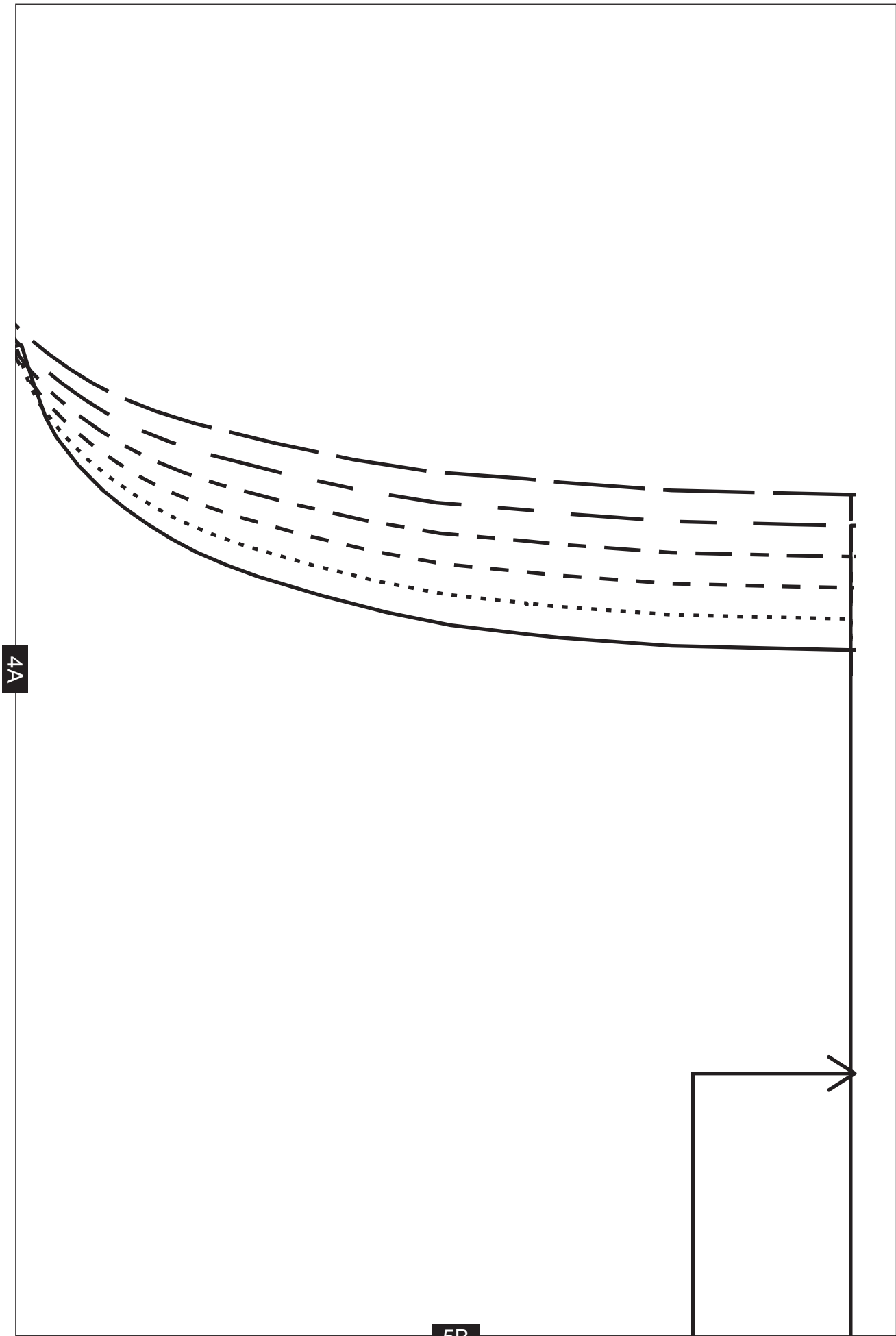

1B

LENGTHEN OR SHORTEN HERE



PLACE ON FOLD

6A

6B

2B

6A

7A

7B

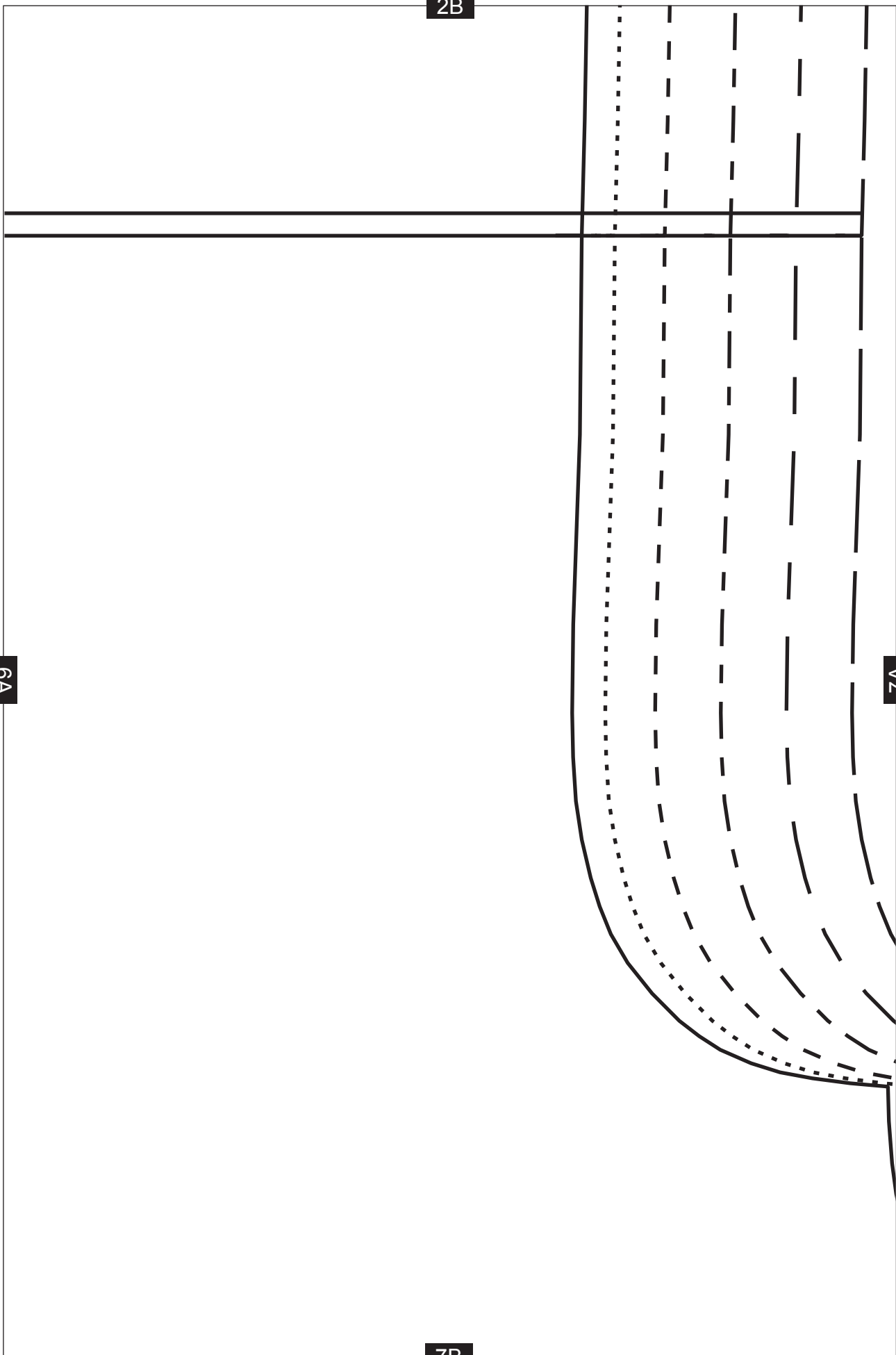

3B

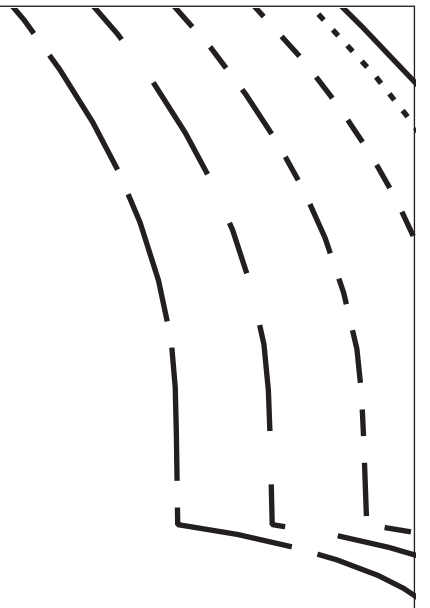

7A

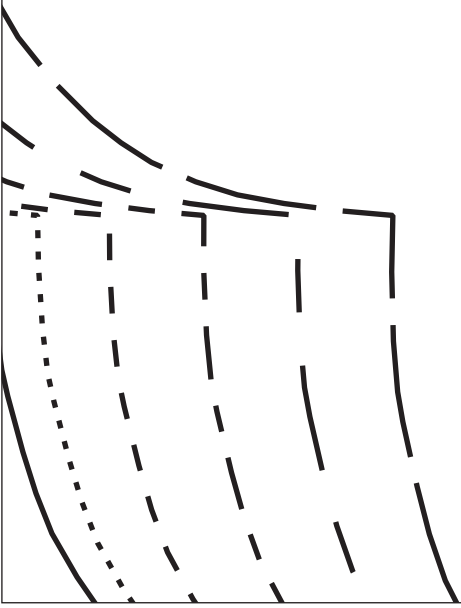

8A

8B

4B

8A

9A

9B

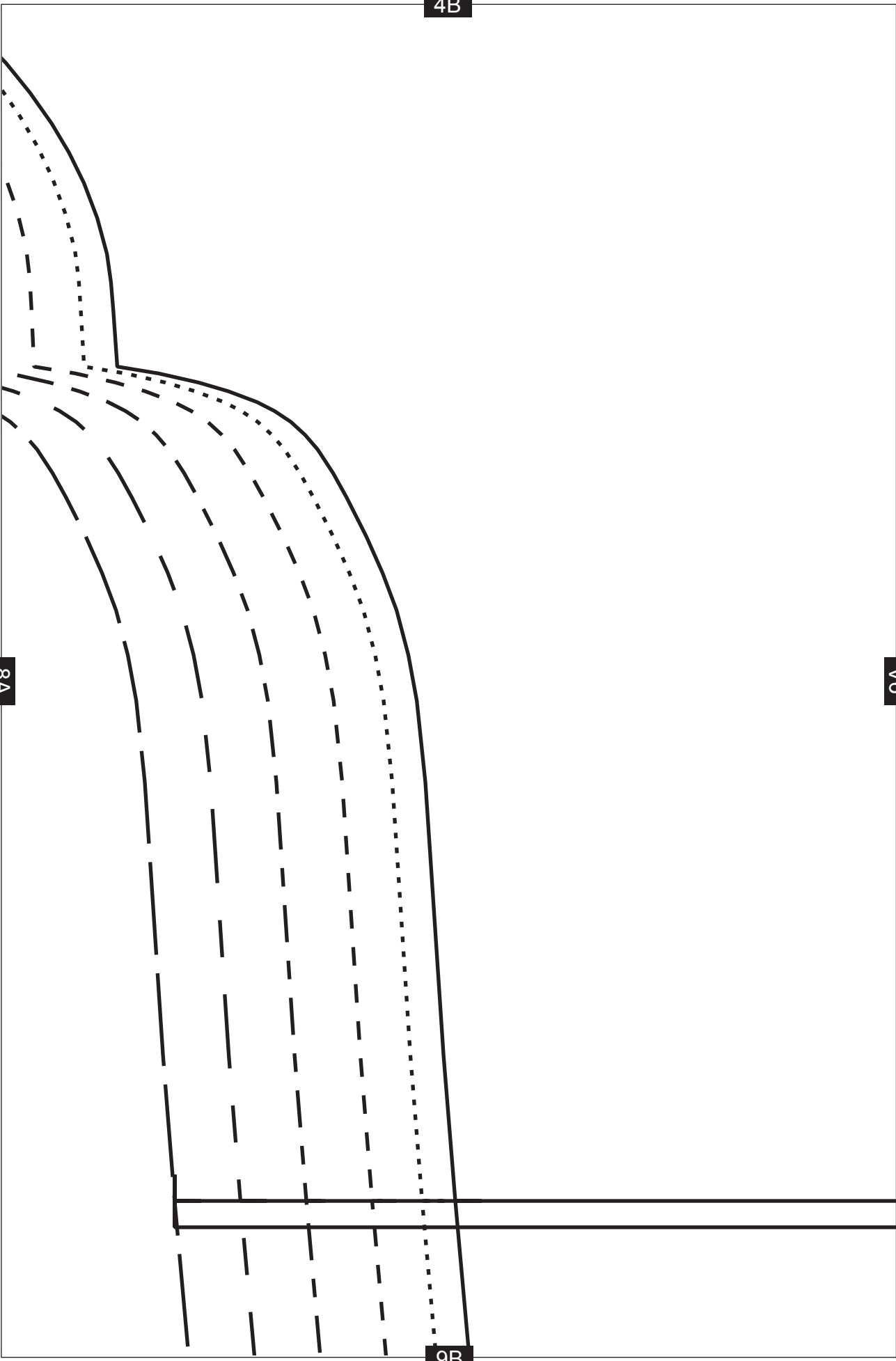

5B

9A

PLACE ON FOLD

LENGTHEN OR SHORTEN HERE



10B

6B

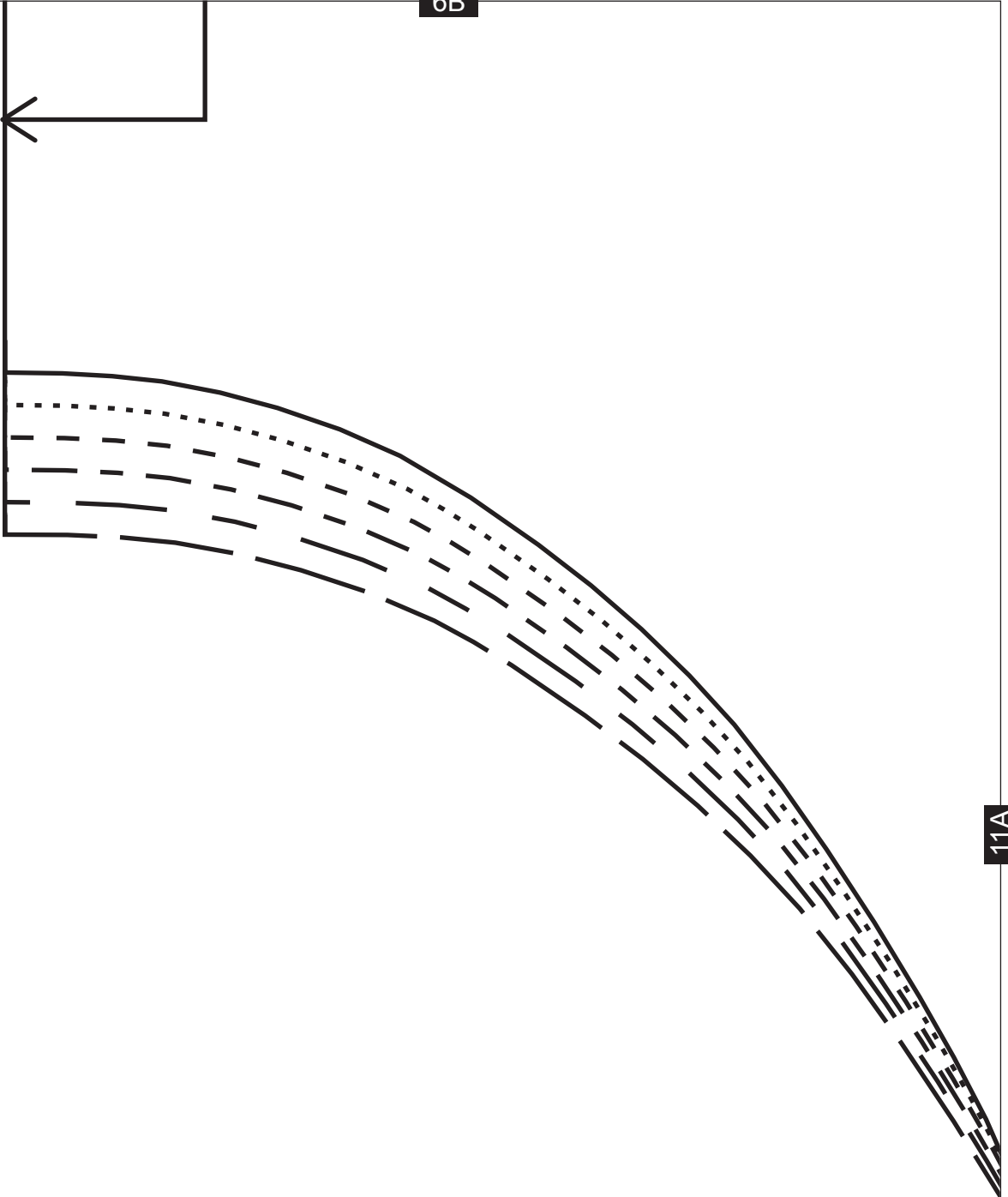

11A

7B

FRONT

11A

12A

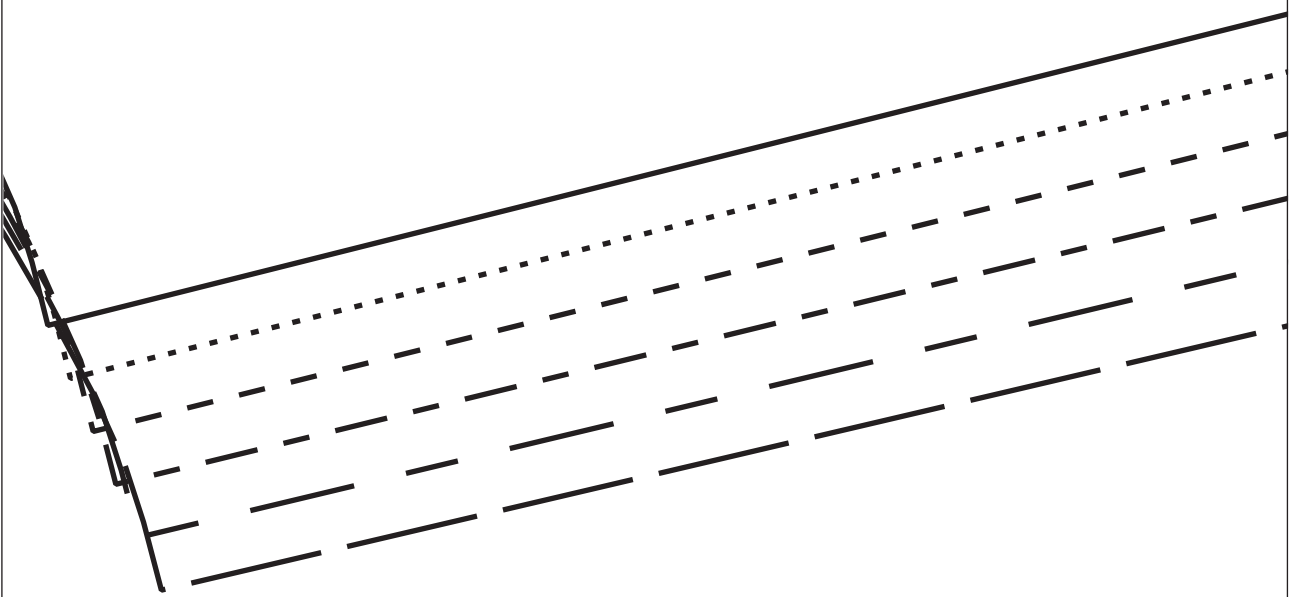

8B

12A

13A

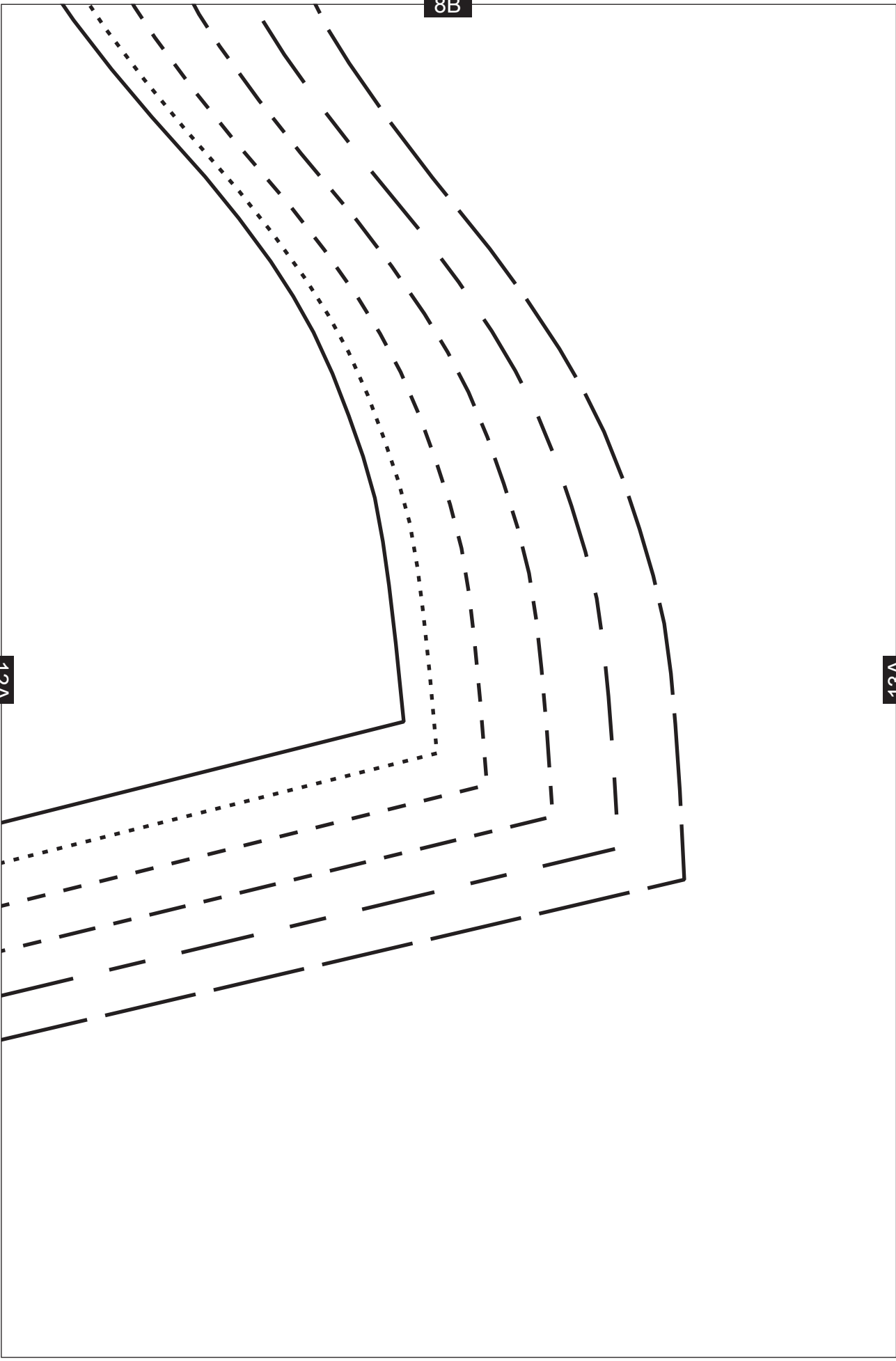

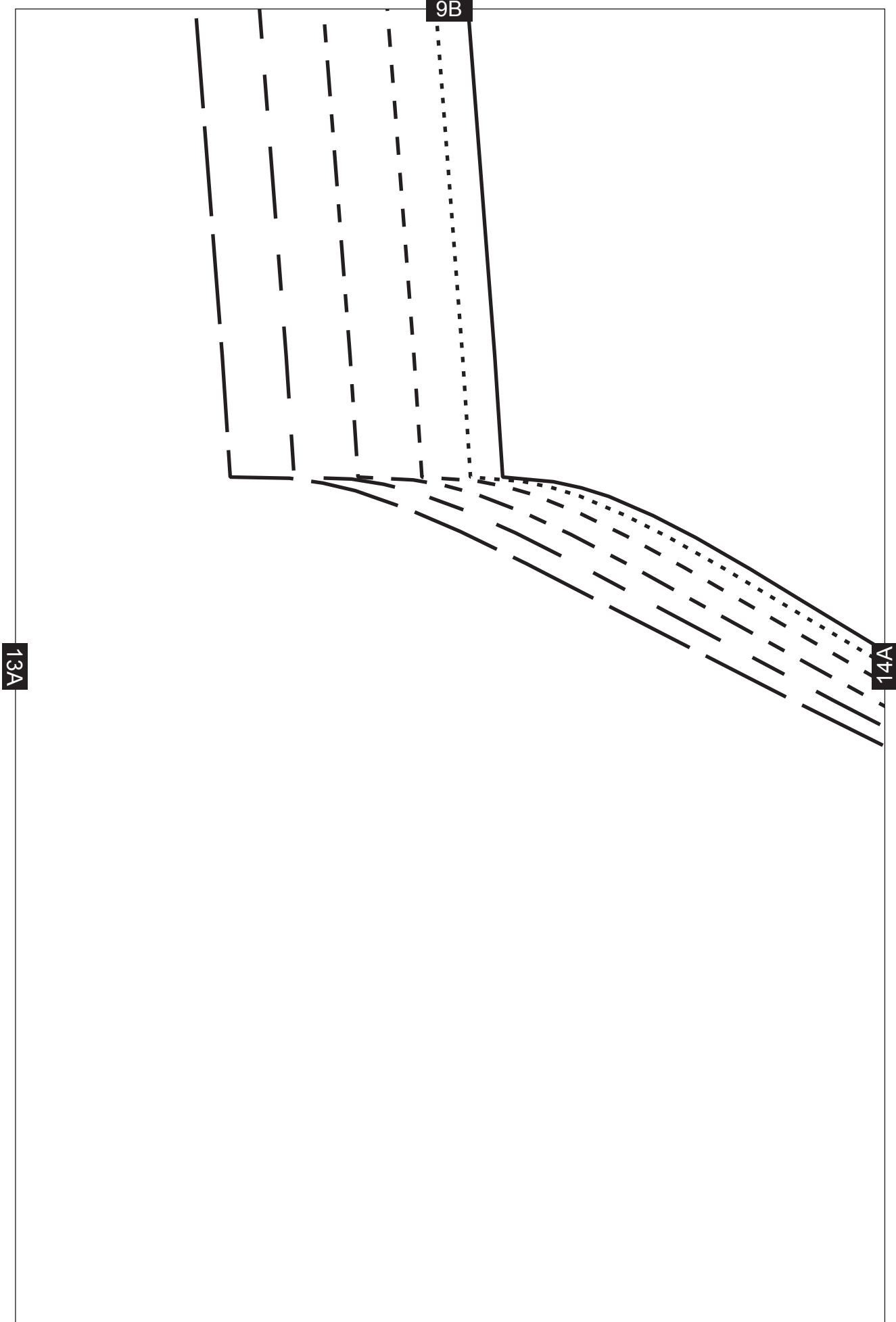

10B

14A

