

Corset Gown

Project design © Love Productions 2015
This design is protected by copyright and
must not be made for resale.

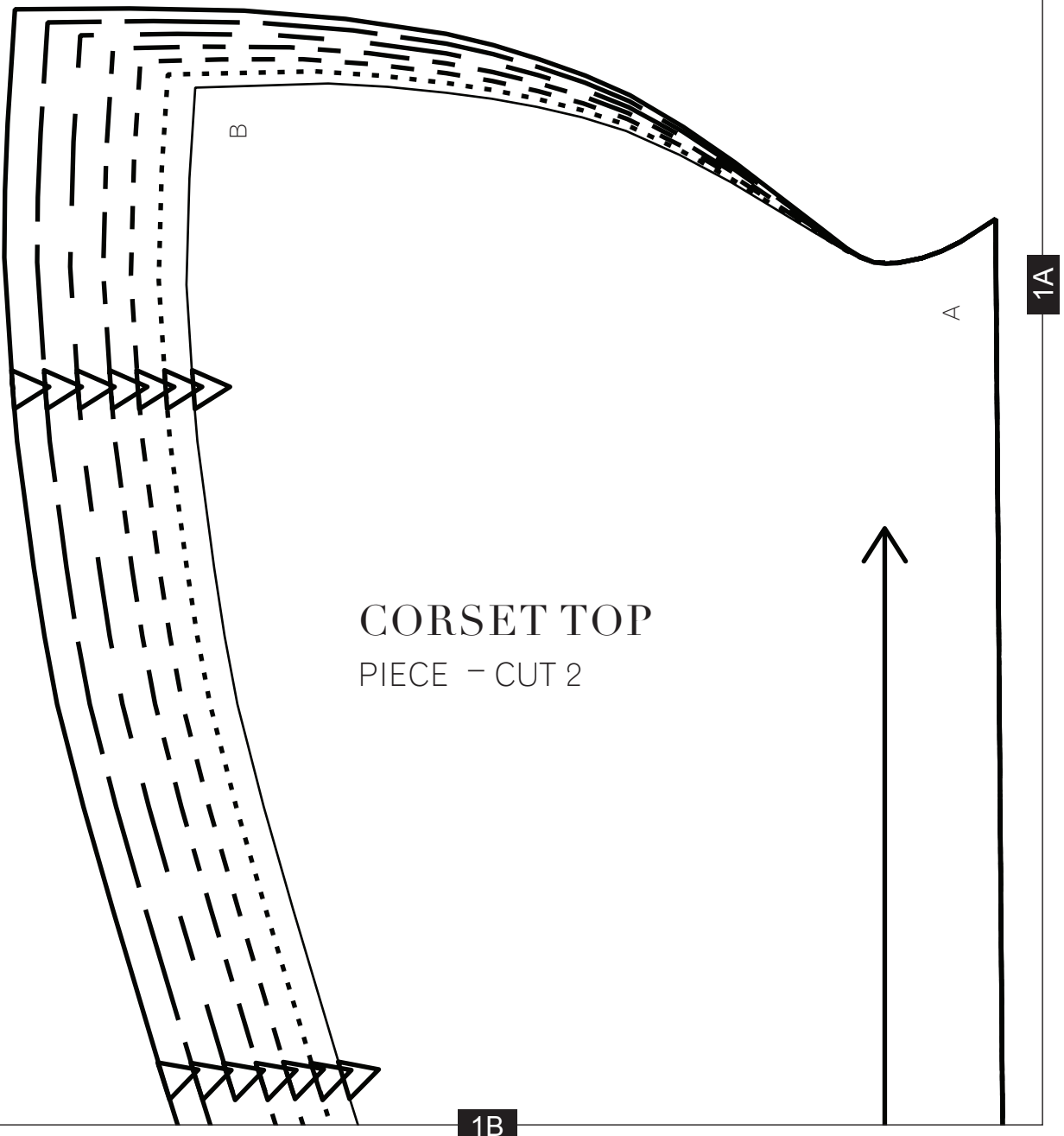

CORSET TOP
PIECE - CUT 2

1A

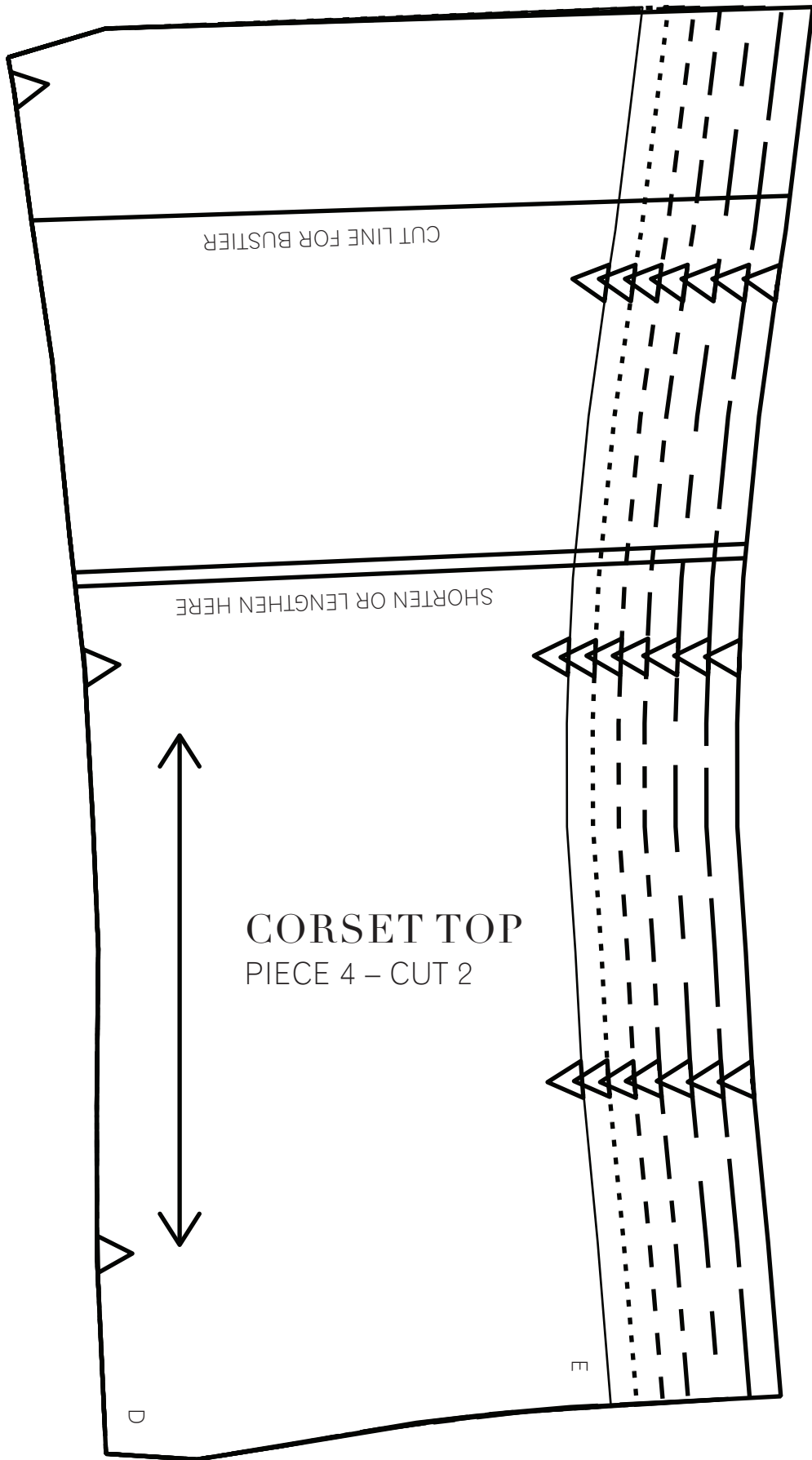

2A

2B

2A

3A

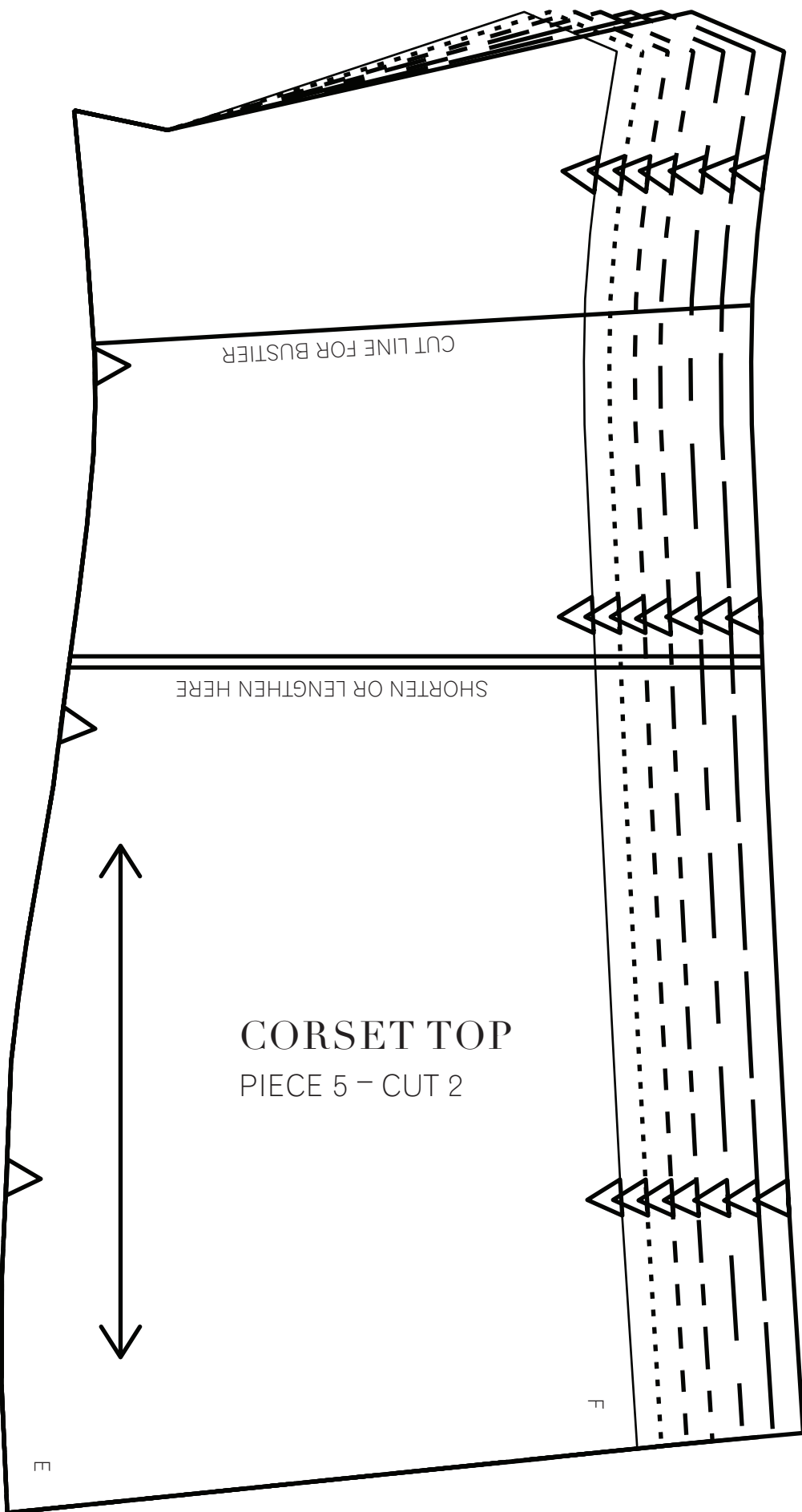

CORSET TOP
PIECE 5 - CUT 2

CUT LINE FOR BUSTIER

SHORTEN OR LENGTHEN HERE

3B

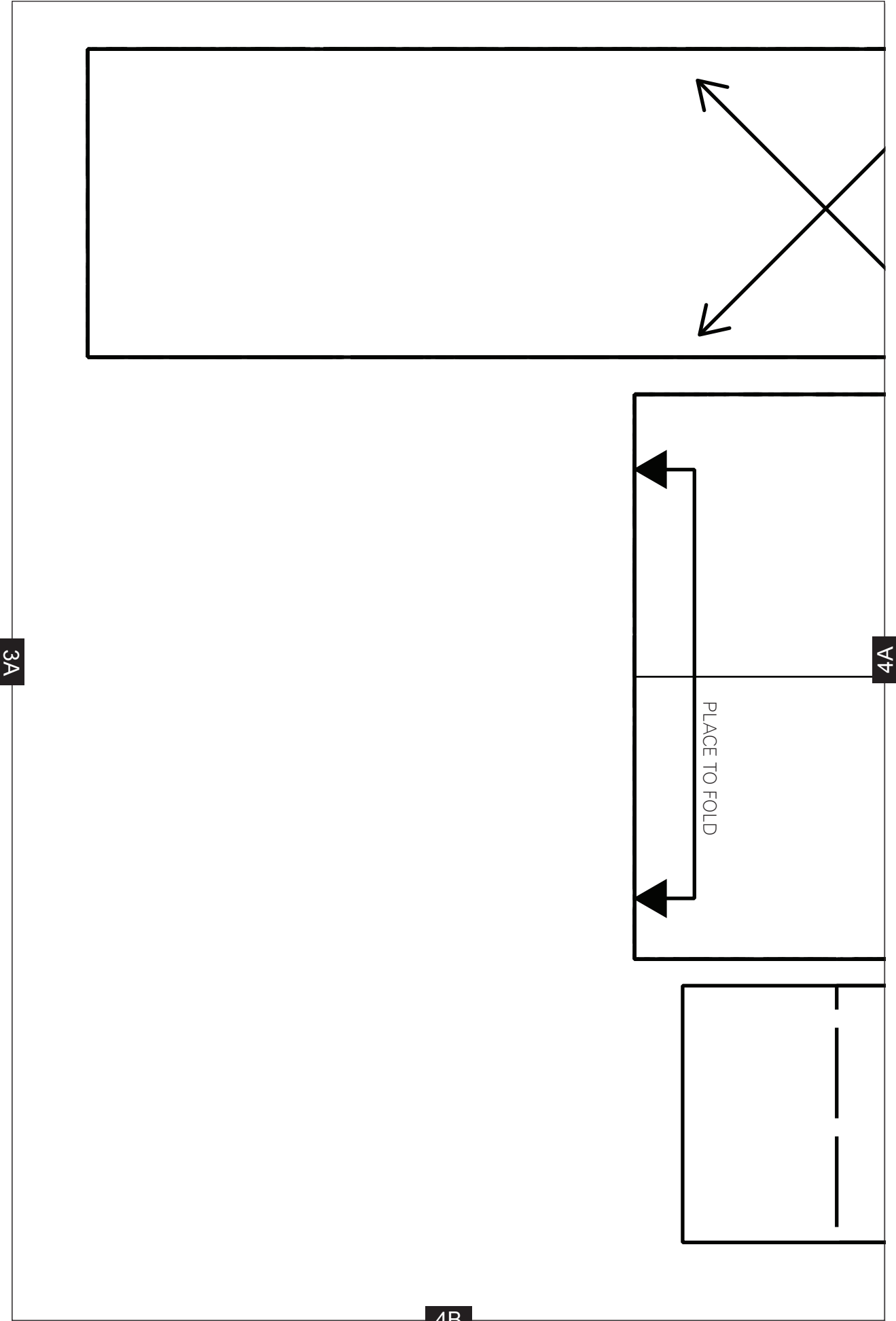

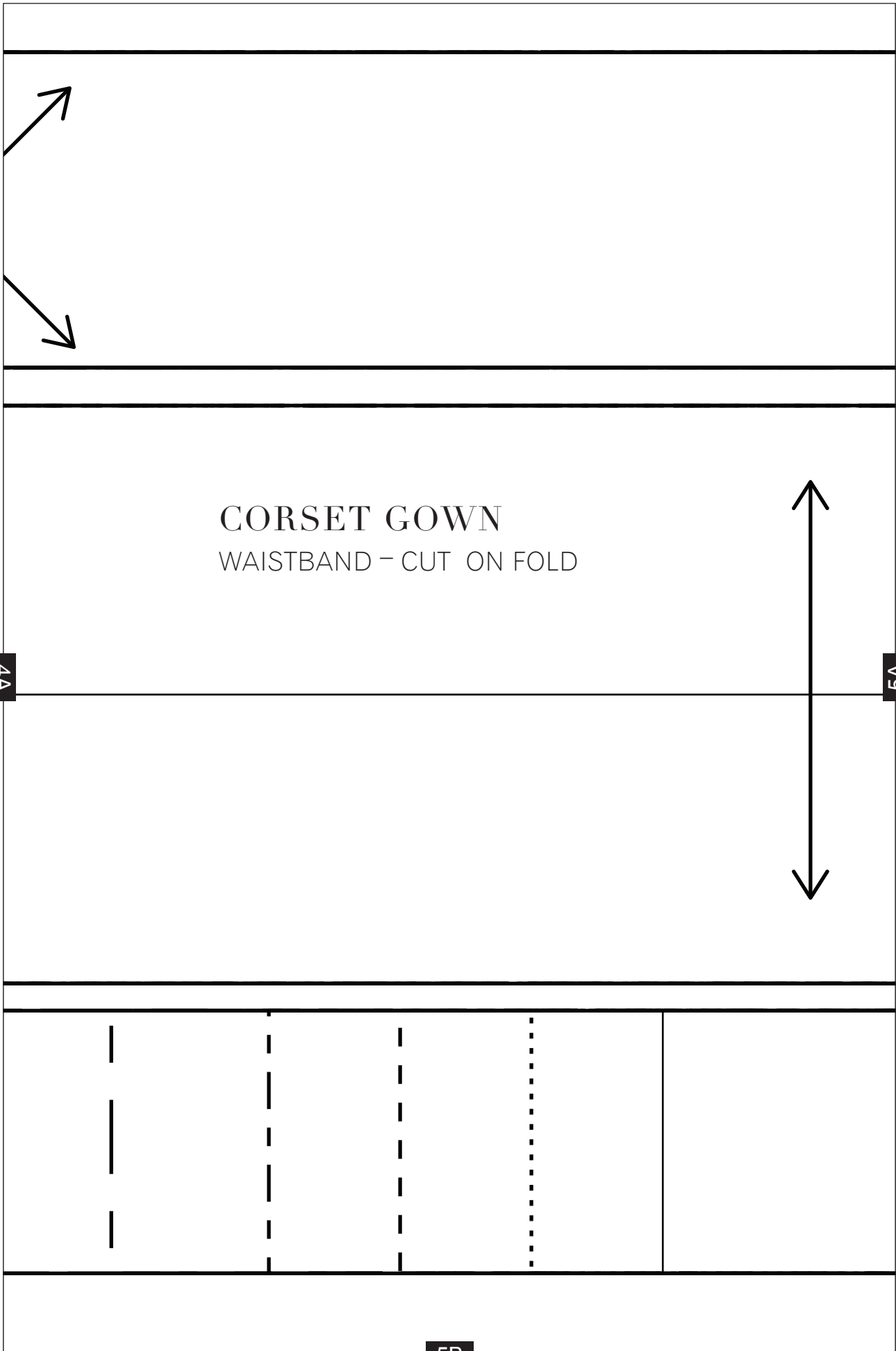

CORSET GOWN
WAISTBAND - CUT ON FOLD



4A

5A

5B

CORSET TOP

BIAS STRIP –
CUT 2 ON THE BIAS

5A

FOLDLINE

INCLUDES EXTRA 1.5-CM ($\frac{5}{8}$ -IN)
OVERLAP FOR BUTTONS

6A

SEAM ALLOWANCE INCLUDED



6B

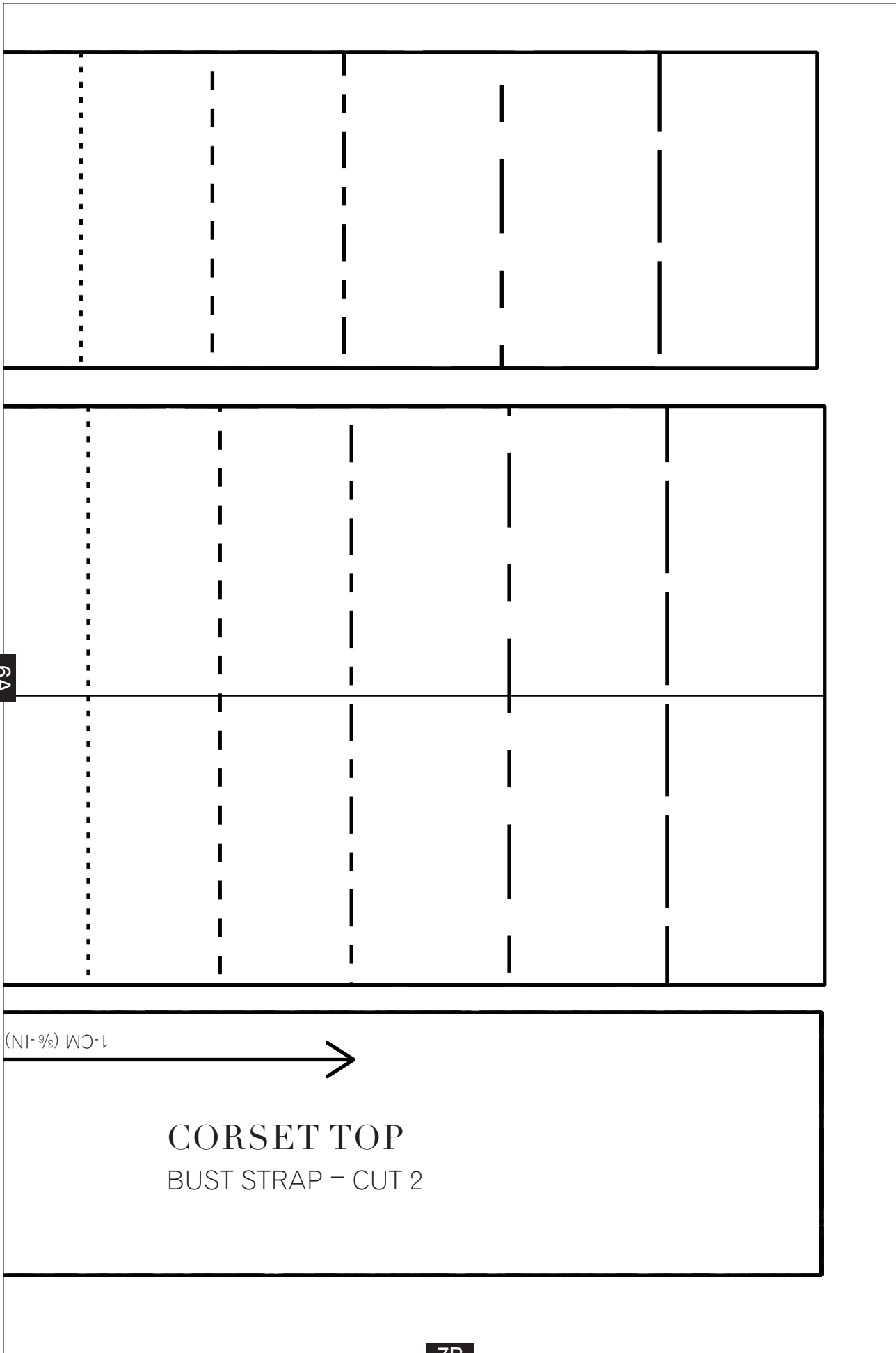

6A

(NI-9/16) WC-1

CORSET TOP
BUST STRAP - CUT 2

7B

1B



SHORTEN OR LENGTHEN HERE

CUT LINE FOR BUSTIER

8A

8B

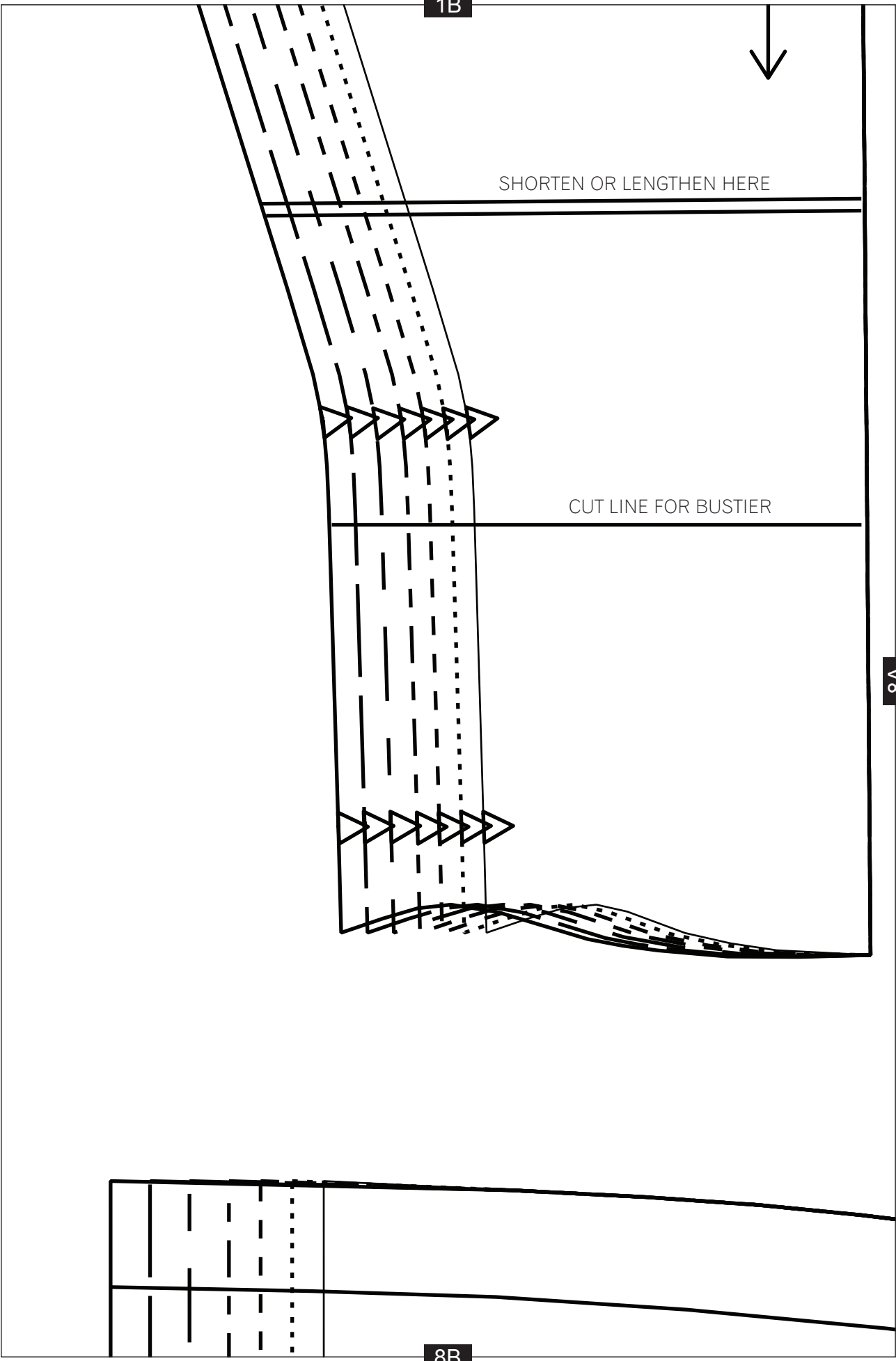

2B

8A

9A

CUT LINE FOR BUSTIER

SHORTEN OR LENGTHEN HERE

9B

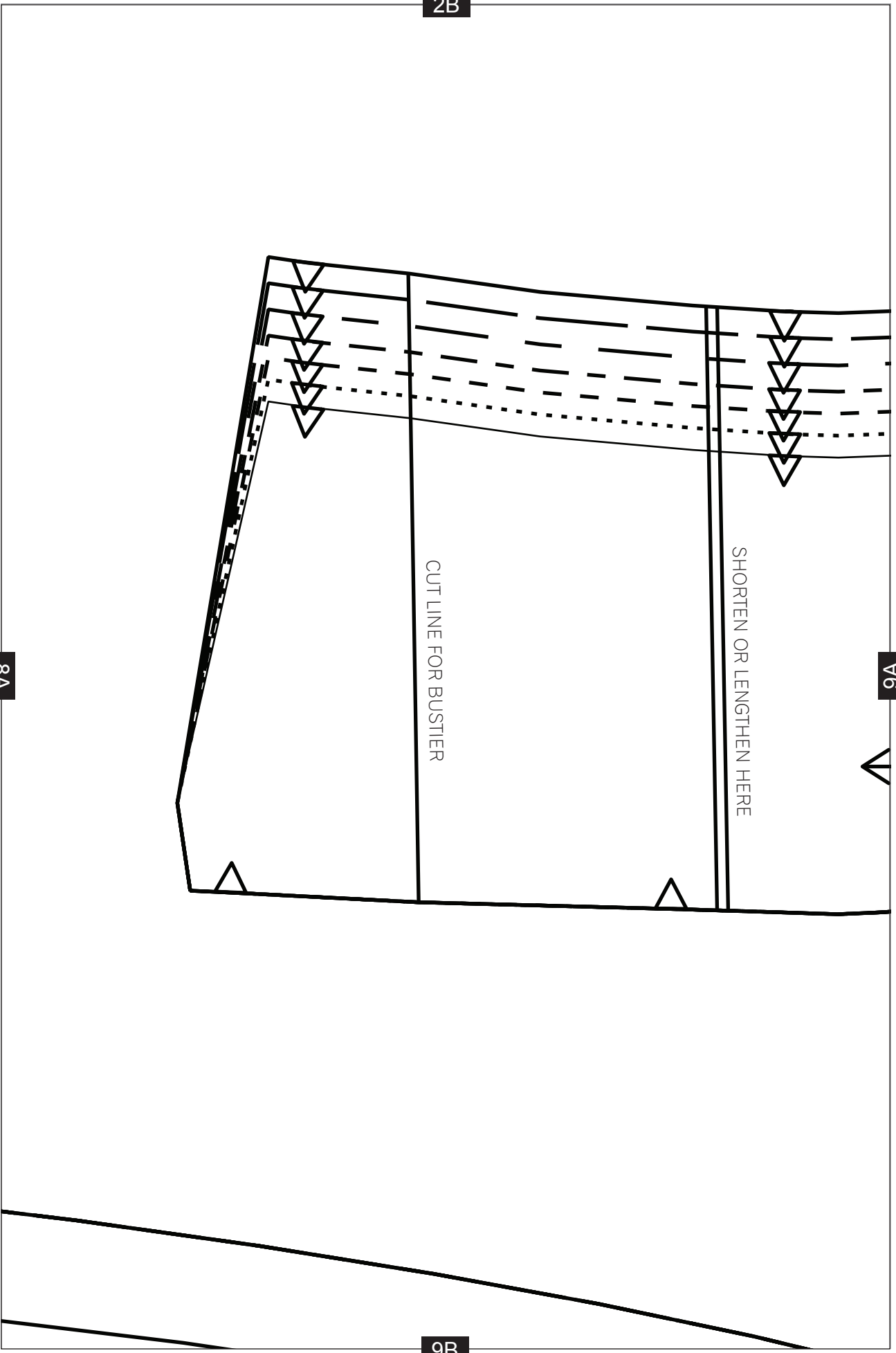

3B

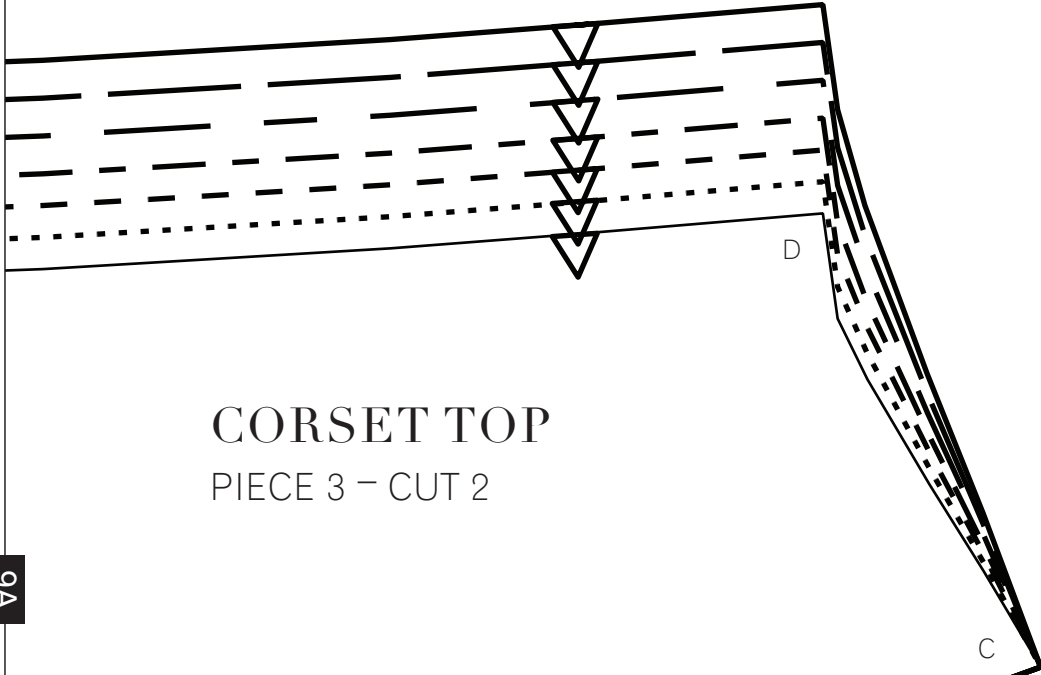

CORSET TOP
PIECE 3 - CUT 2

9A

10A

10B

4B

10A

11A

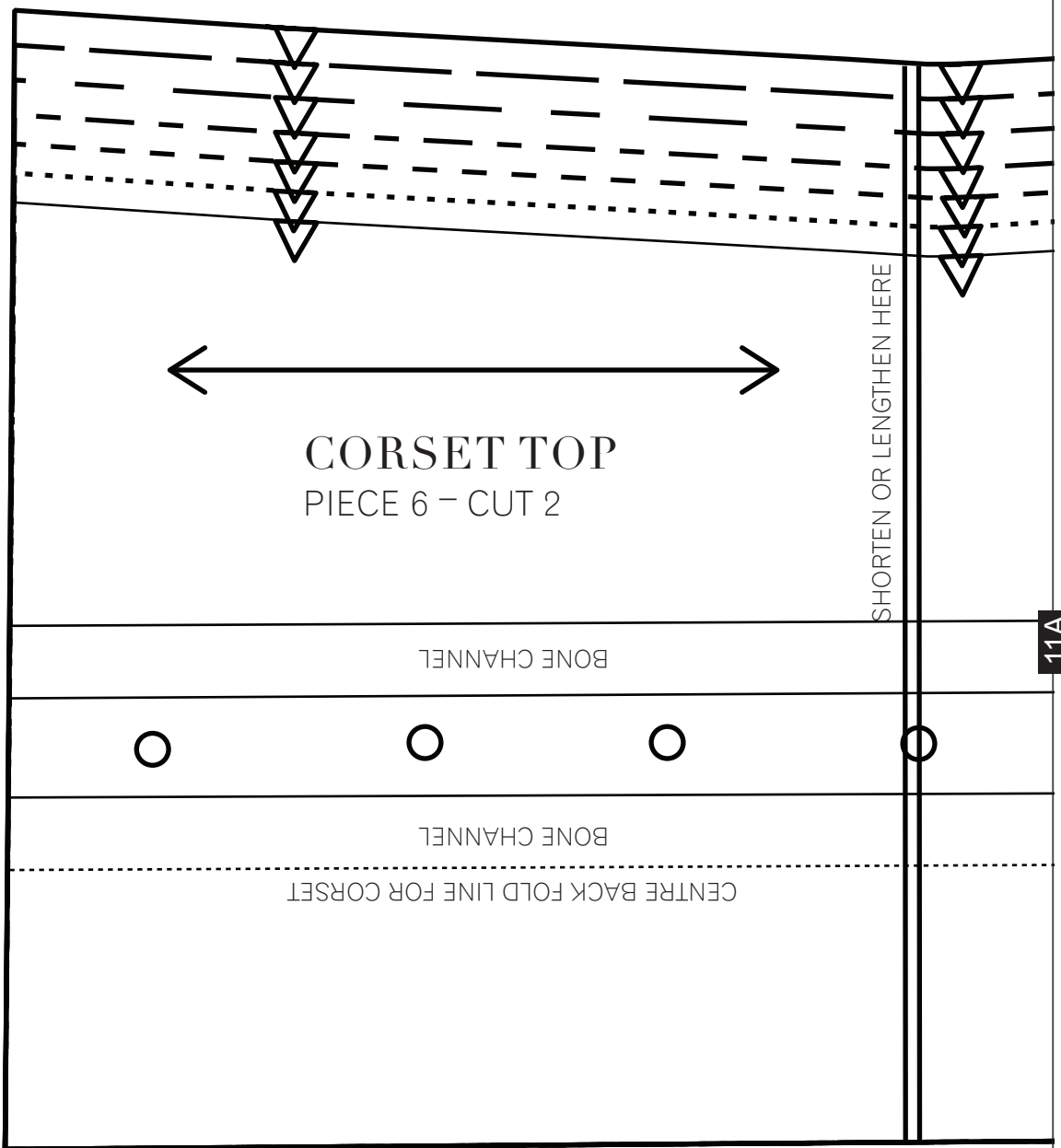

CORSET TOP
PIECE 6 - CUT 2

SHORTEN OR LENGTHEN HERE

BONE CHANNEL

BONE CHANNEL

CENTRE BACK FOLD LINE FOR CORSET

11B

5B

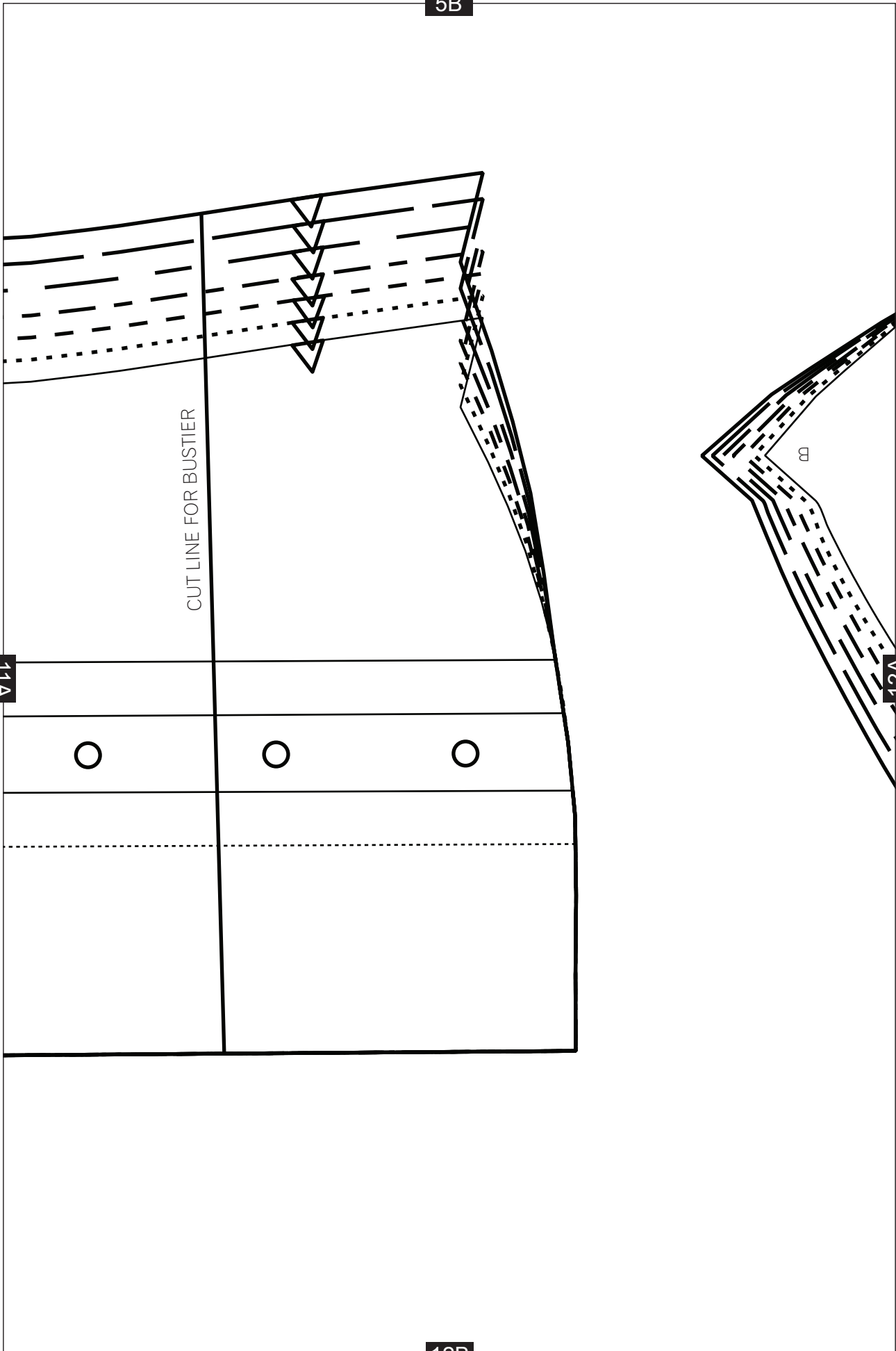

11A

12A

12B

6B

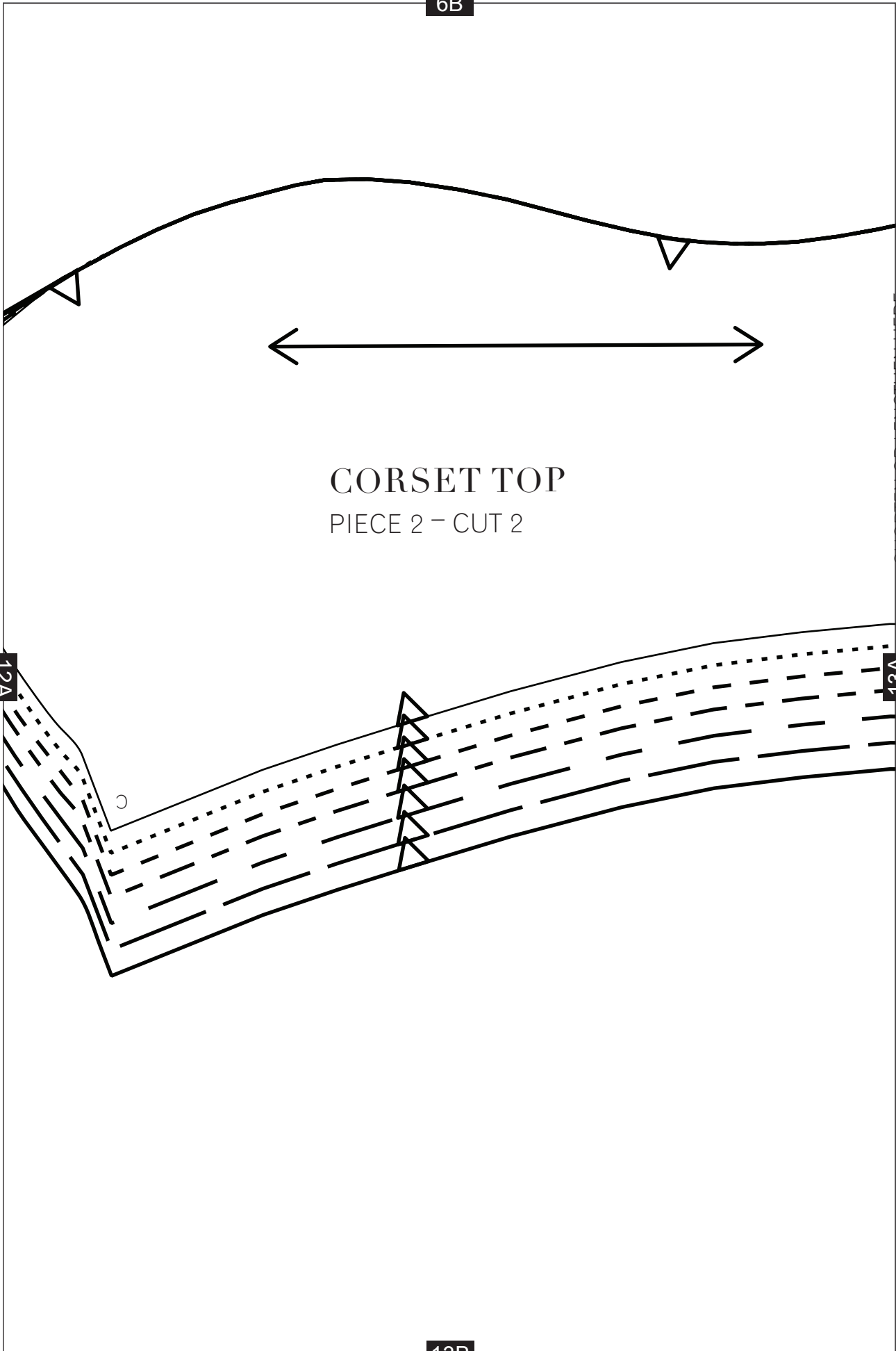

12A

13A

13B

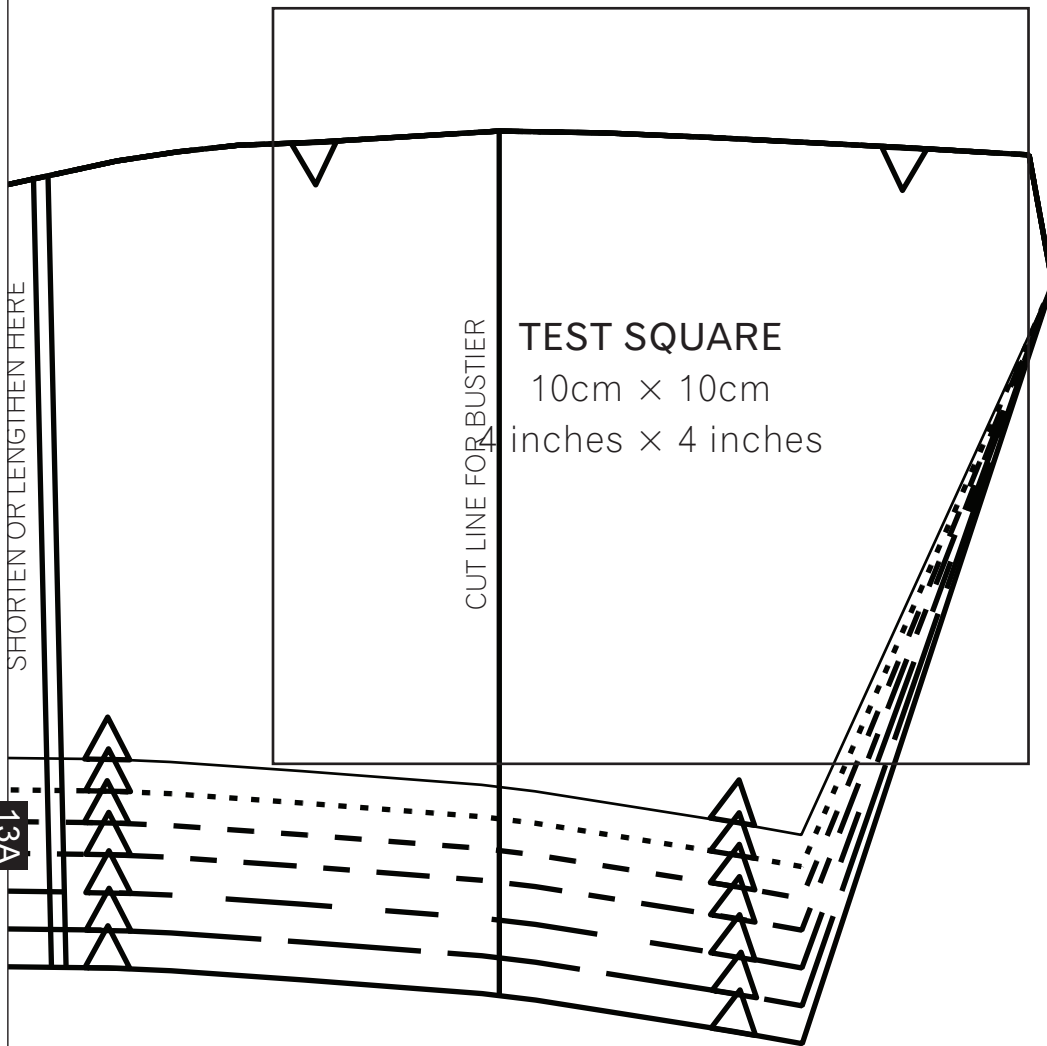

8B

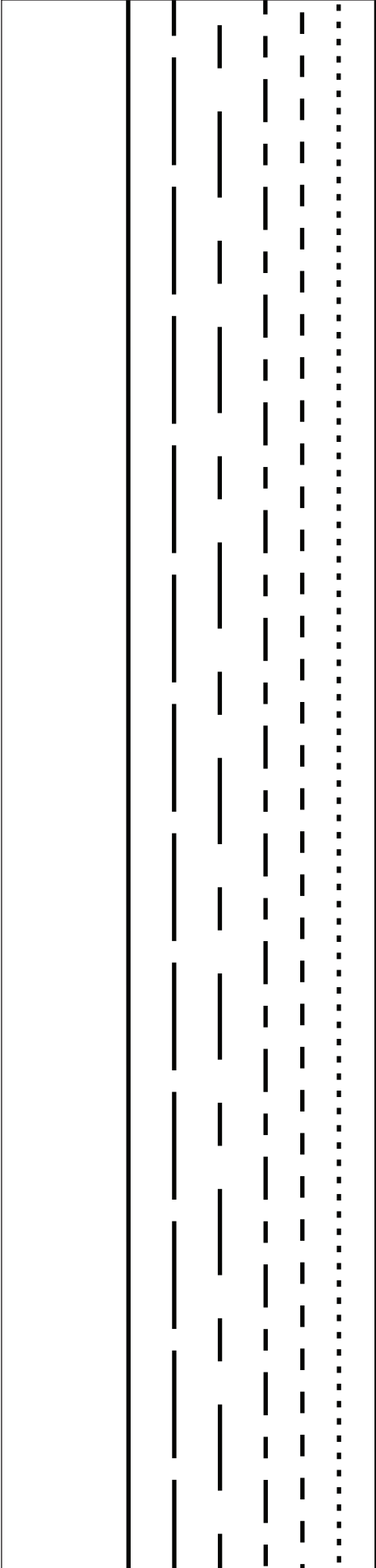

15B

15A

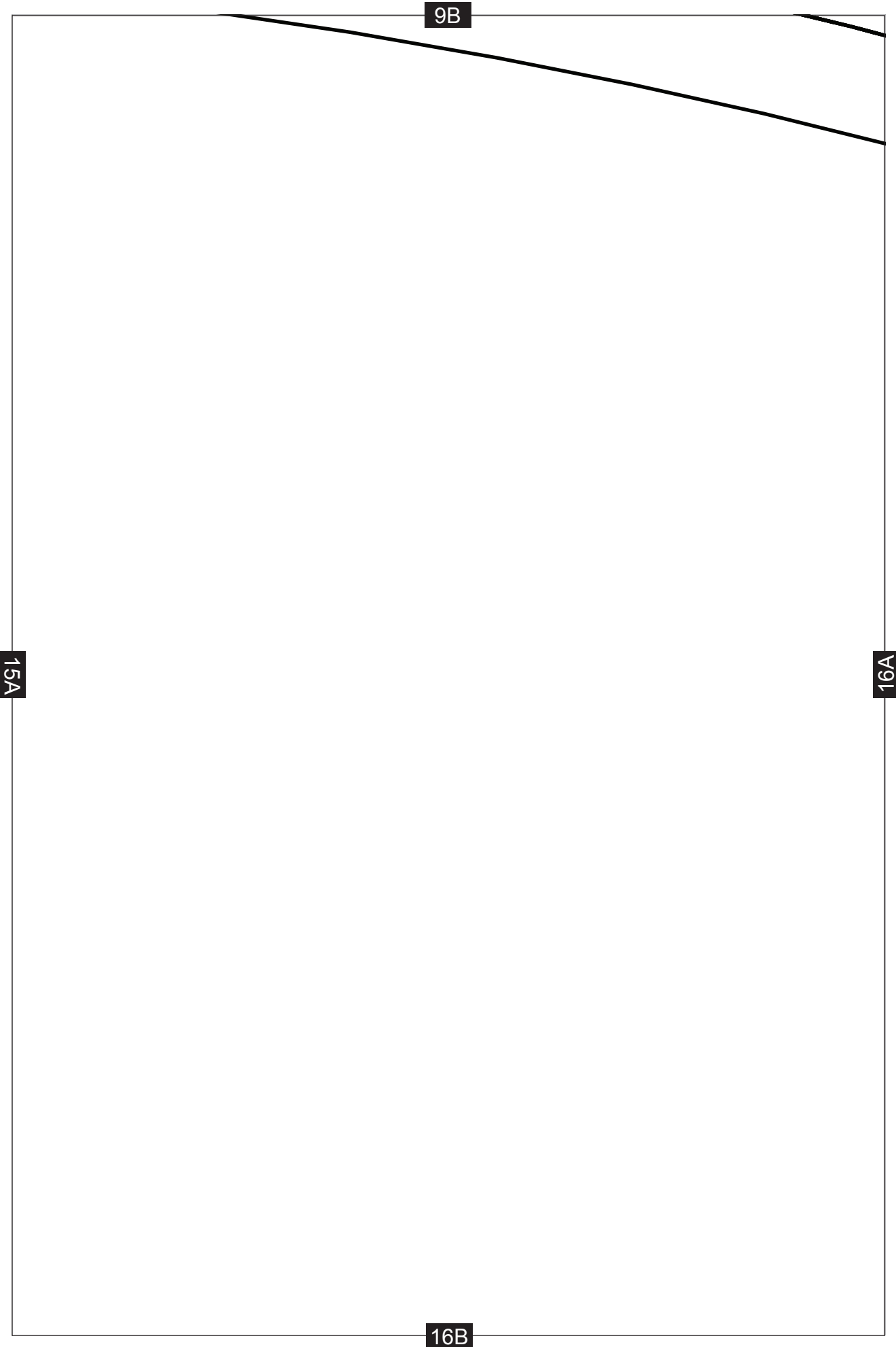

10B

16A

17A

17B

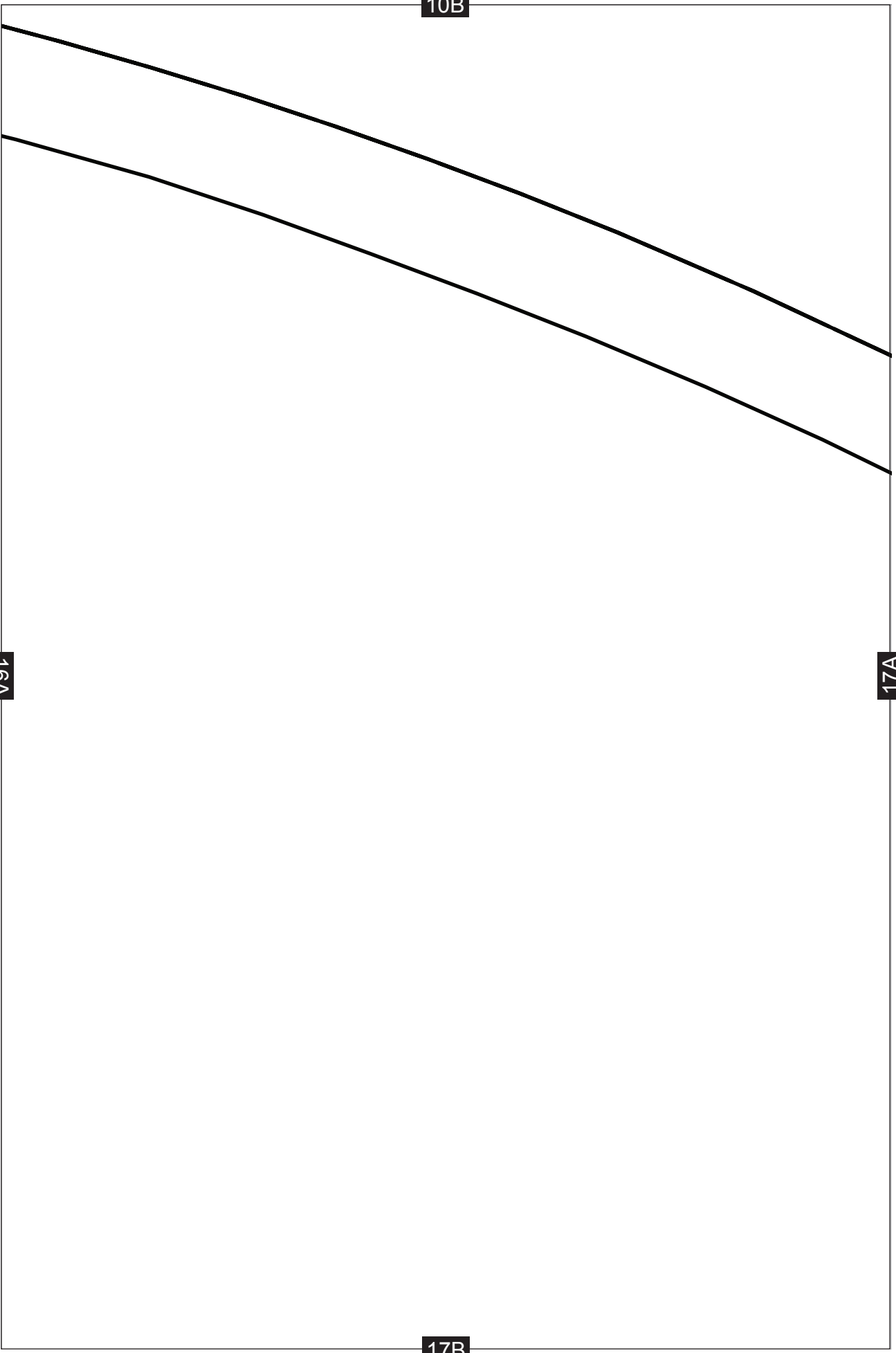

11B

18A

17A

18B

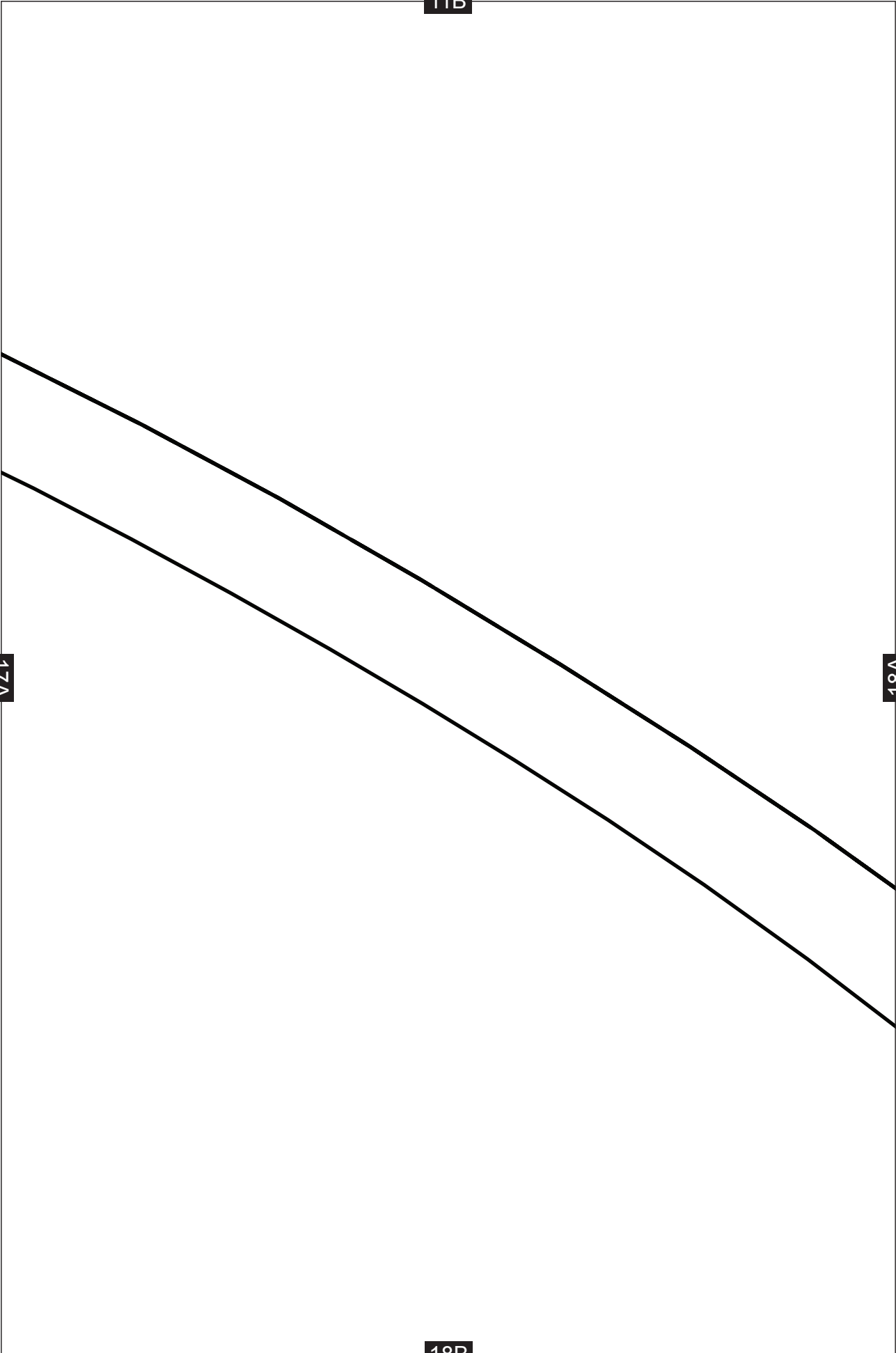

12B

18A

19A

19B

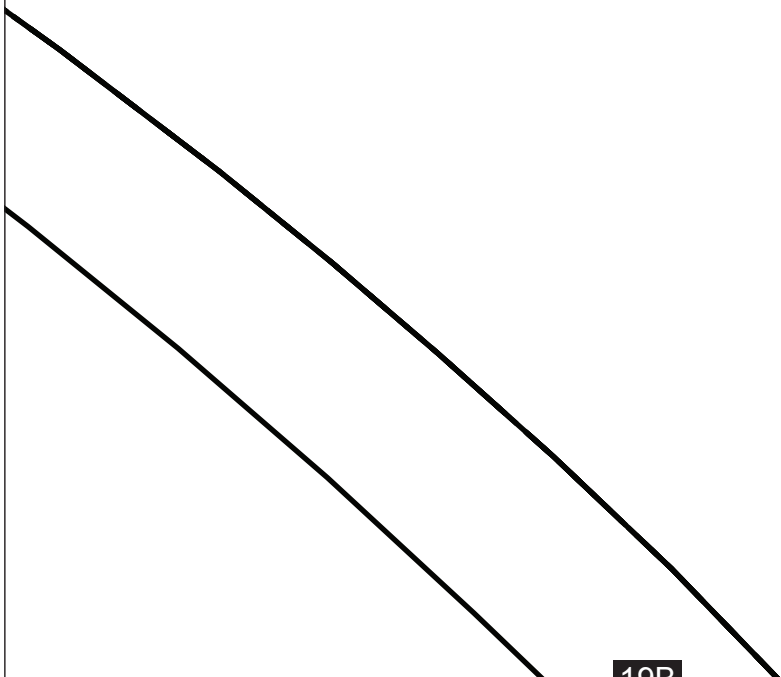

13B

19A

20A

20B

14B

20A

21B

15B

22A

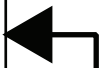

PLACE ON FOLD

CENTRE FRONT FOR CORSET GOWN
CENTRE BACK FOR WALKAWAY DRESS

22B

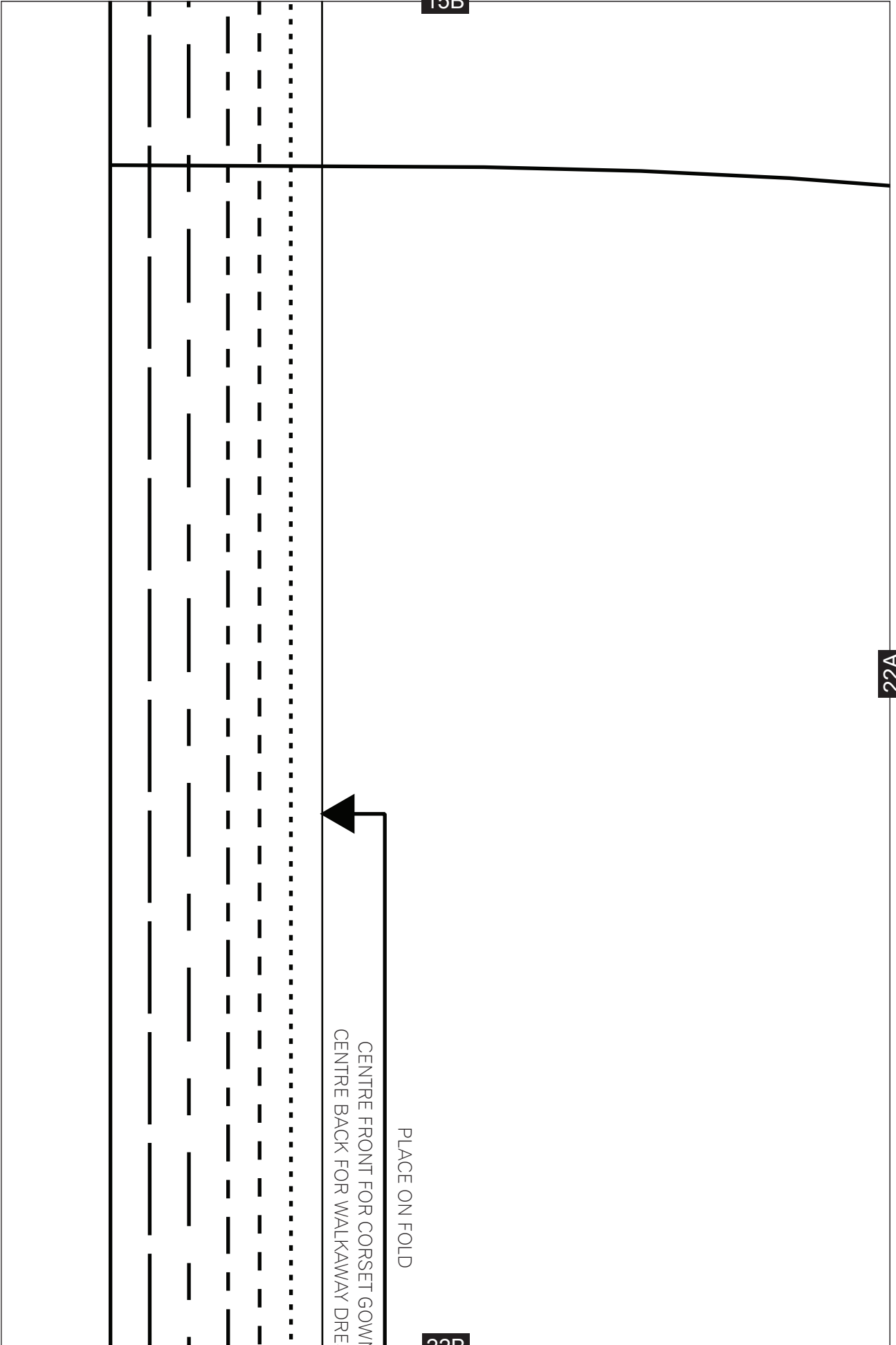

16B

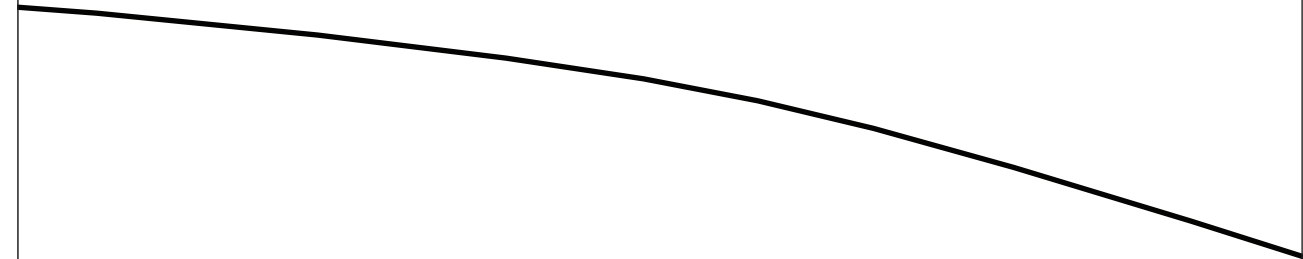

22A

23A



23B

17B

23A

24A

24B

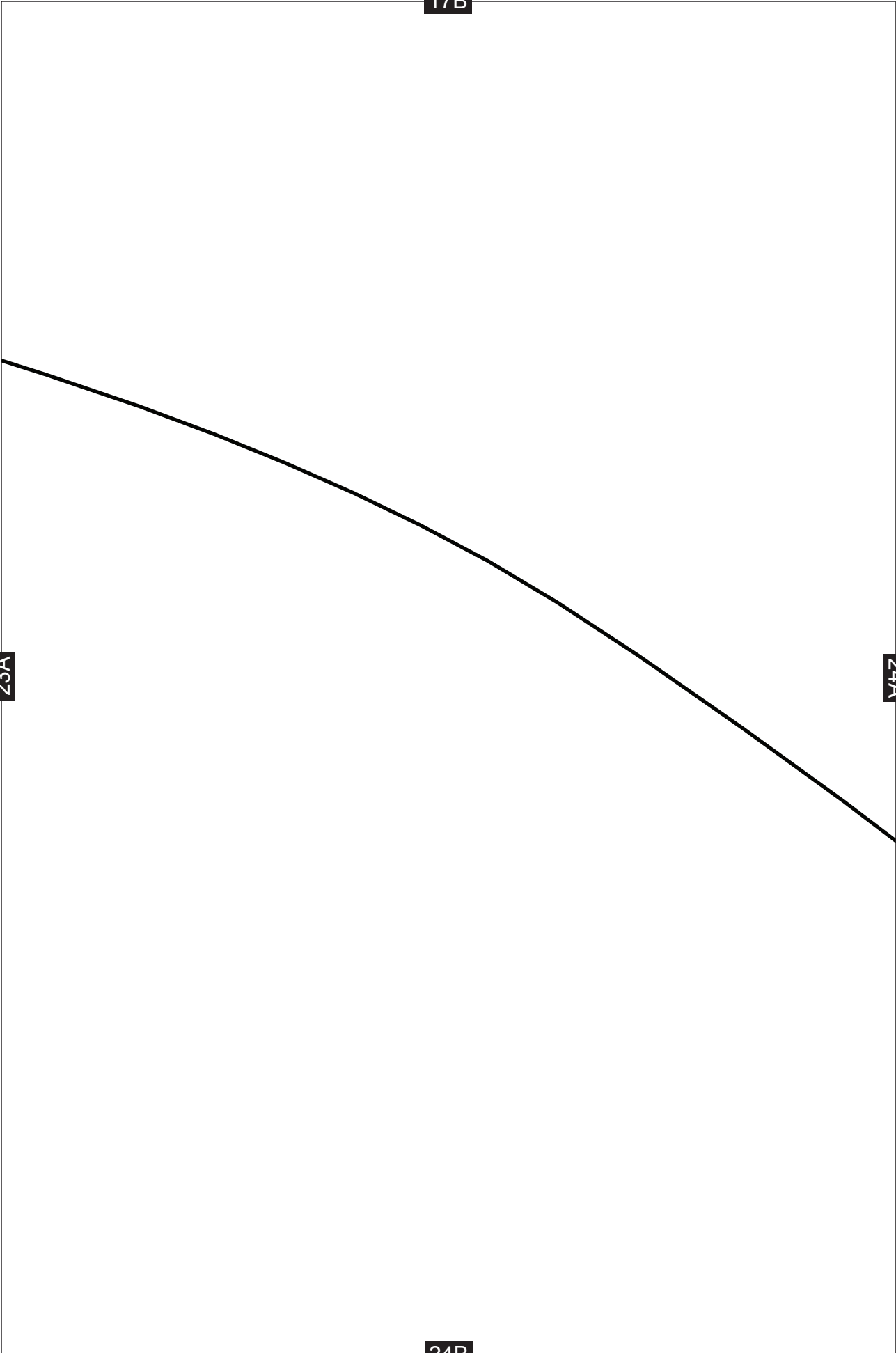

18B

CORSET GOWN

SKIRT - CUT 1 ON FOLD + 2 NOT ON FOLD

24A

25A

25B

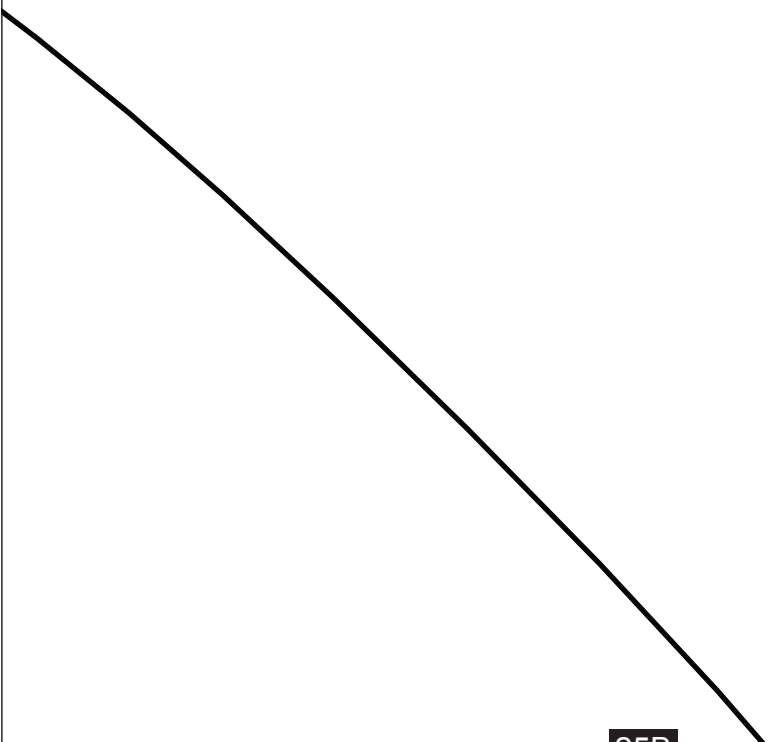

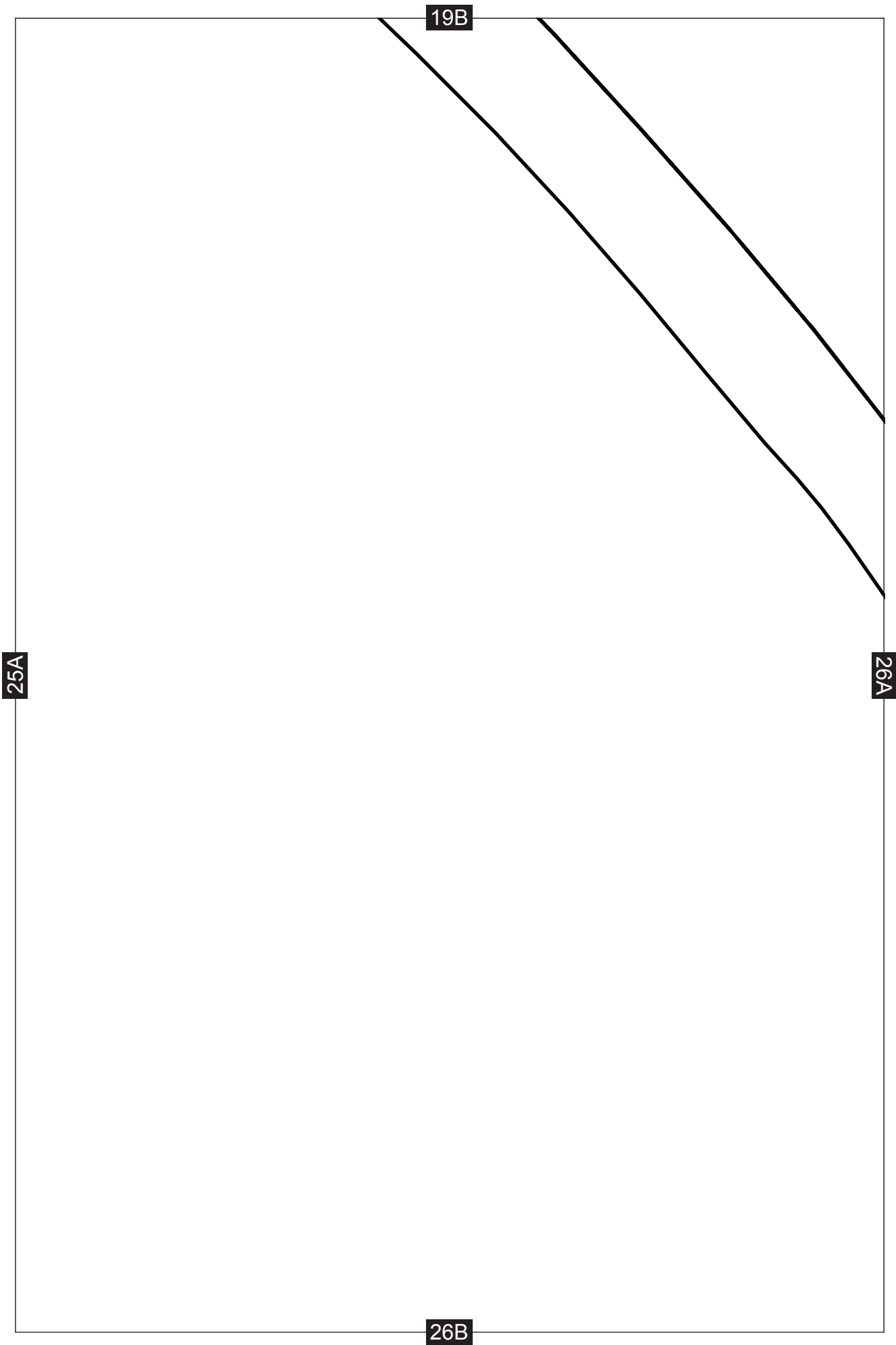

20B

27A

26A

27B

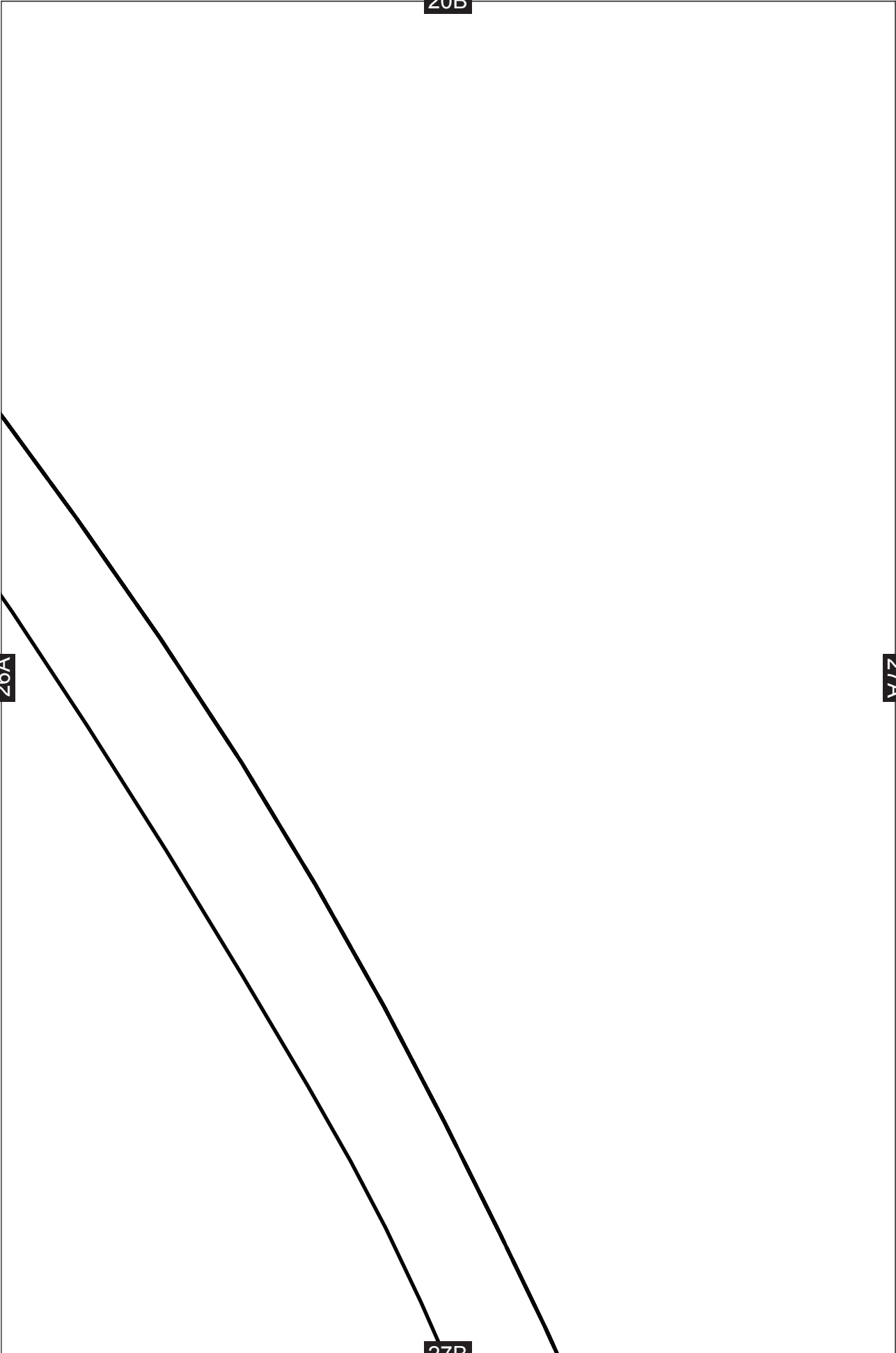

21B

27A

28B

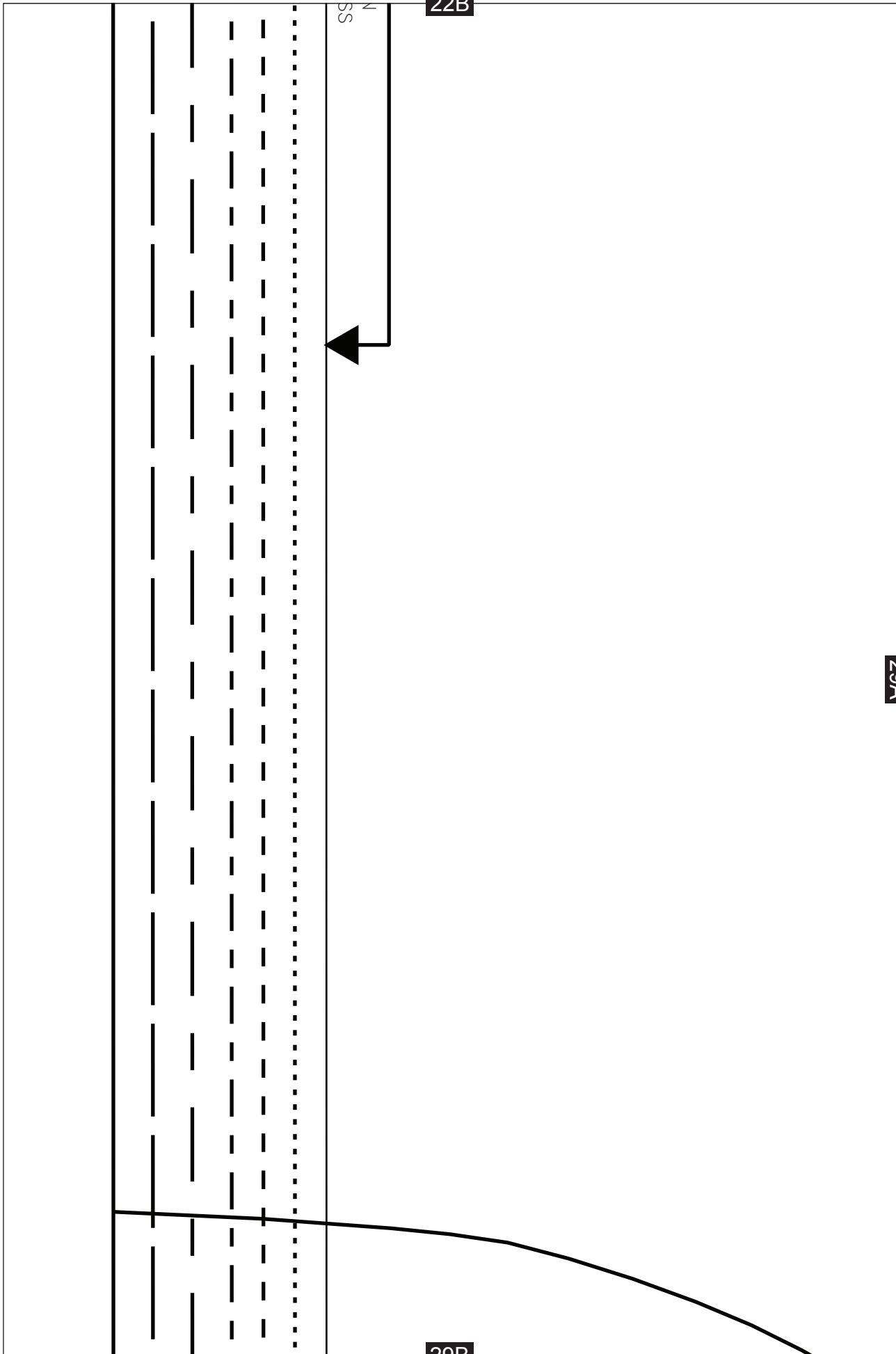

23B

29A

30A

30B

24B

30A

31A

31B

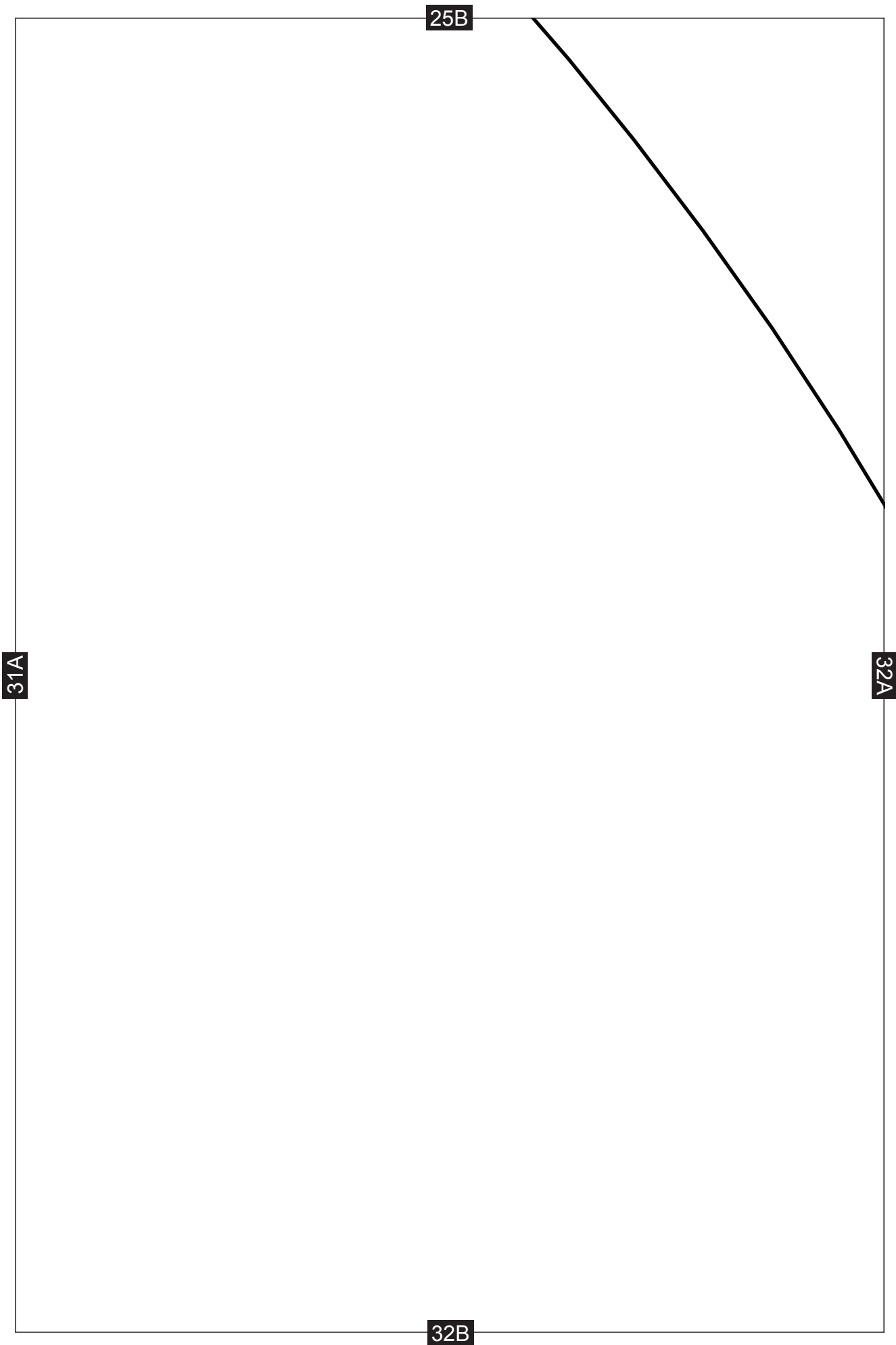

26B

32A

33A

CUT LINE FOR WALKAWAY DRESS

33B

27B

33A

34A

34B

CUT LINE FOR CORSET GOWN UNDERSKIRT
1-CM ($\frac{3}{8}$ -IN) HEM ALLOWANCE INCLUDED

CUT LINE FOR CORSET GOWN OVERSKIRT
3-CM ($1\frac{1}{4}$ -IN) HEM ALLOWANCE INCLUDED

28B

34A

35B

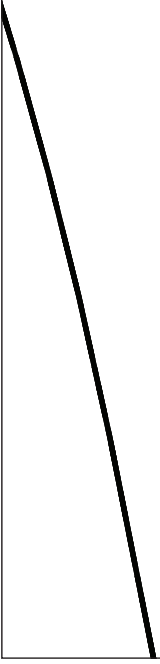

29B

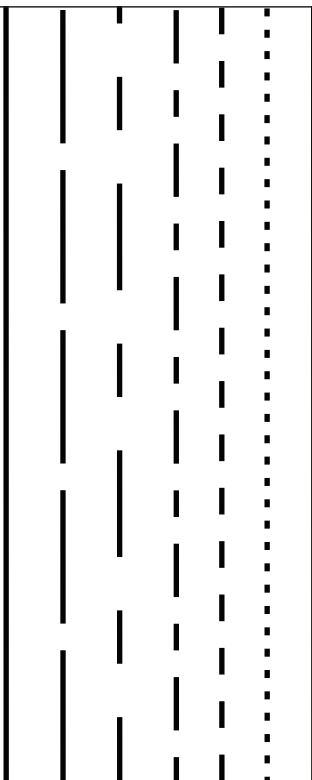

CUT LINE FOR WALKAWAY DRESS

36A

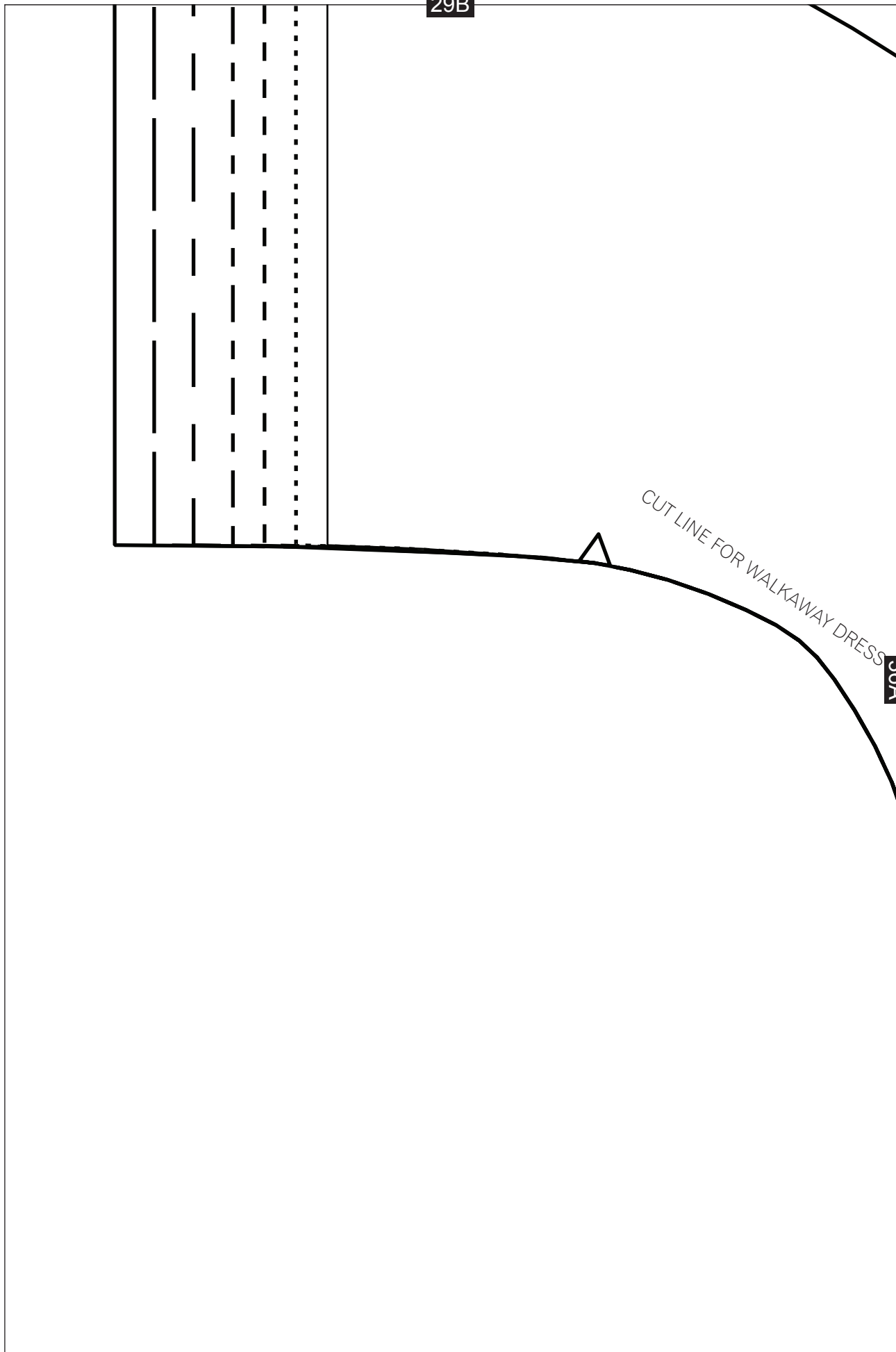

30B

CUT LINE FOR CORSET GOWN

36A

37A

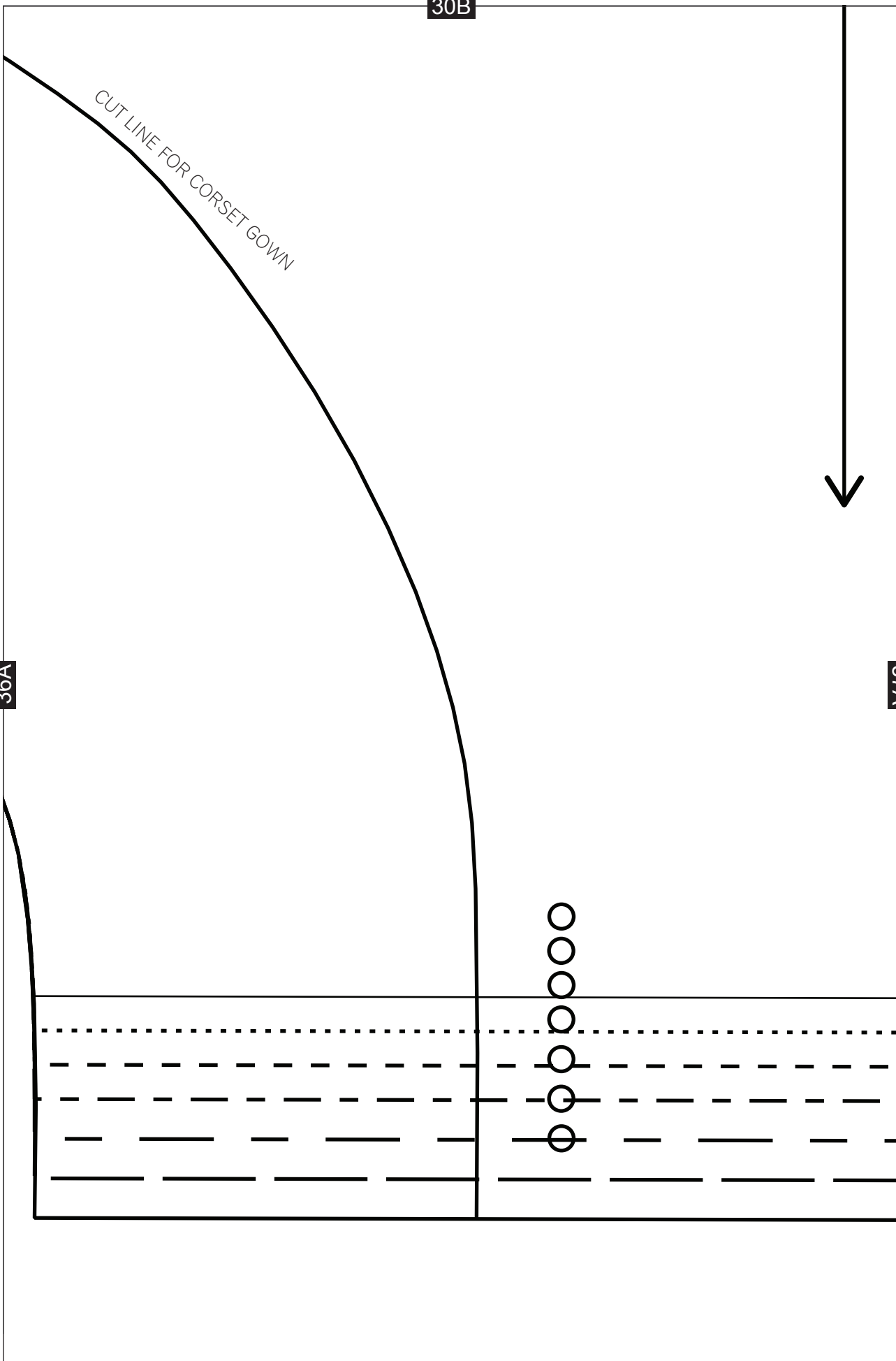

31B

ZIP POSITION FOR CORSET GOWN

38A



37A

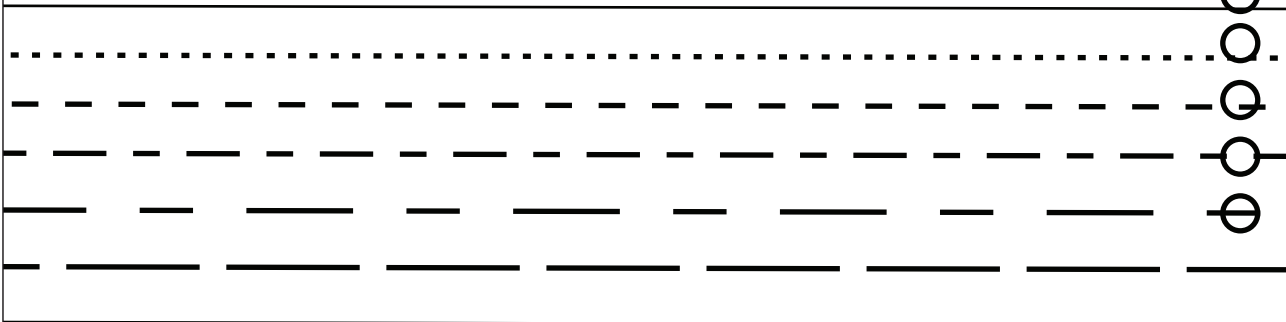

32B

38A

39A

A writing template consisting of four horizontal lines: a solid top line, a dotted midline, a dashed baseline, and a solid bottom line. The area between the top and bottom lines is intended for handwriting practice.

33B

39A

40A

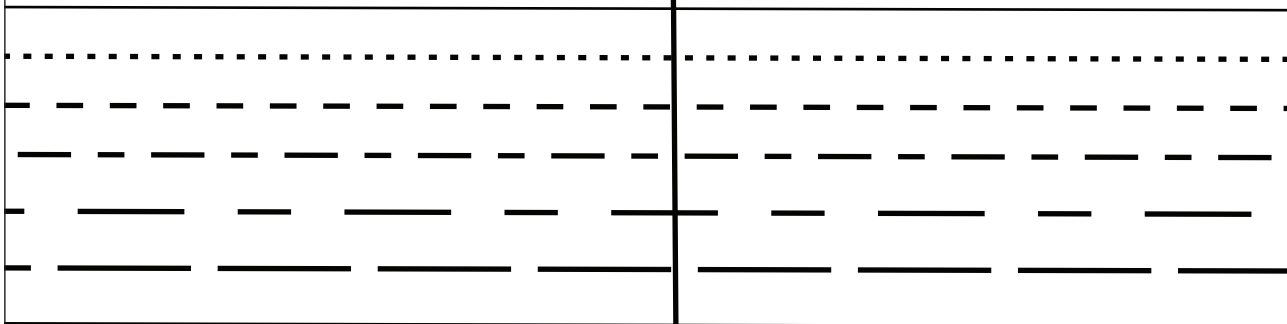

34B

40A

41A

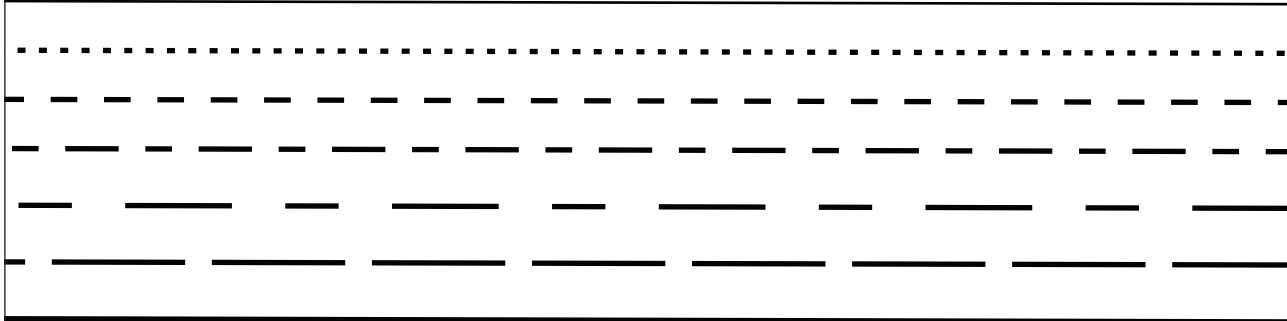

35B

41A

