

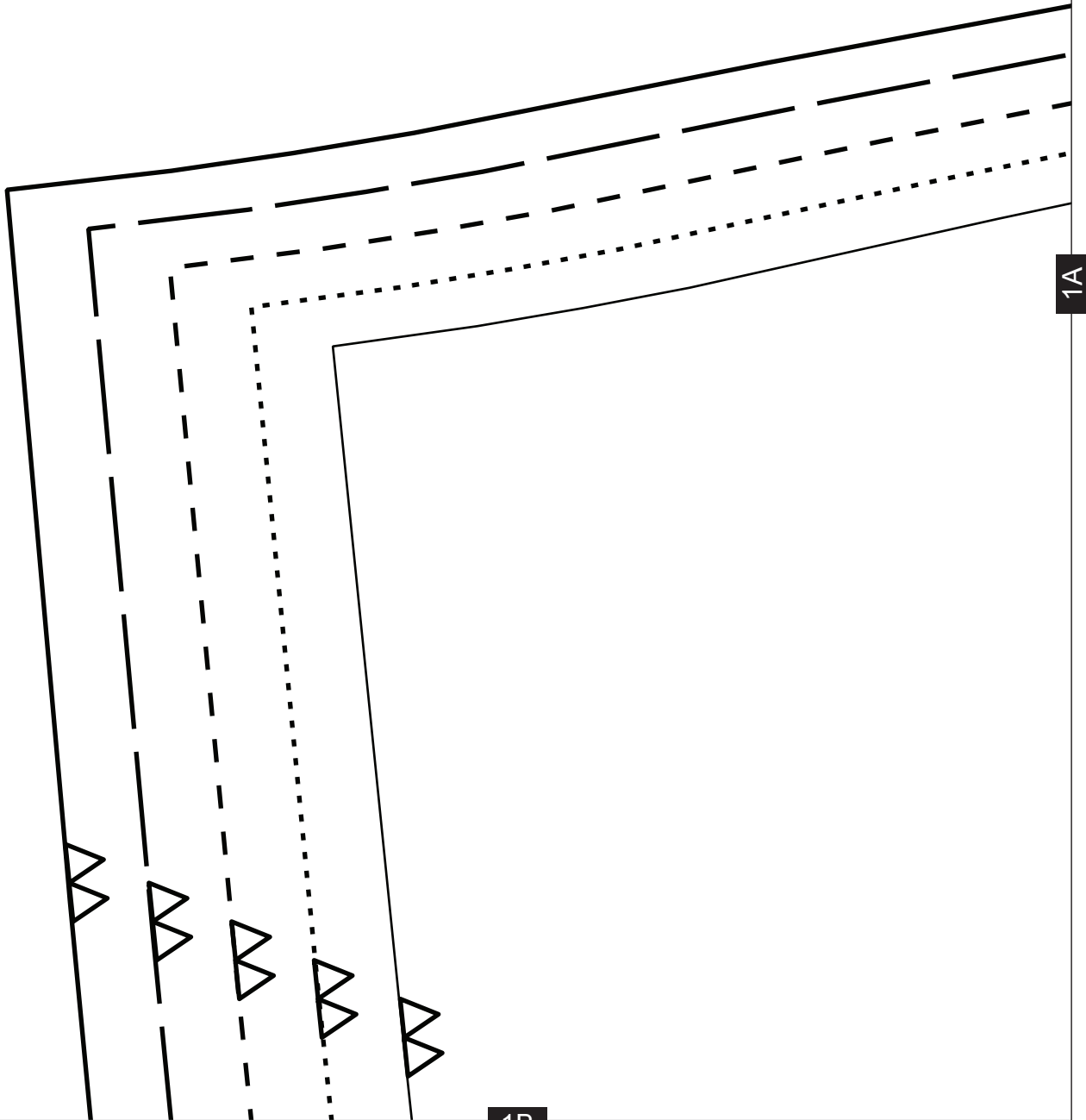

XS _____
S
M - - - - -
L _____
XL _____

Sleeved Stripey Knit Dress
Project design © Love Productions 2015
This design is protected by copyright and
must not be made for resale.



1A

1B

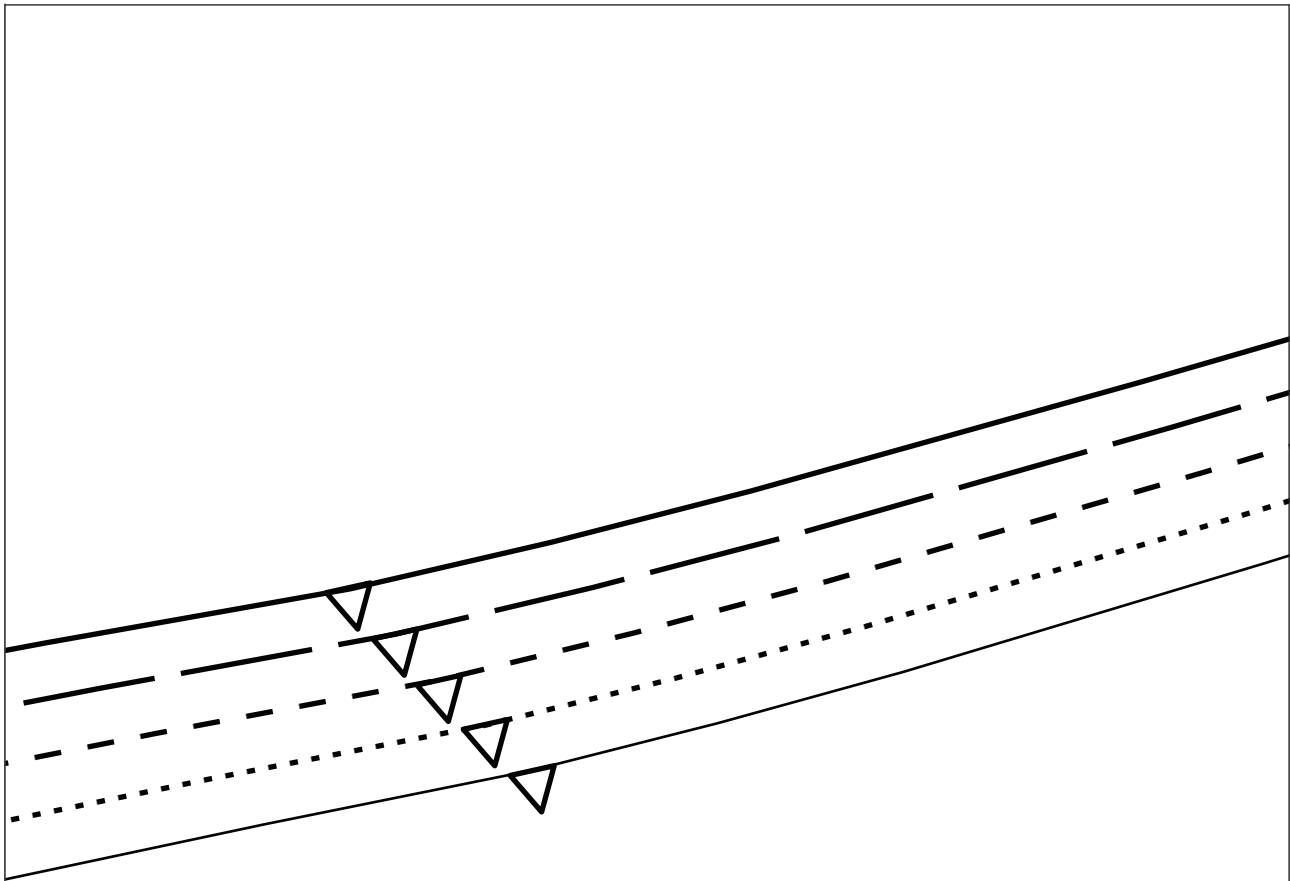

1A

2A

SLEEVED STRIPY KNIT DRESS

BACK - CUT 1 ON FOLD

2B

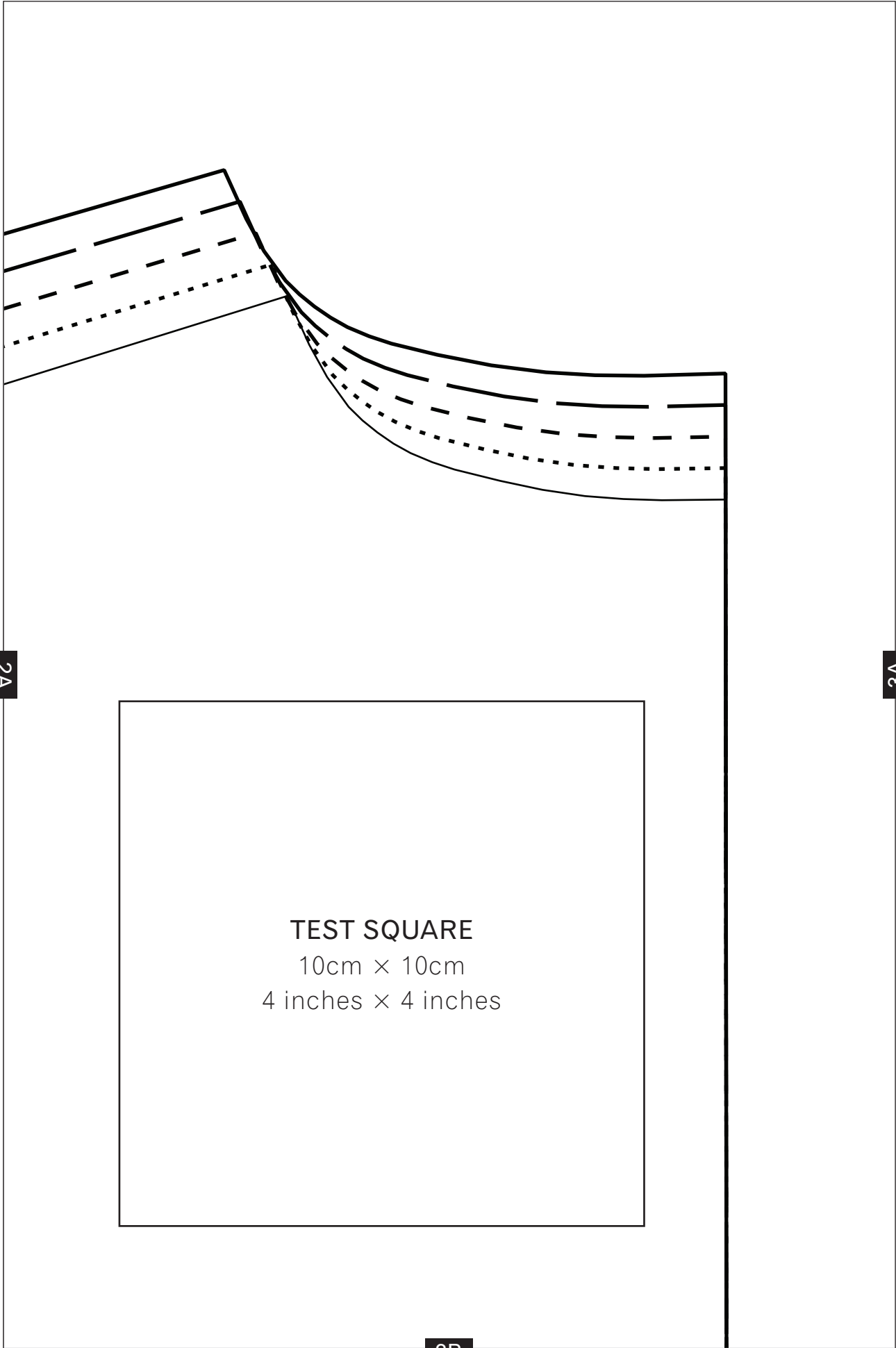

2A

3A

TEST SQUARE
10cm × 10cm
4 inches × 4 inches

3B

3A

4A

4B

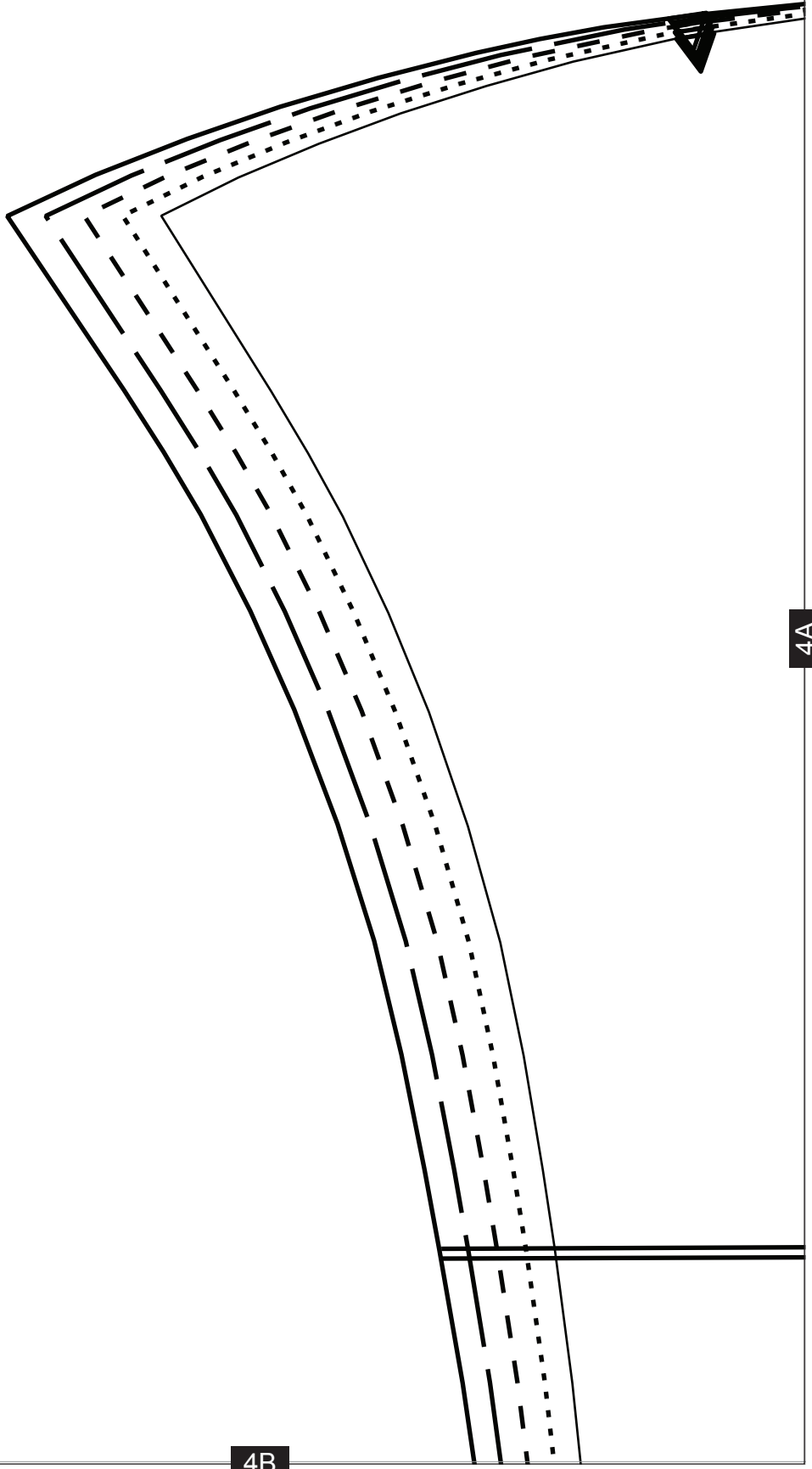

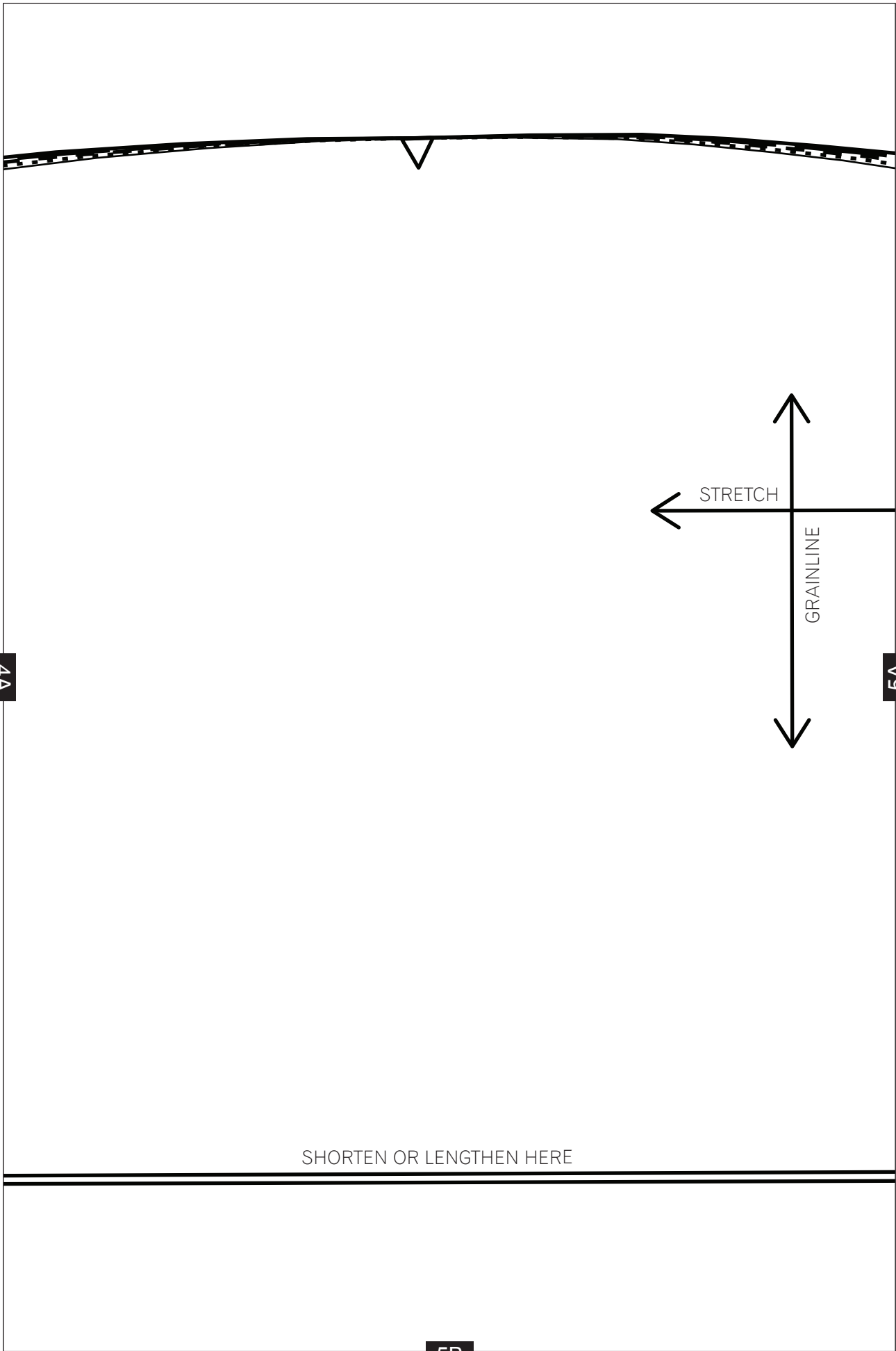

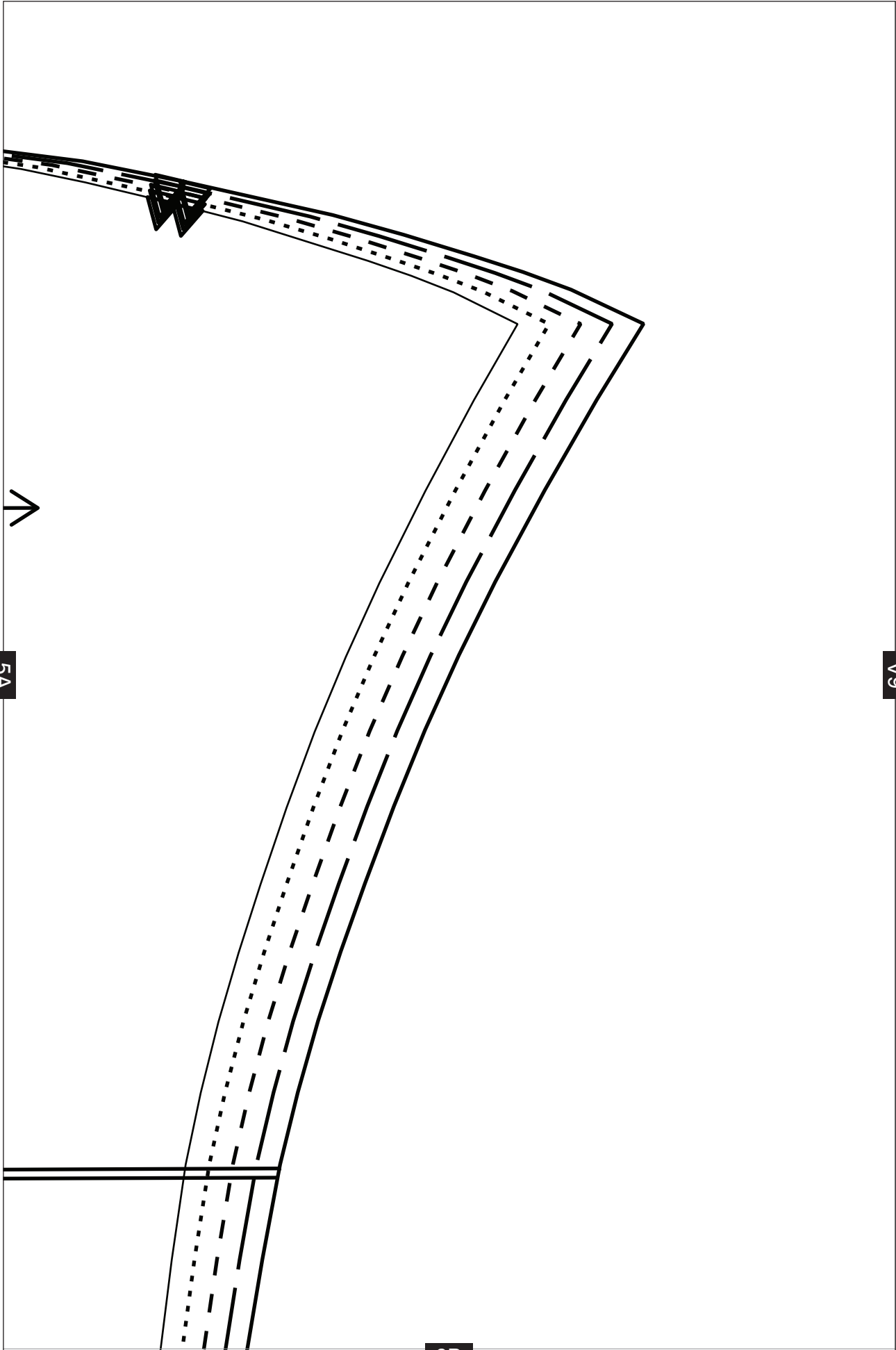

5A

6A

6B

6A

7A

7B

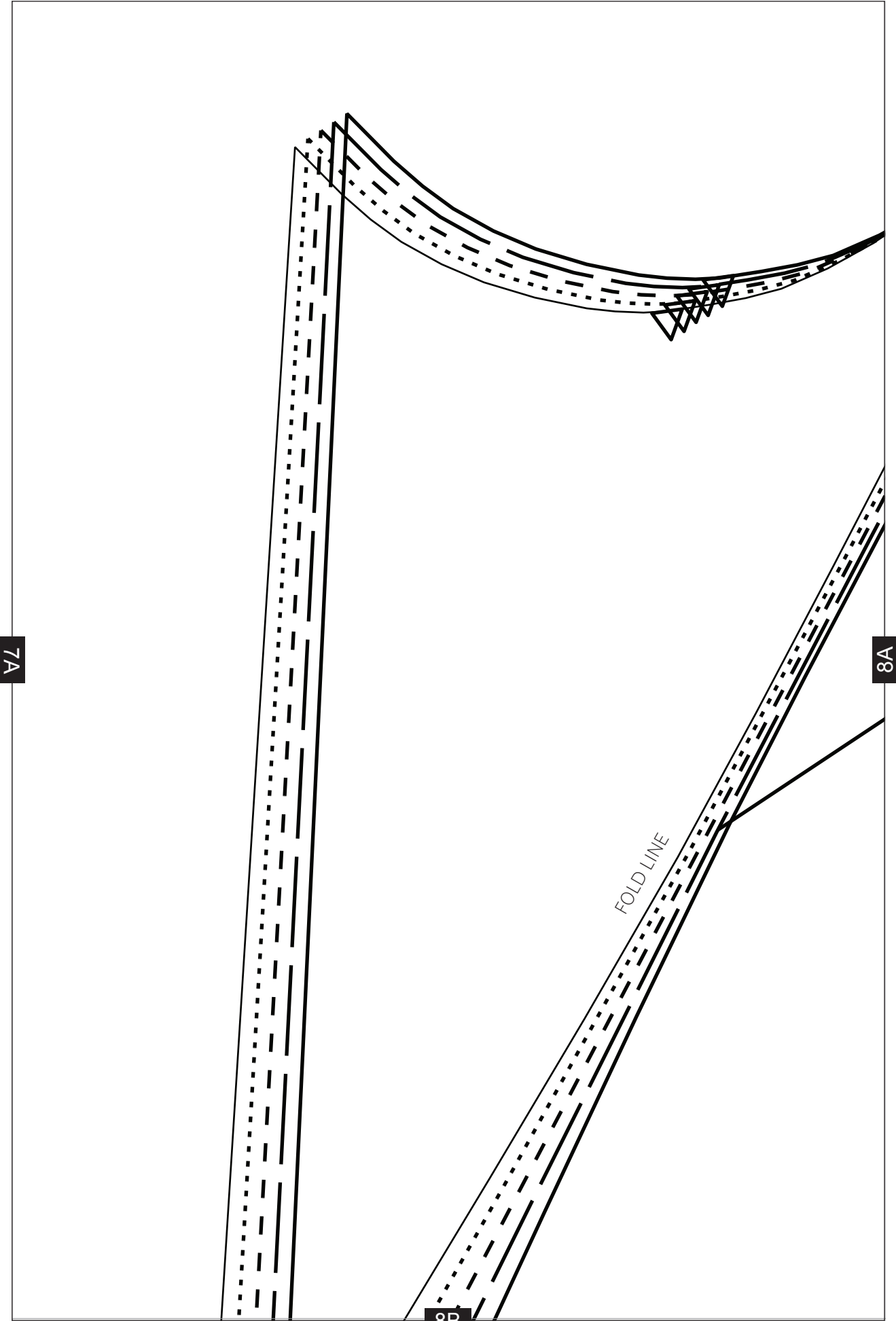

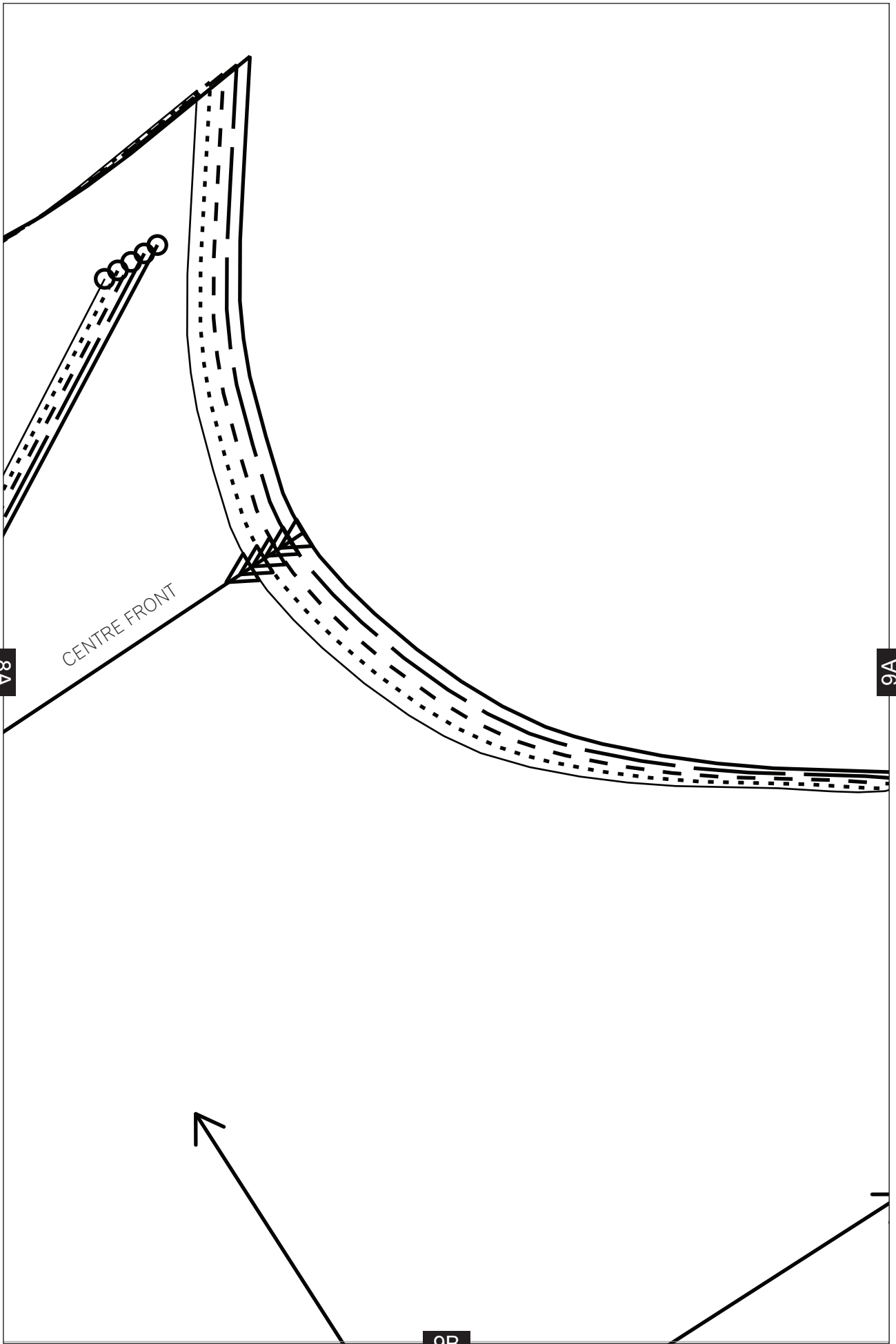

9A

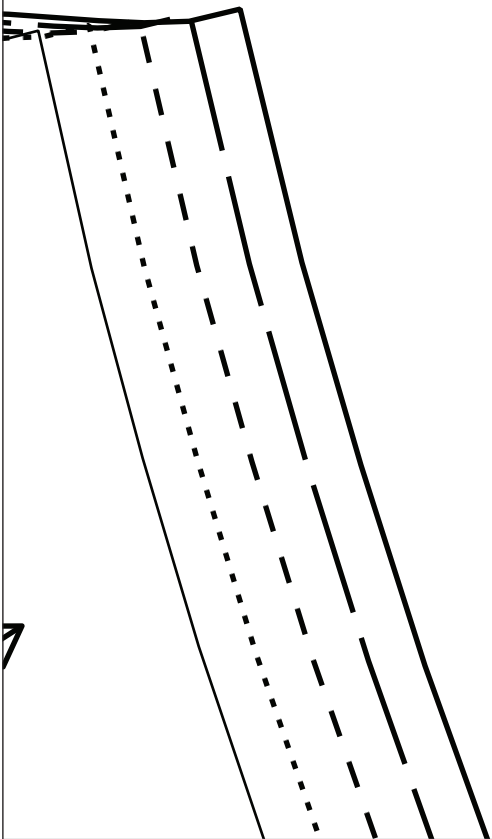

10B

1B

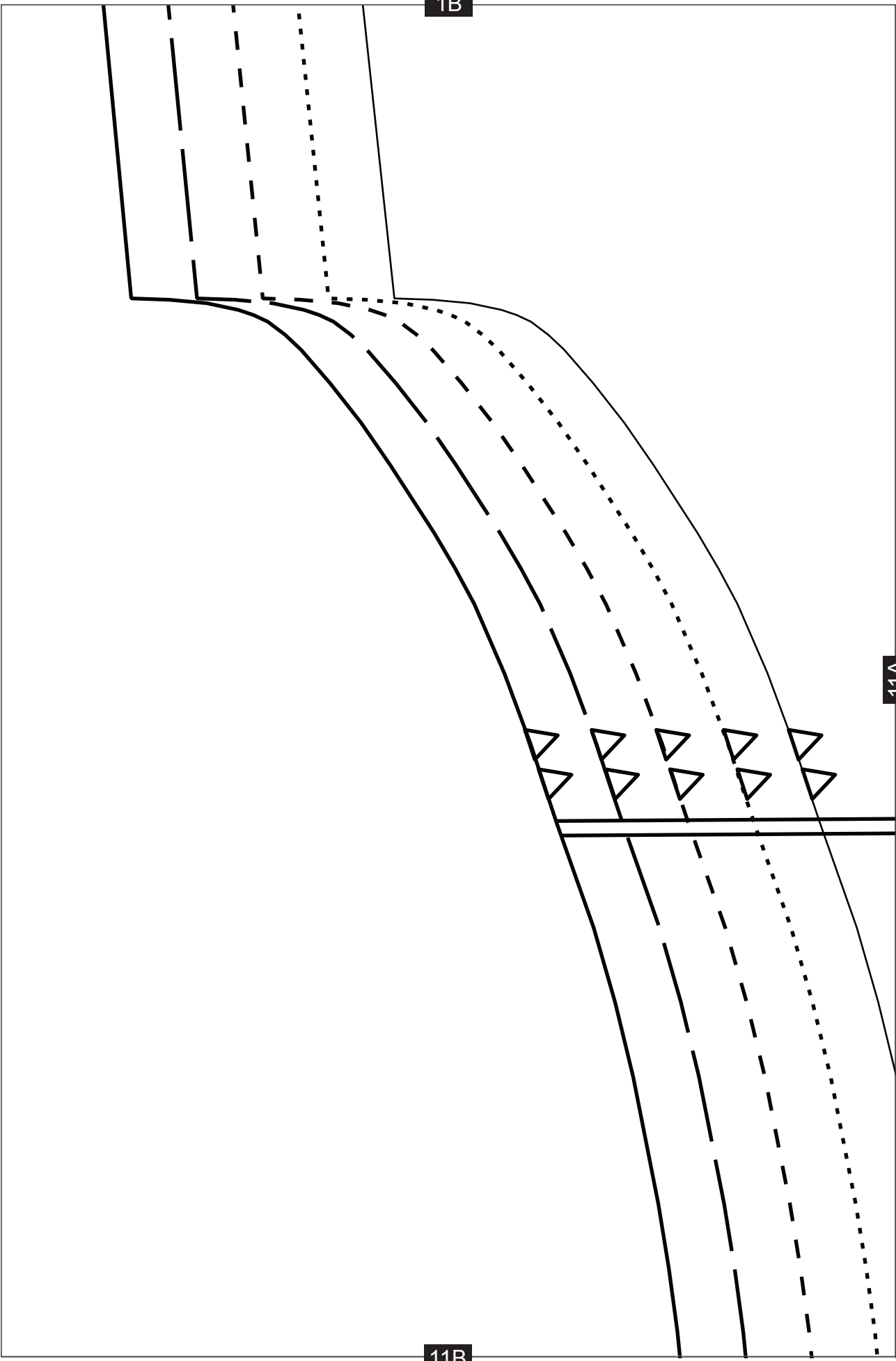

11A

11B

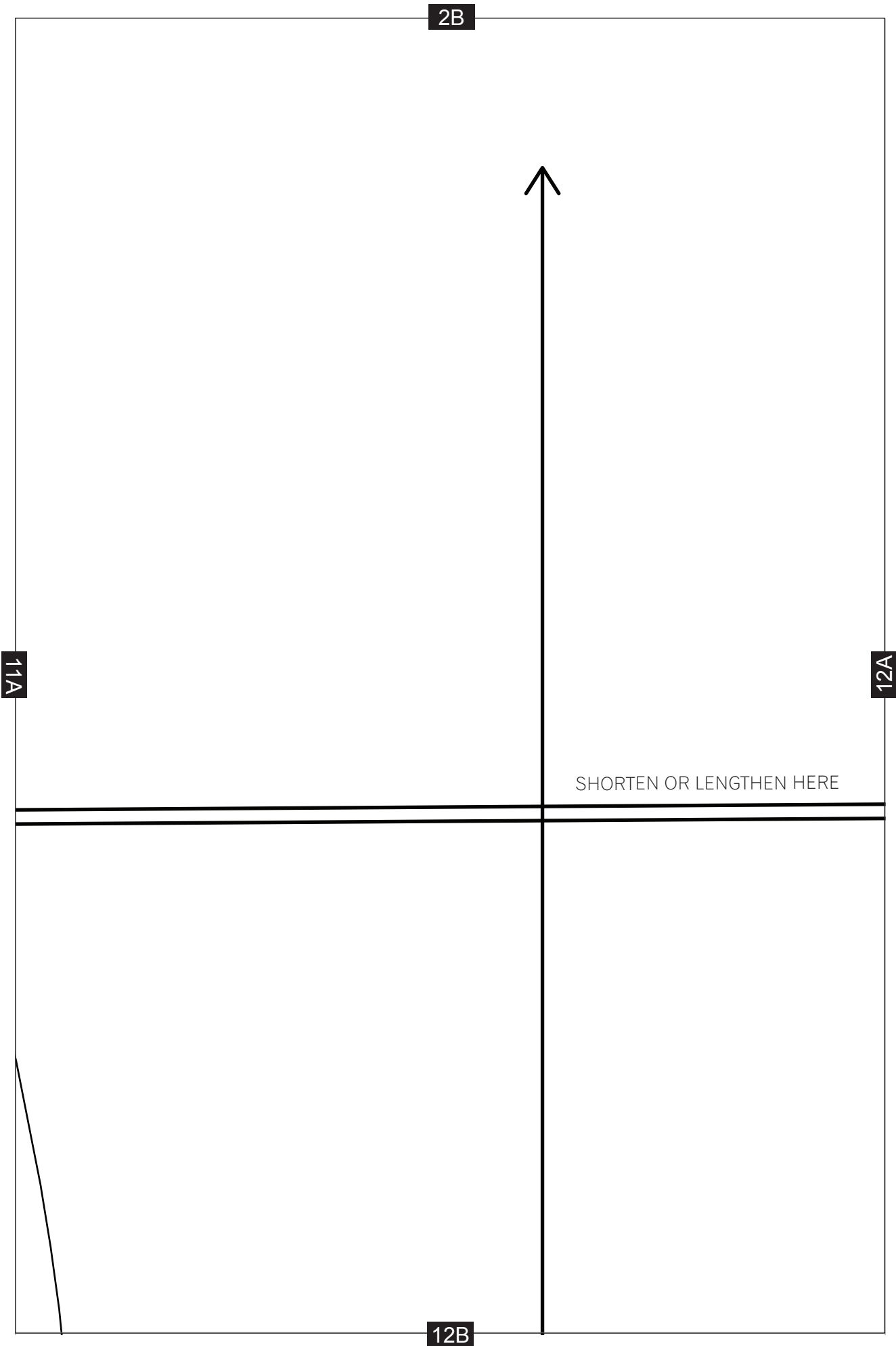

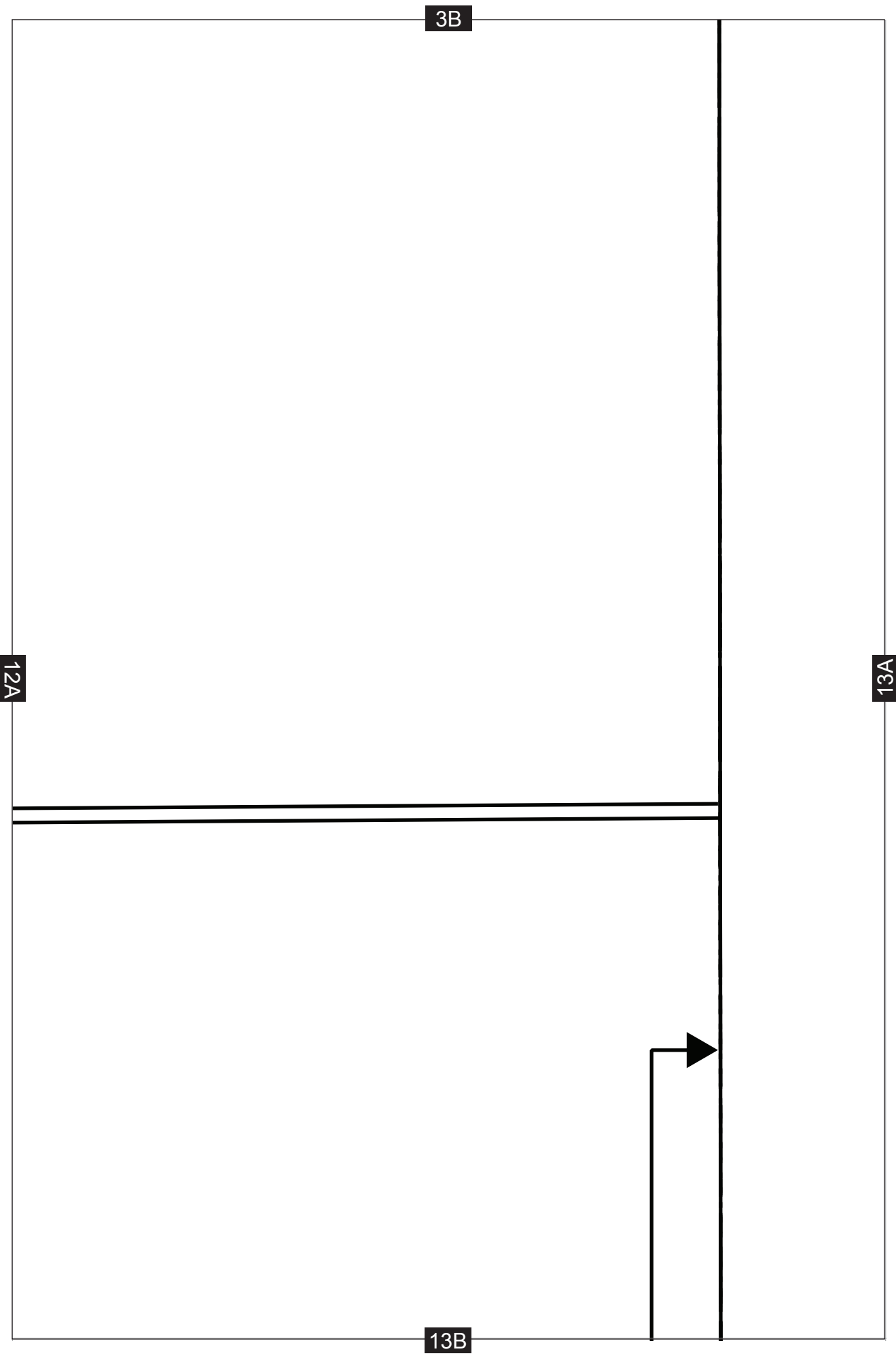

12A

3B

13A

13B

4B

13A

14A

14B

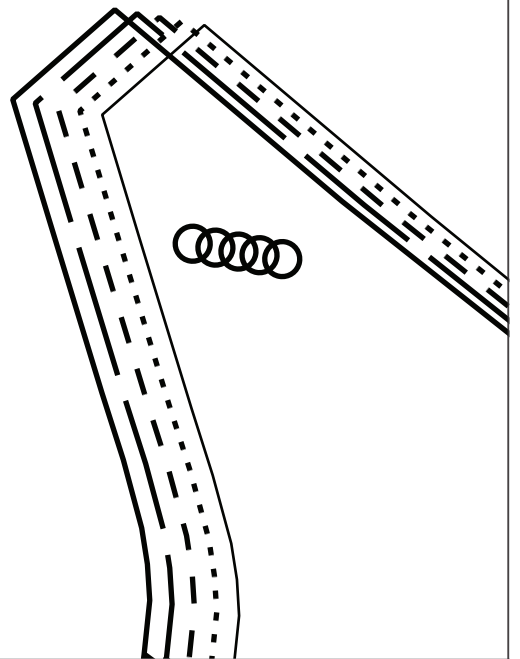

5B

SLEEVED STRIPY KNIT DRESS

OPTIONAL SLEEVE – CUT 2

14A

15A

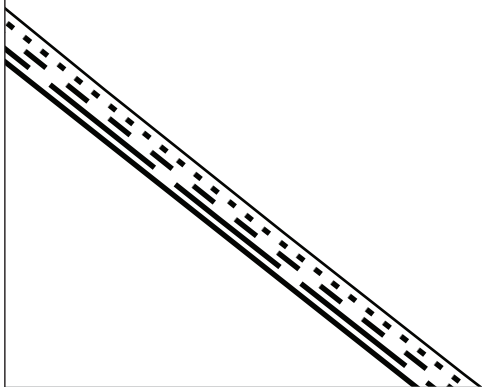
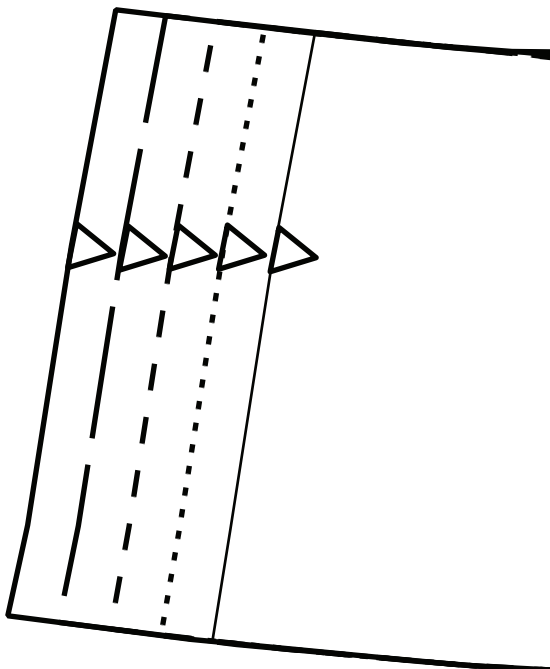

15B

6B

15A

16A

**SLEEVED
STRIPY KNIT DRESS**
FRONT FACING - CUT 1 ON FOLD

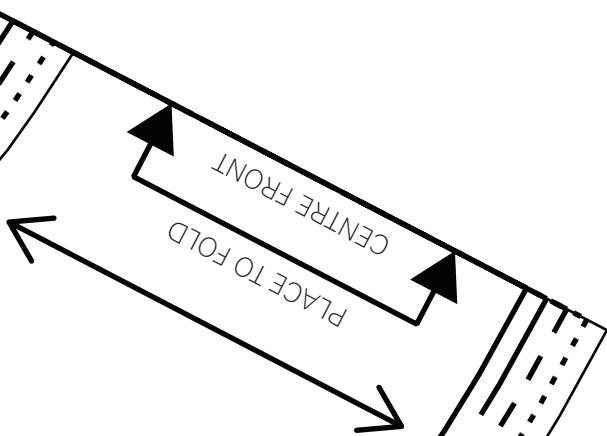

16B

7B

16A

17A

17B

OPTIONAL CUT LINE

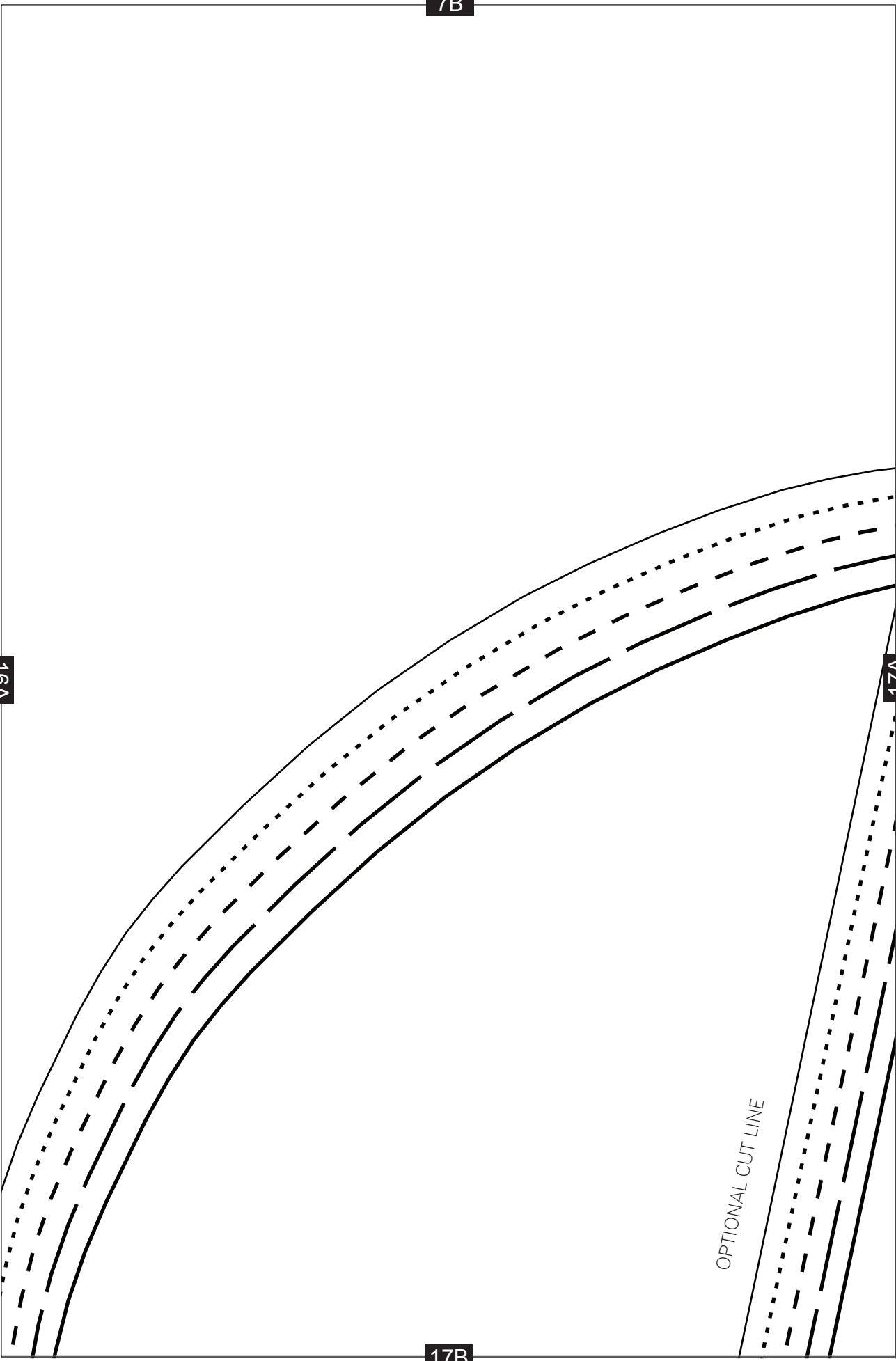

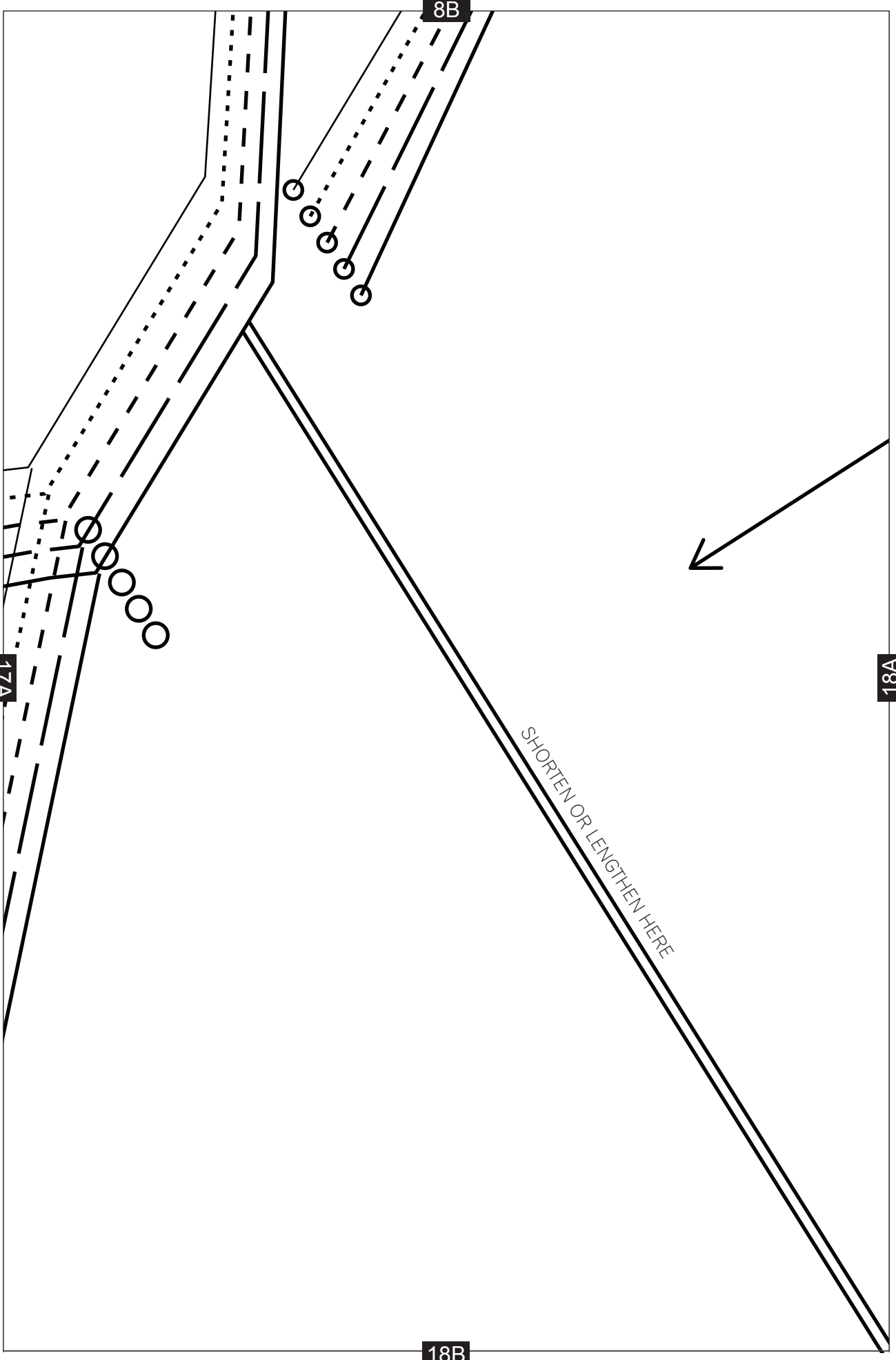

9B

STRETCH

GRAINLINE



18A

SLEEVED STRIPY KNIT DRESS

FRONT LEFT - CUT 1

19A



19B

10B

19A

20B

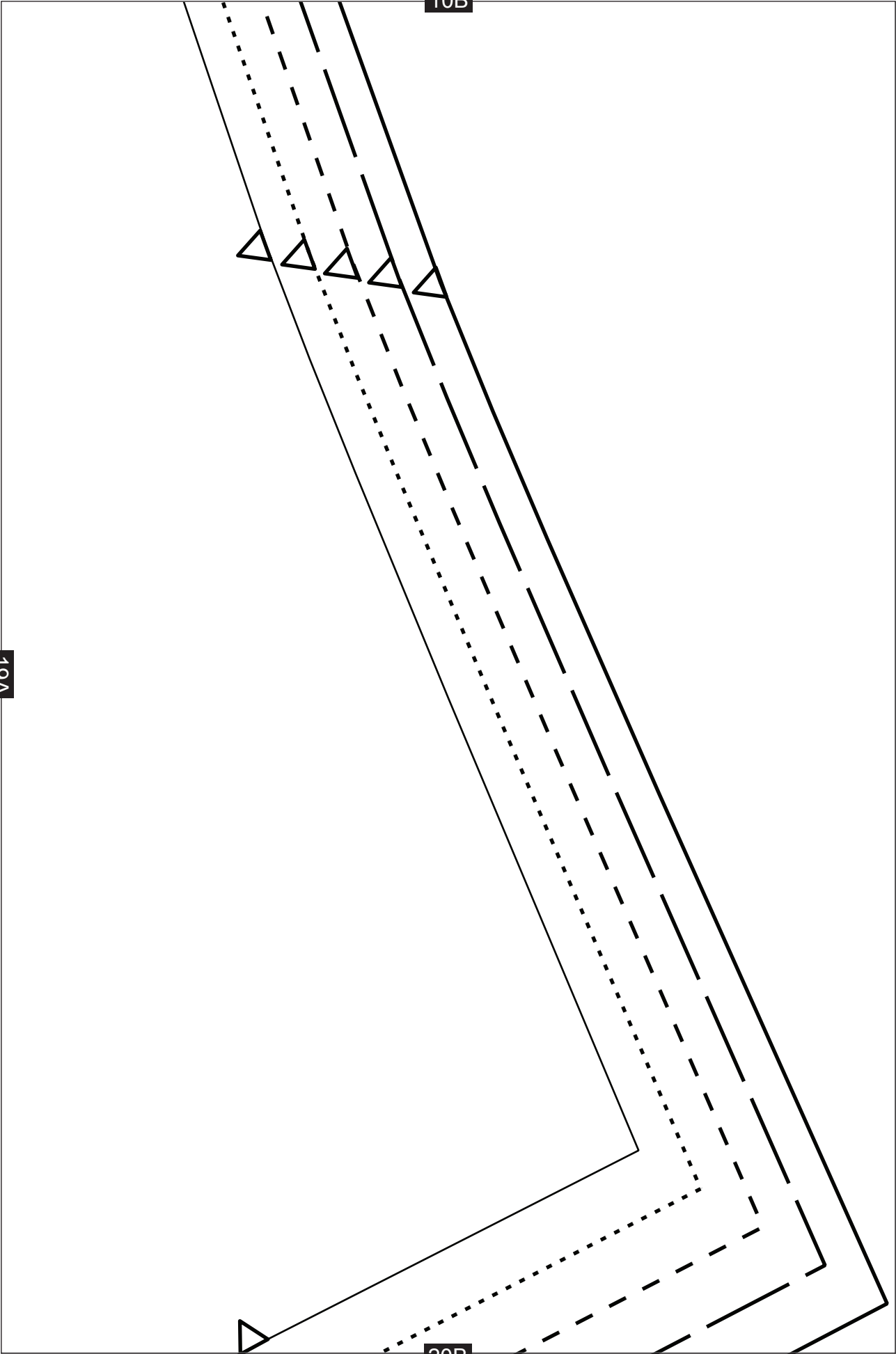

11B

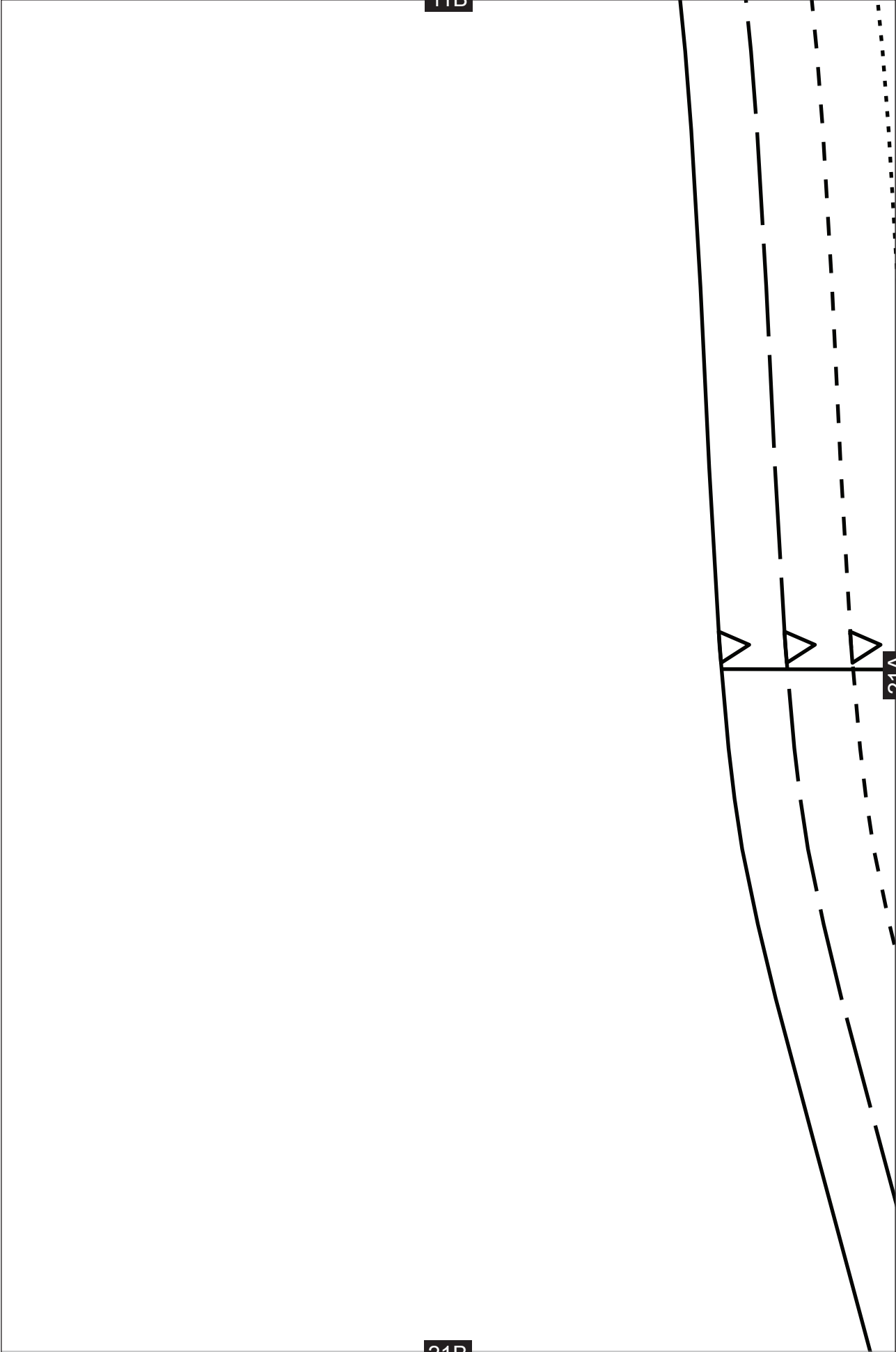

21A

21B

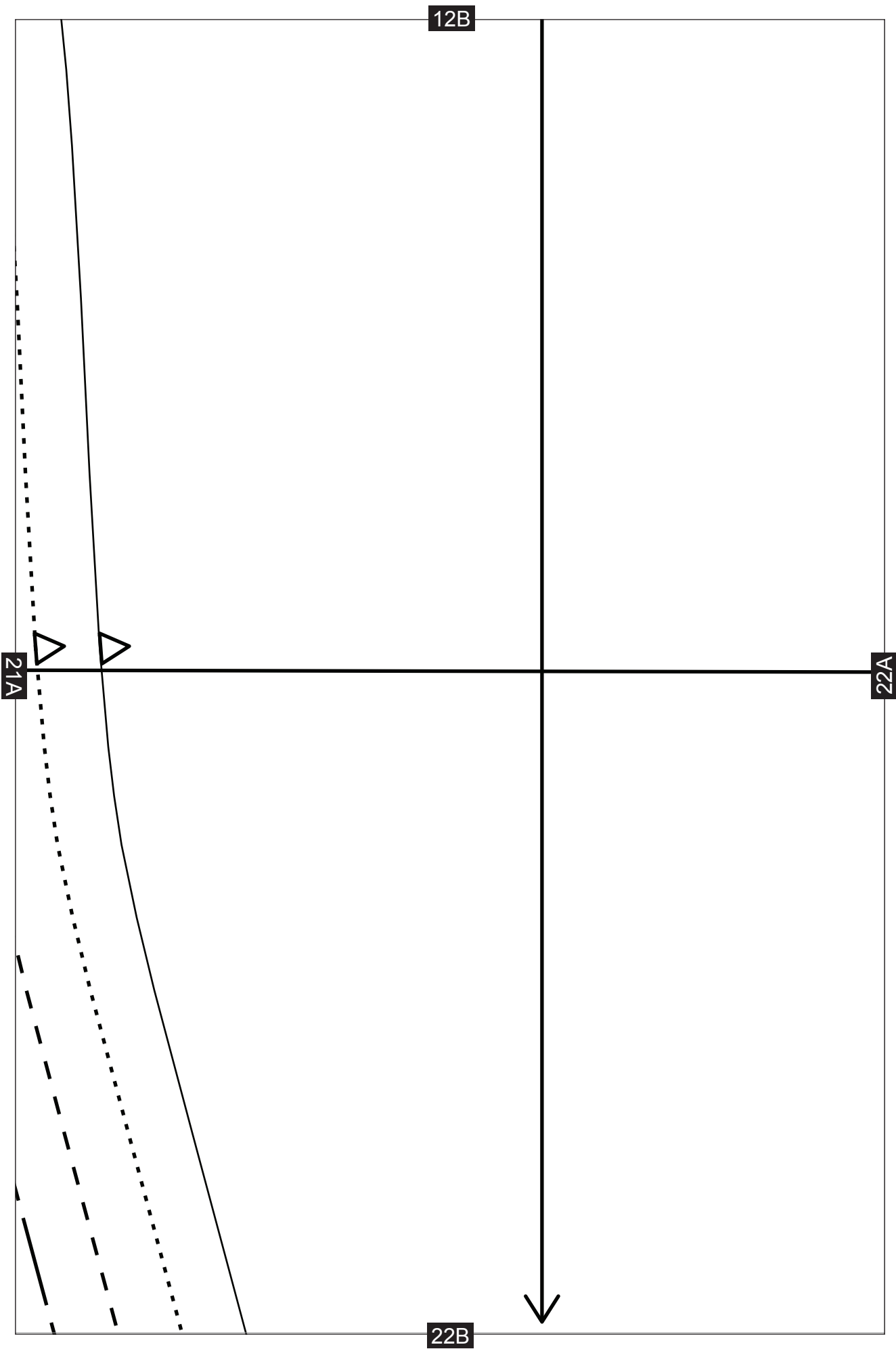

13B

PLACE TO FOLD

CENTRE BACK

OPTIONAL CUT LINE FOR SPLIT BACK

22A

23A

23B

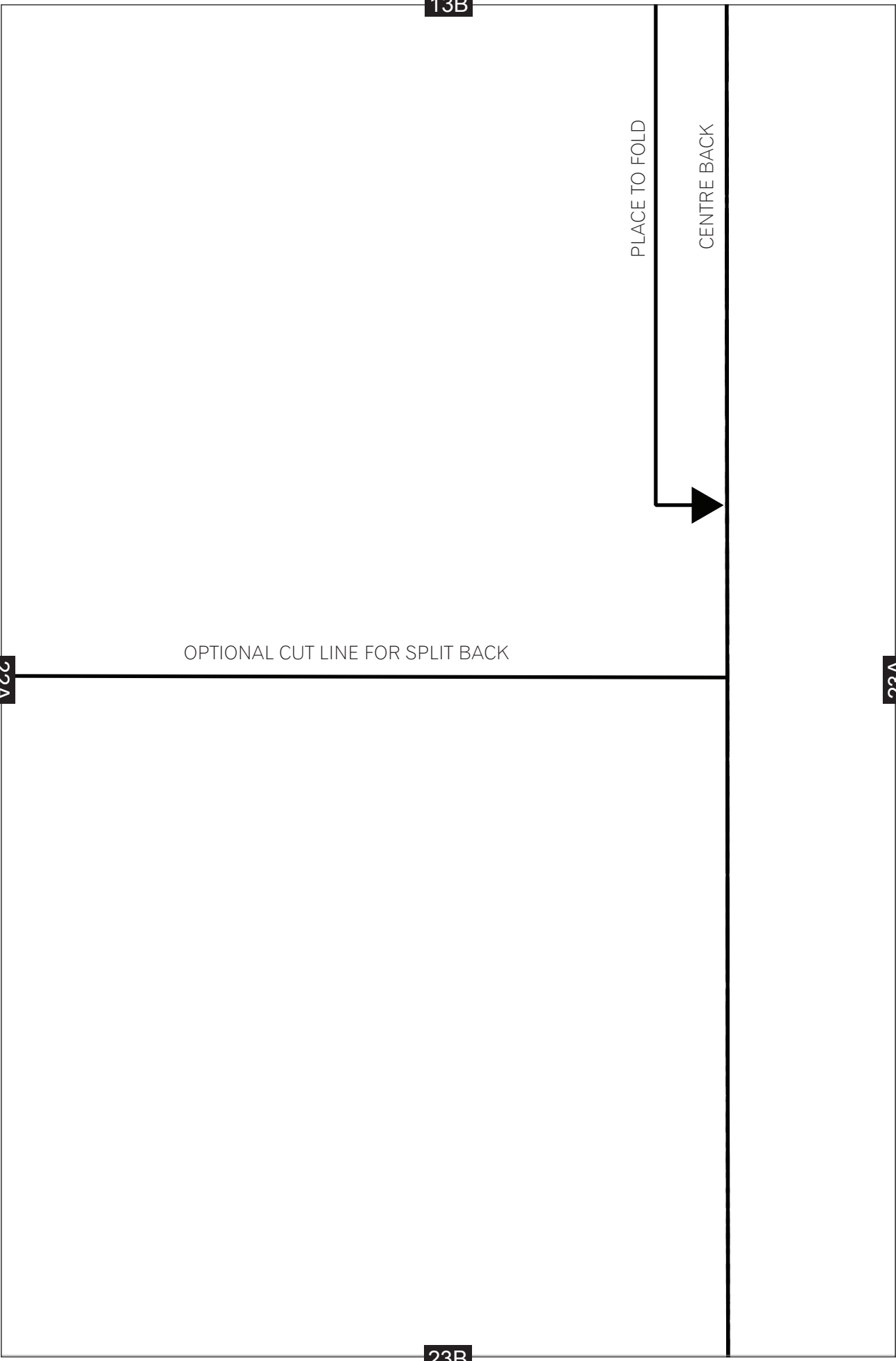

14B

23A

24A

24B

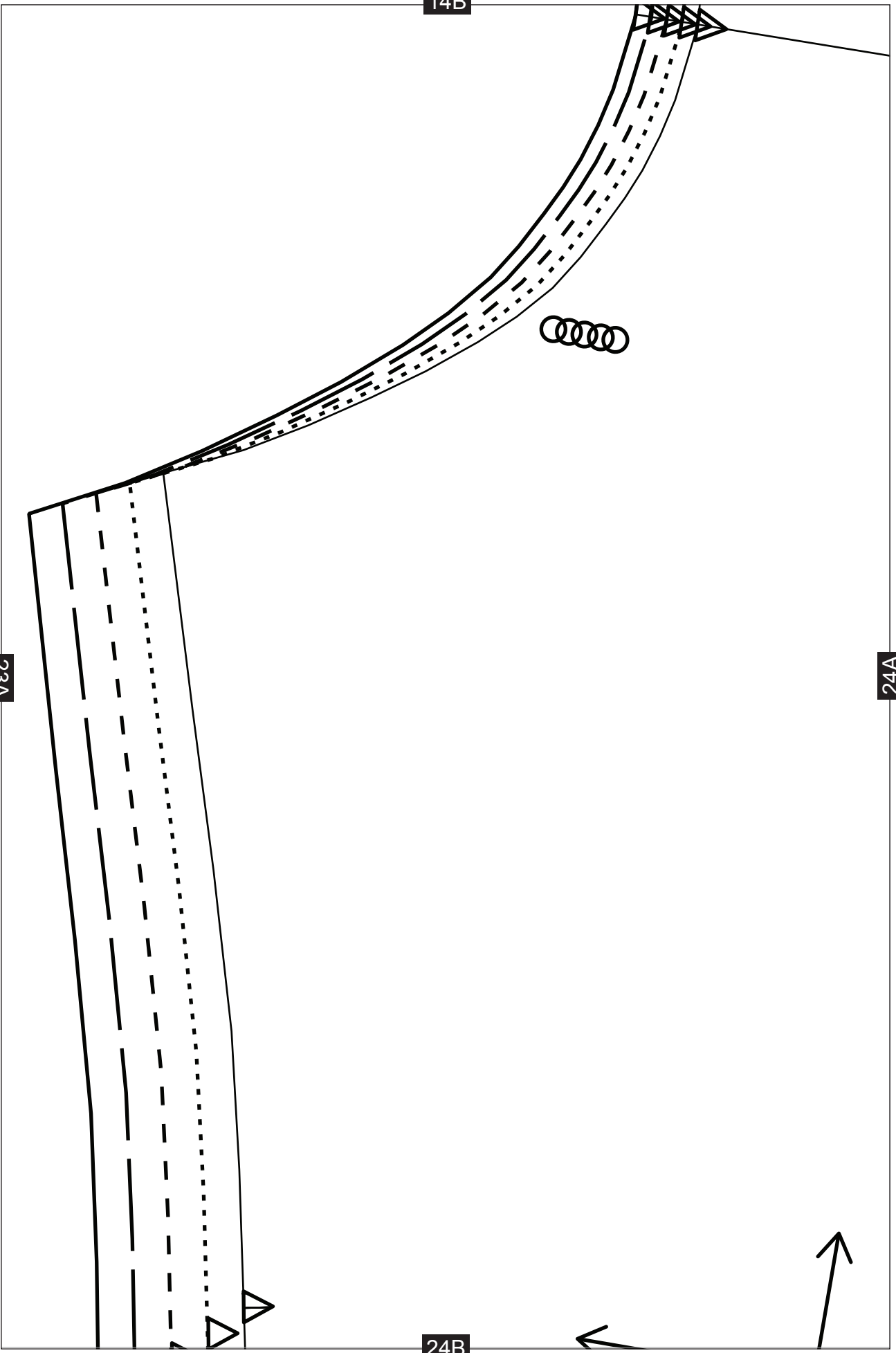

15B

CENTRE FRONT

24A

25A

**SLEEVED STRIPY
KNIT DRESS**
FRONT RIGHT - CUT 1

25B

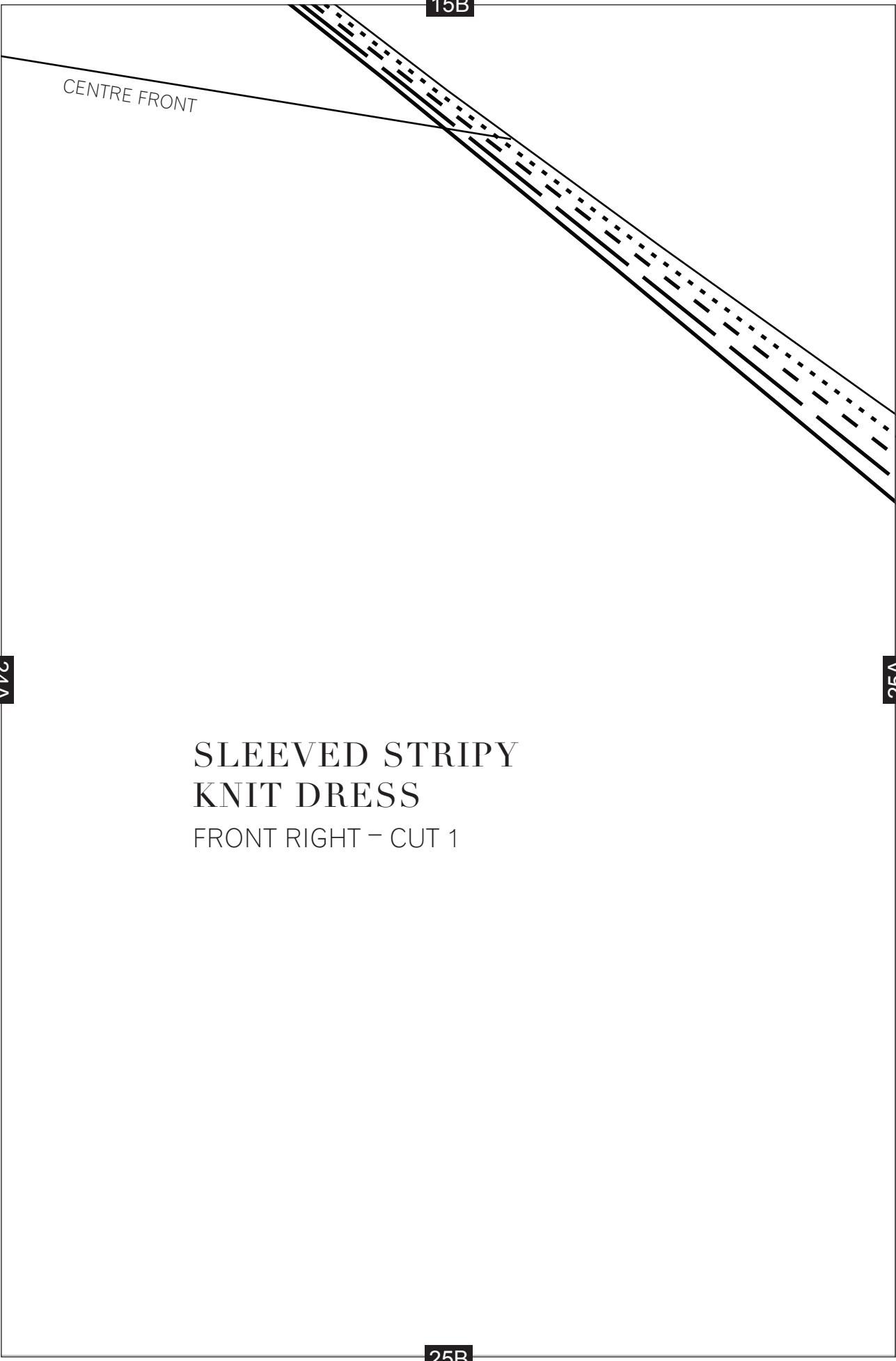

16B

25A

26A

26B

SHORTEN OR LENGTHEN HERE

OPTIONAL CUT LINE

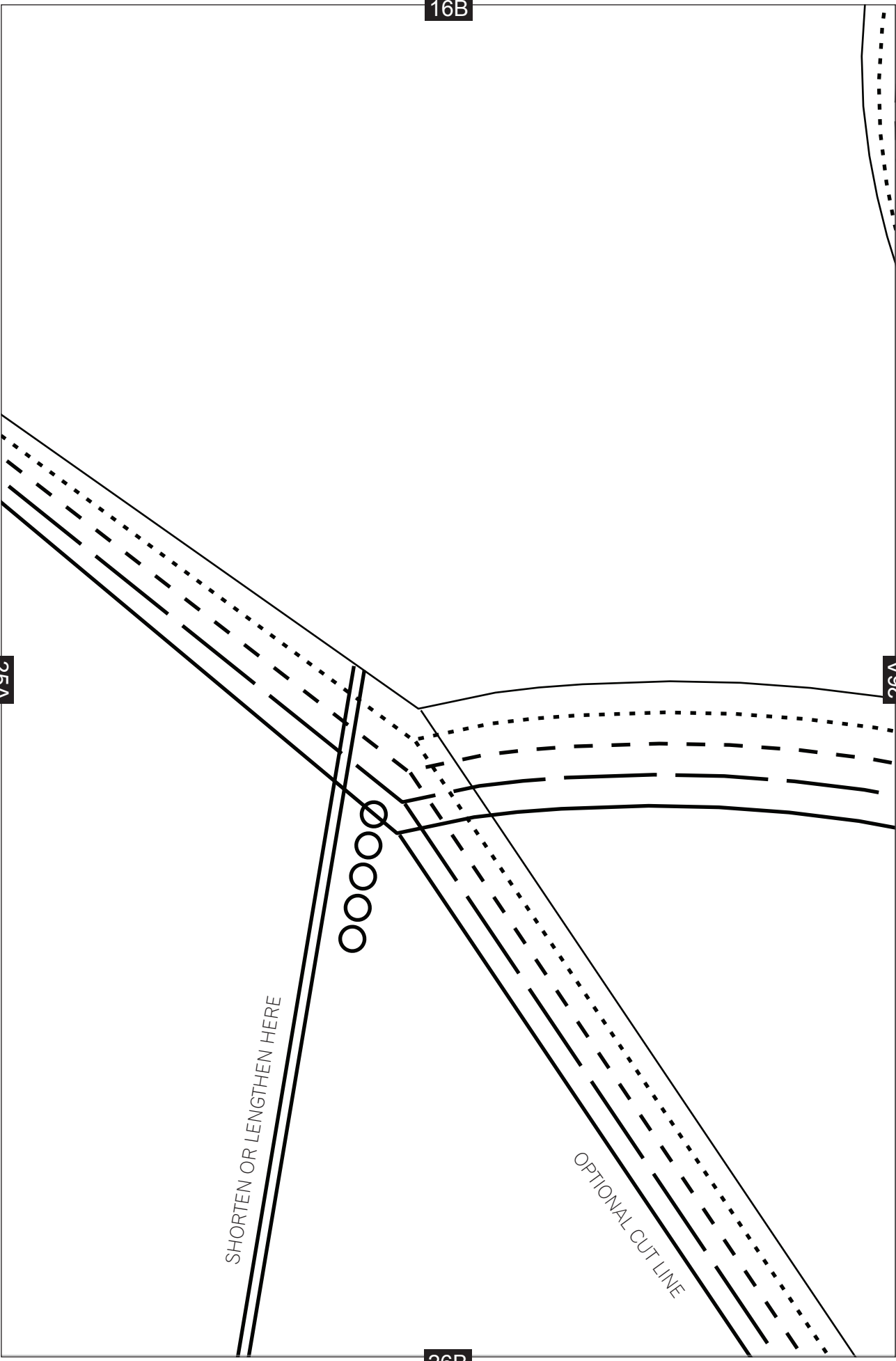
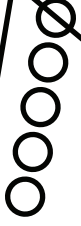

17B

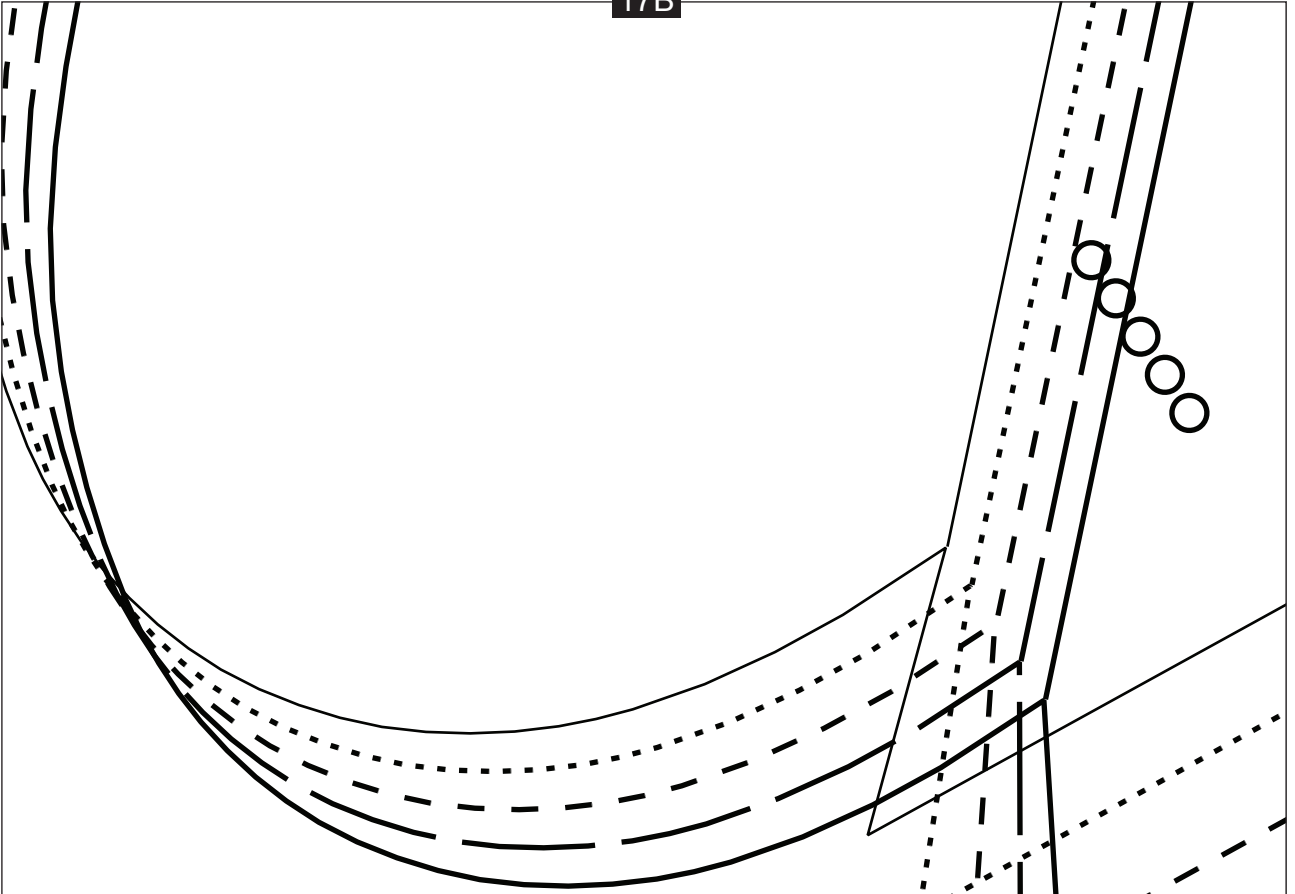

26A

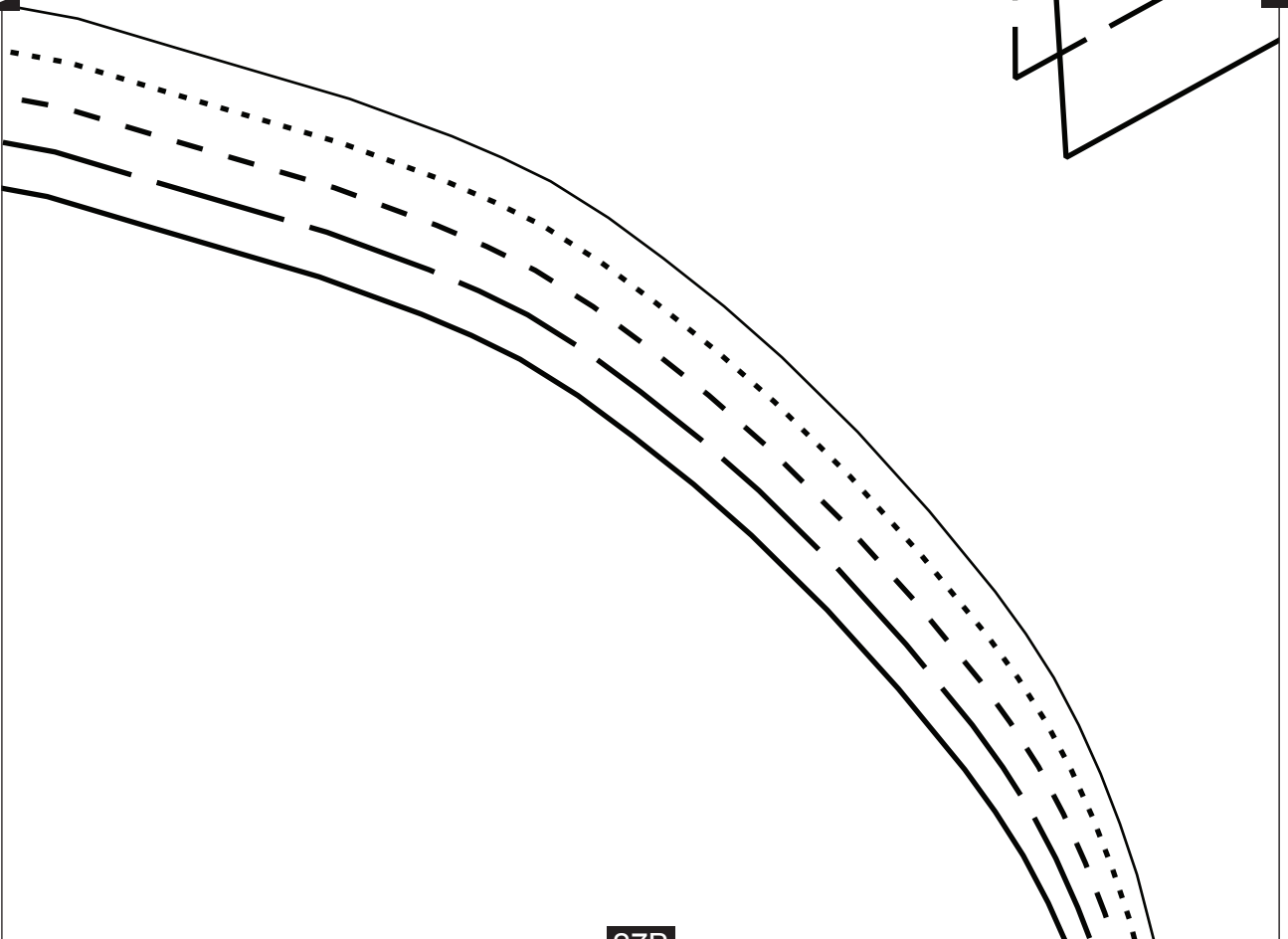

27A

27B

18B

27A

28A

28B

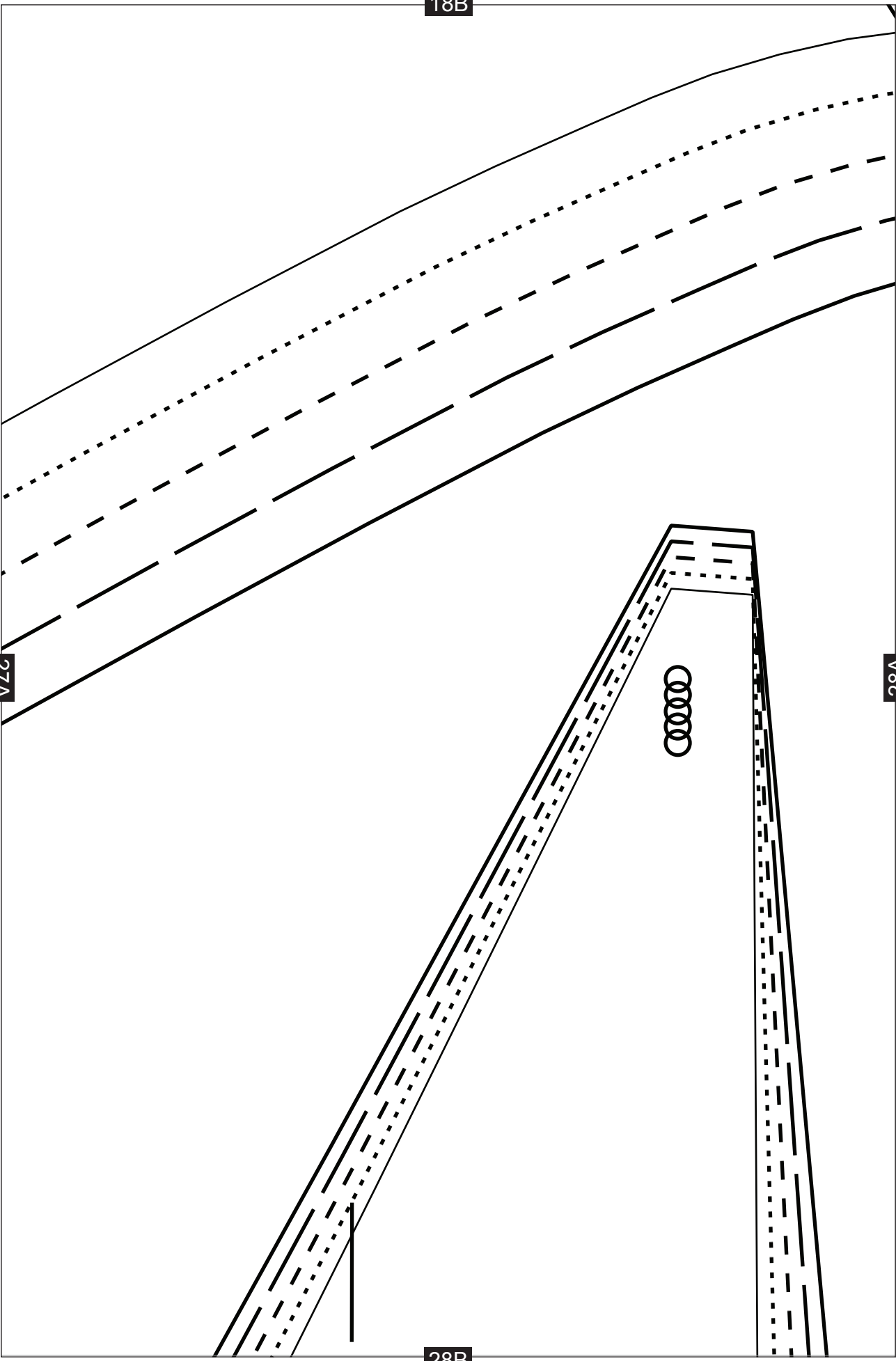

19B

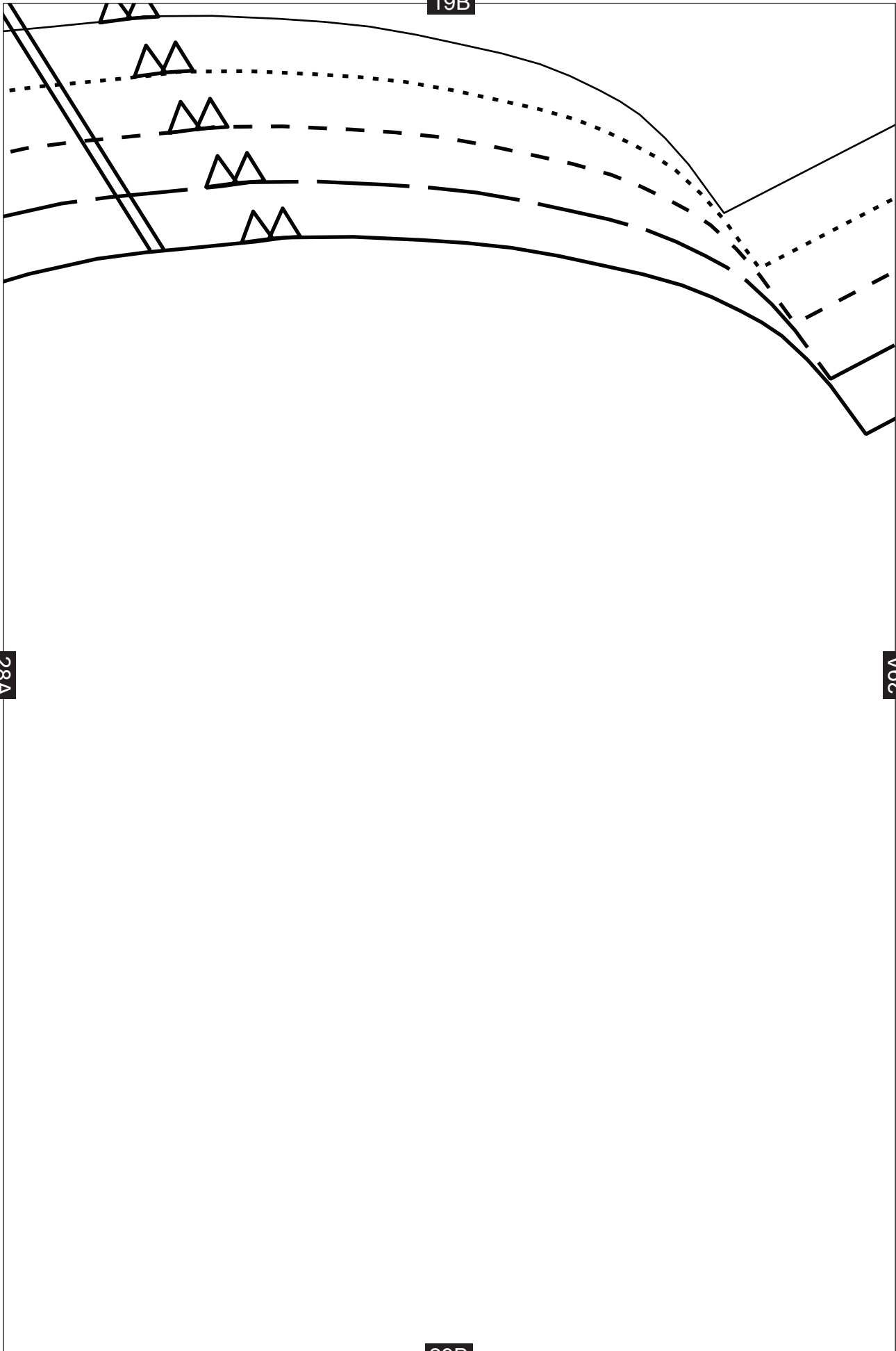

28A

29A

29B

20B

29A

30B

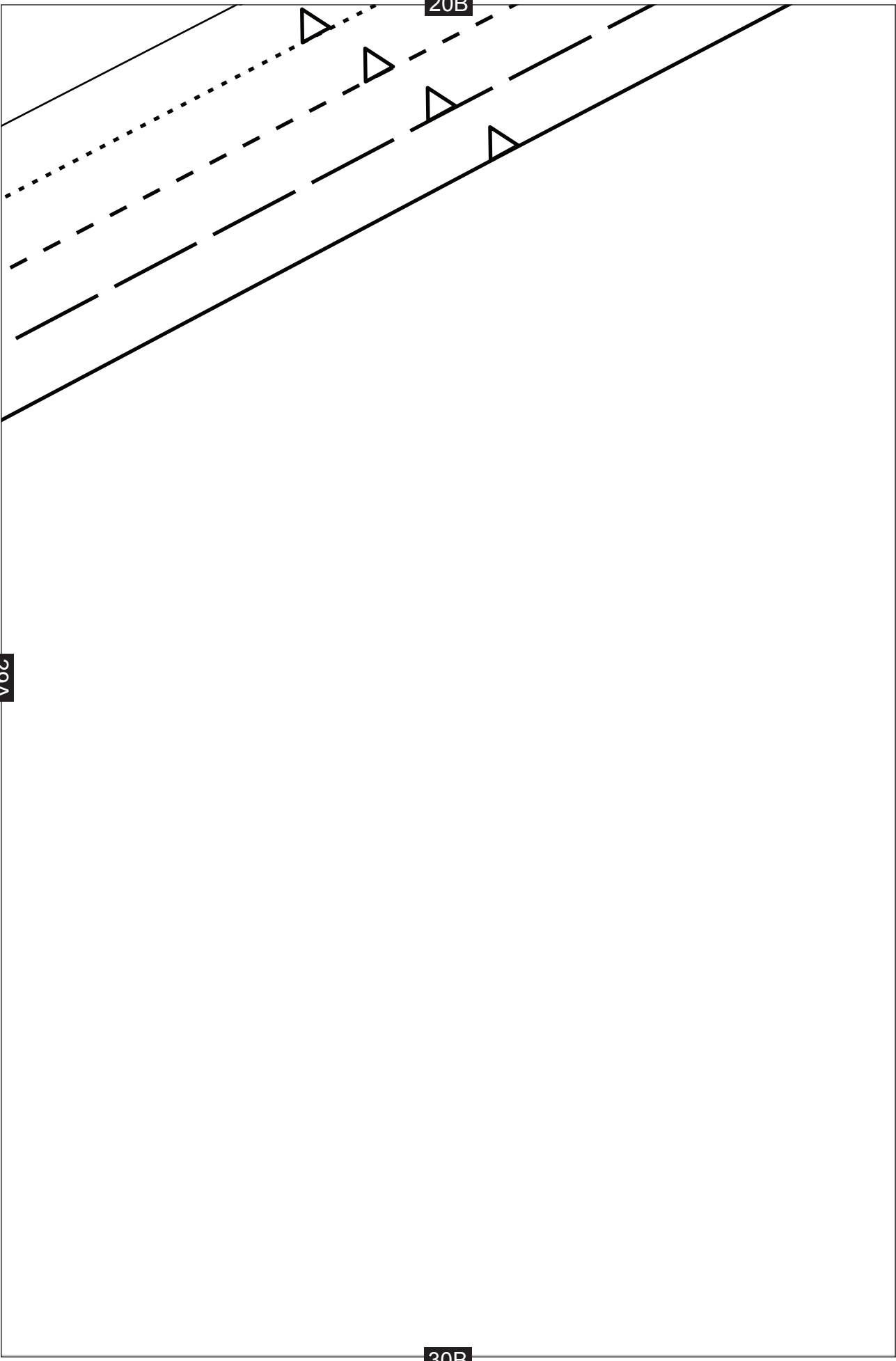

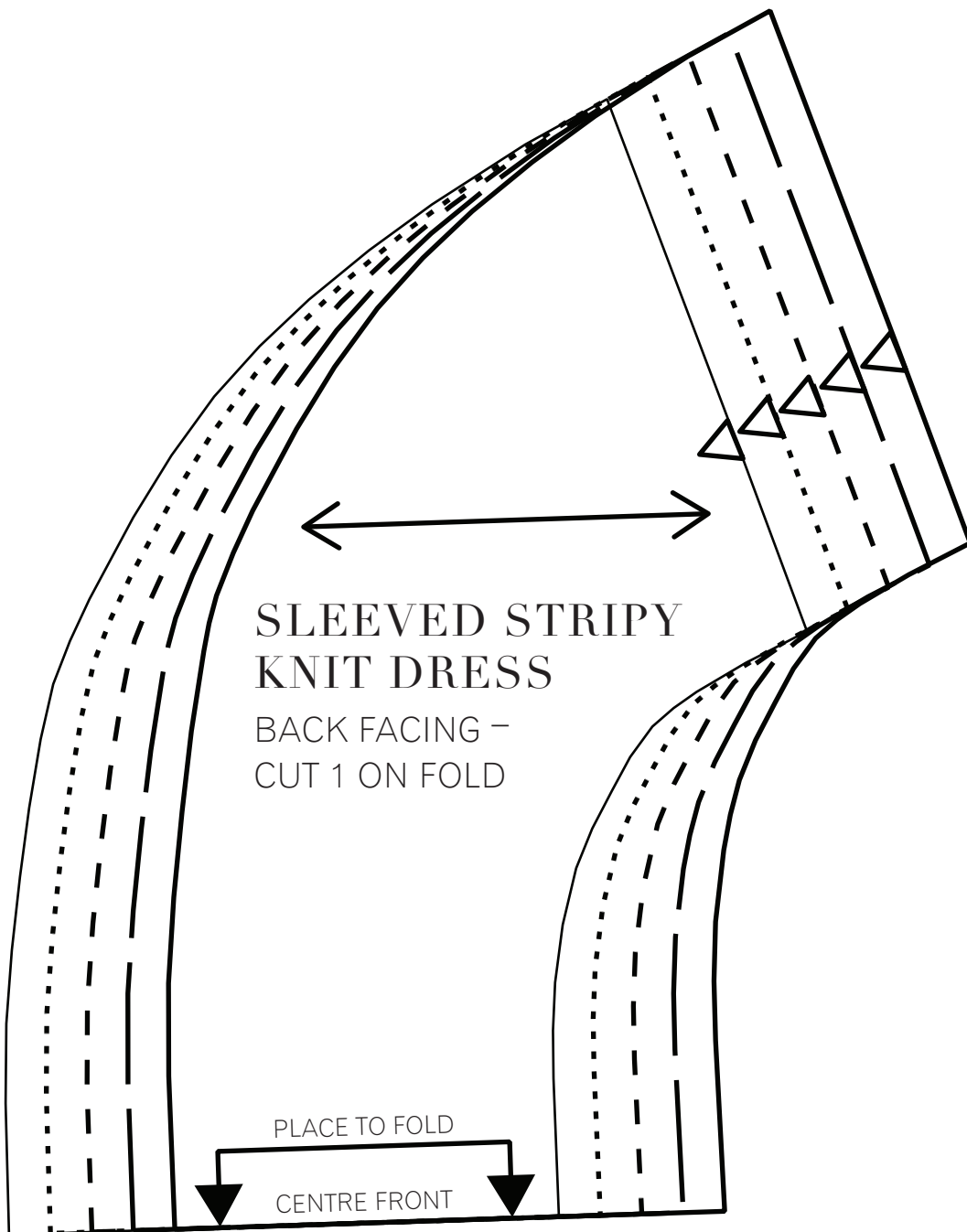

**SLEEVED STRIPY
KNOT DRESS**

BACK FACING -
CUT 1 ON FOLD

PLACE TO FOLD

CENTRE FRONT

22B

31A

32A

32B

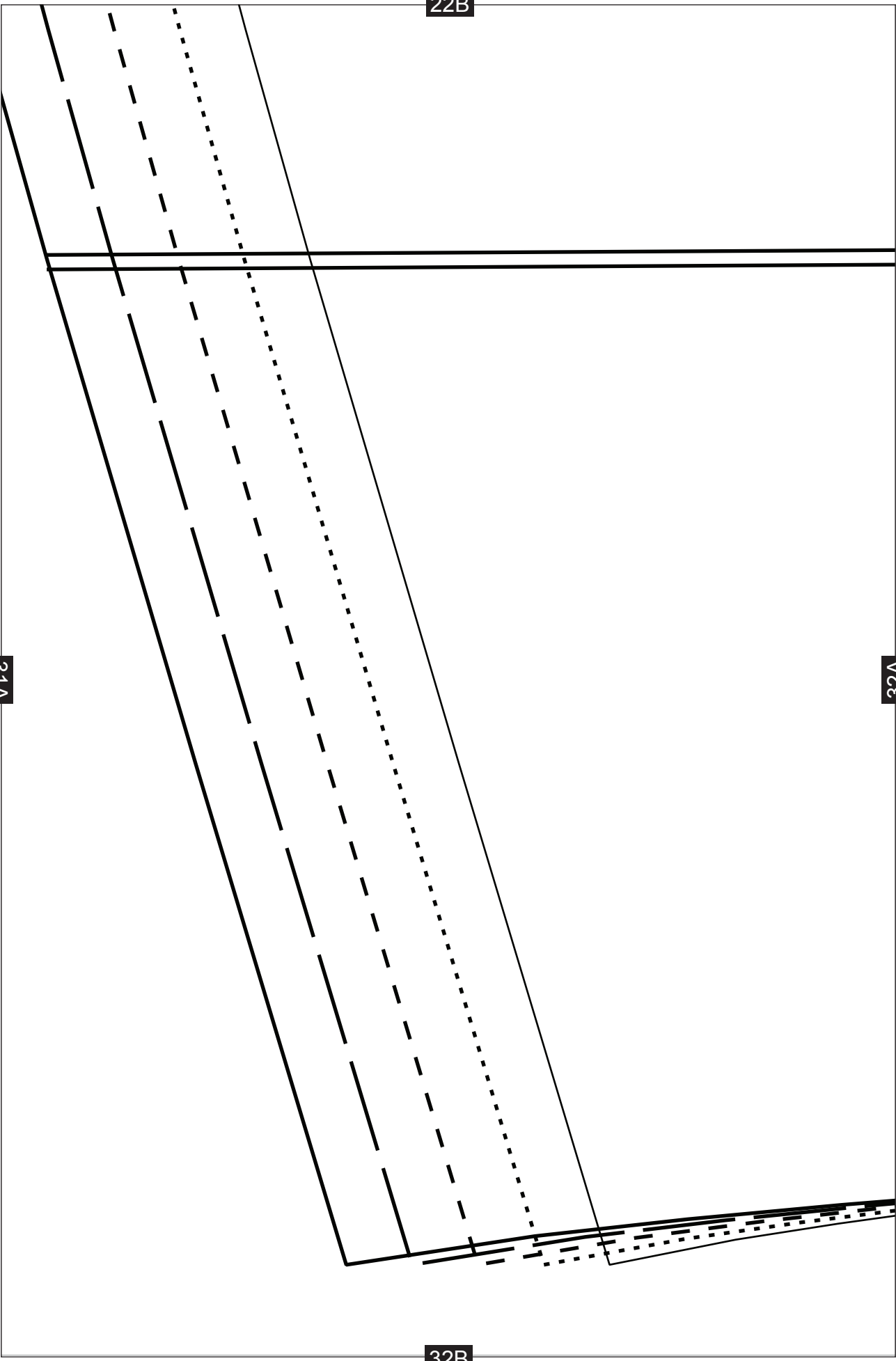

23B

SHORTEN OR LENGTHEN HERE

32A

33A

2.5-CM (1-IN) HEM INCLUDED

33B

24B

STRETCH

33A

34A

XS

S

M

L

XL

34B

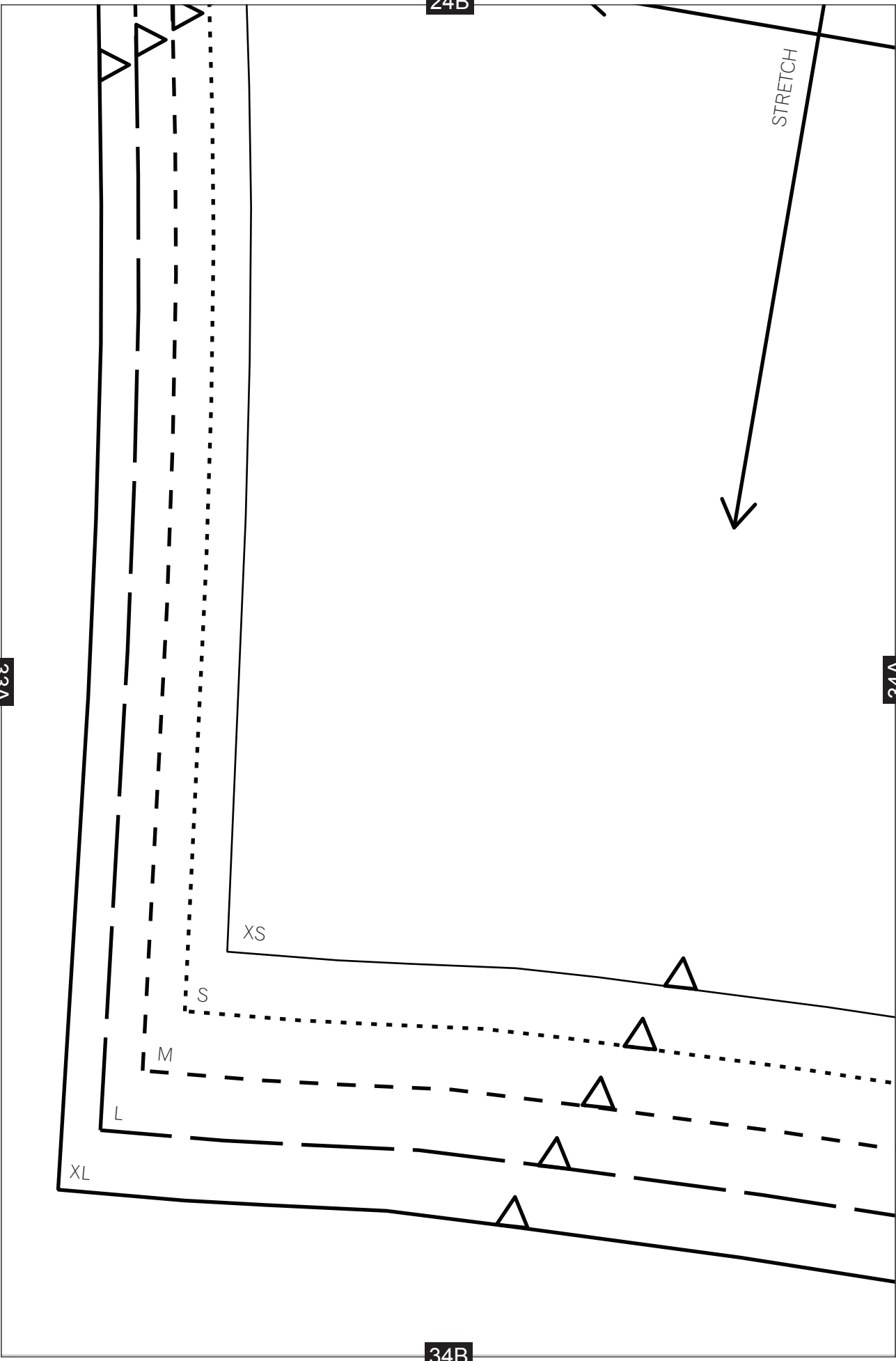

25B

GRAINLINE



34A

35A

35B

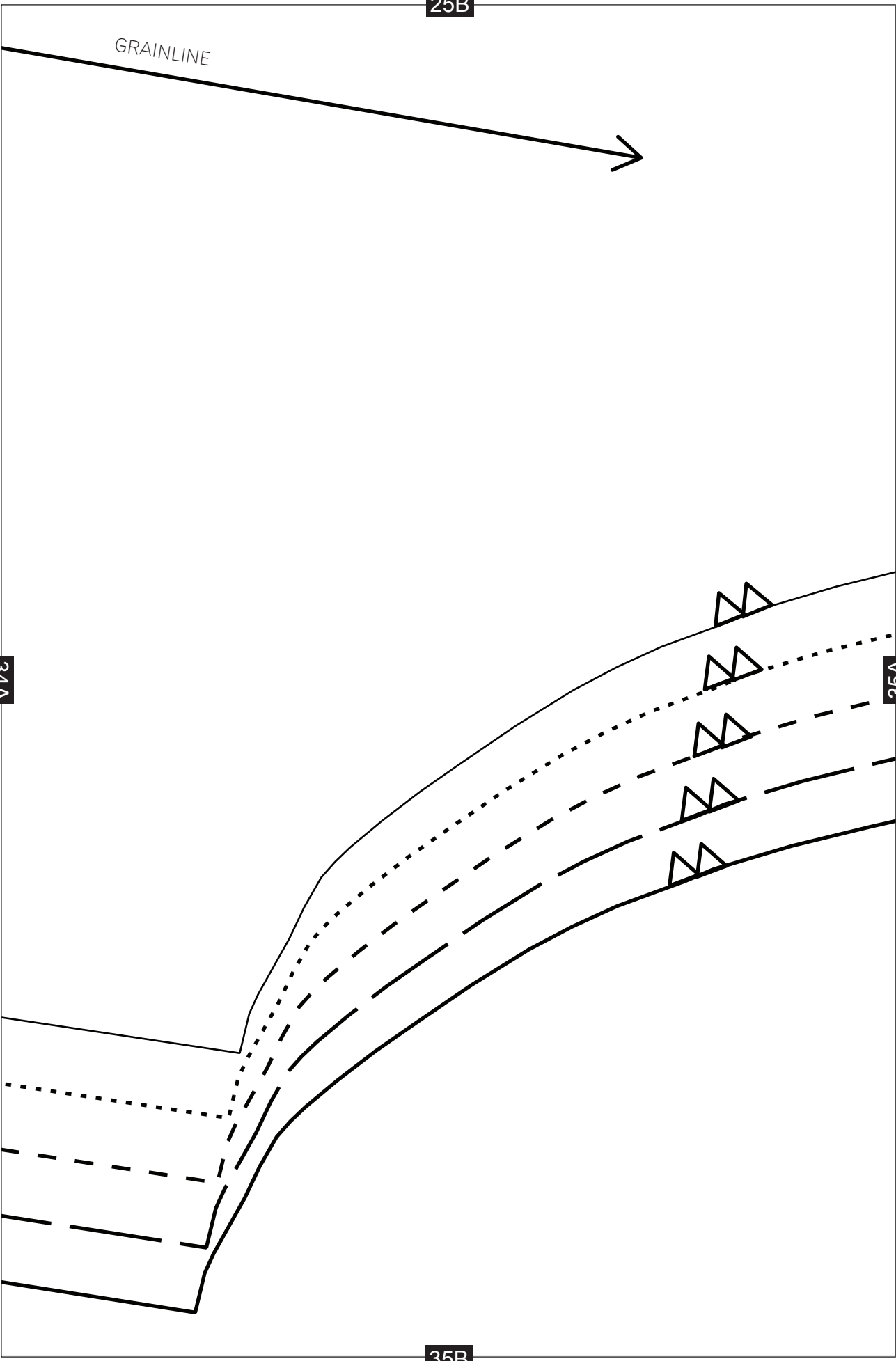

26B

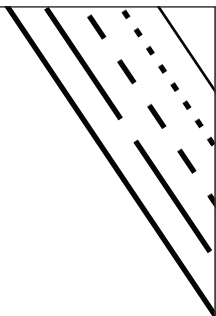

35A

36A

36B

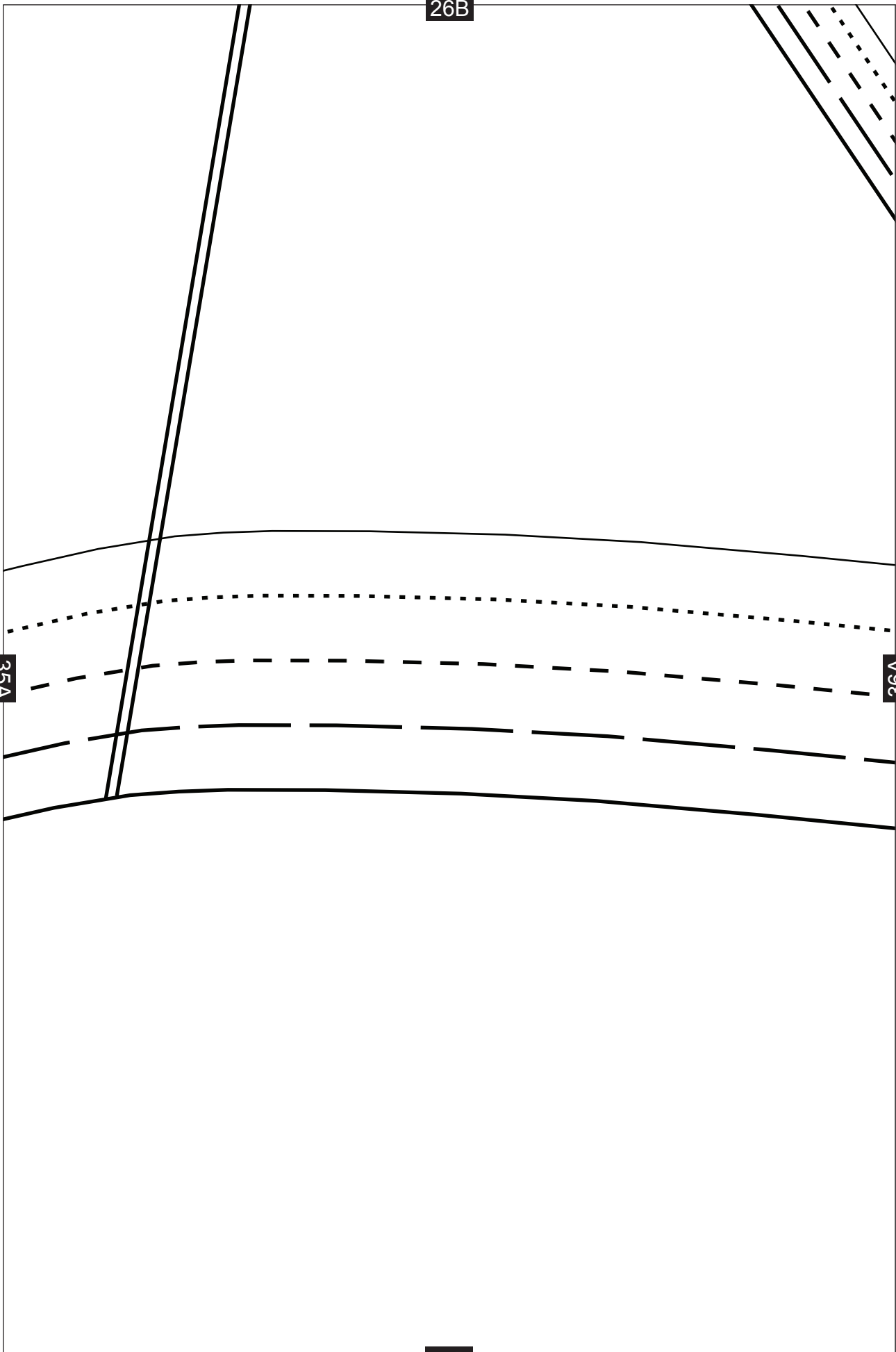

27B

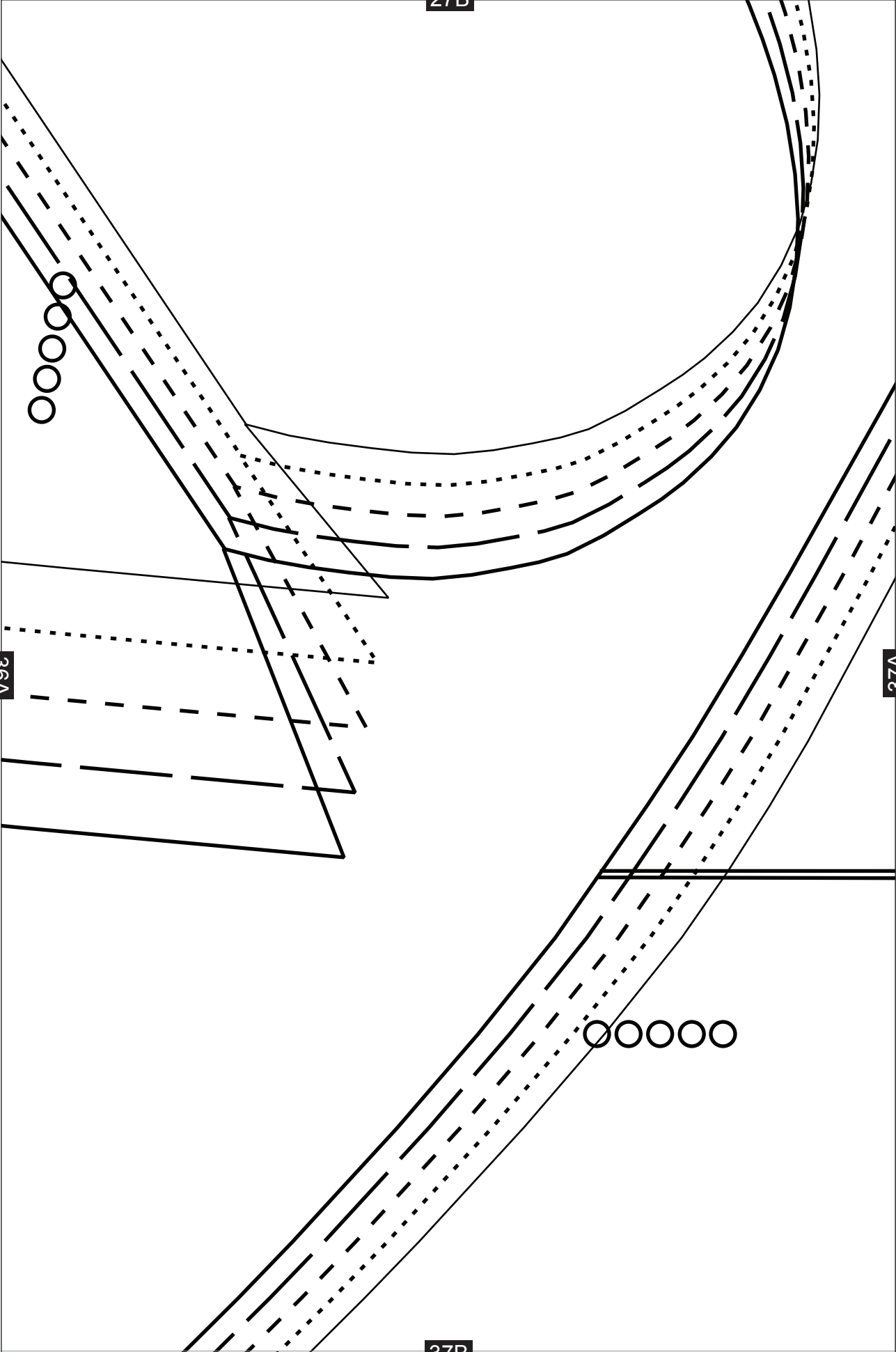

36A

37A

37B

28B

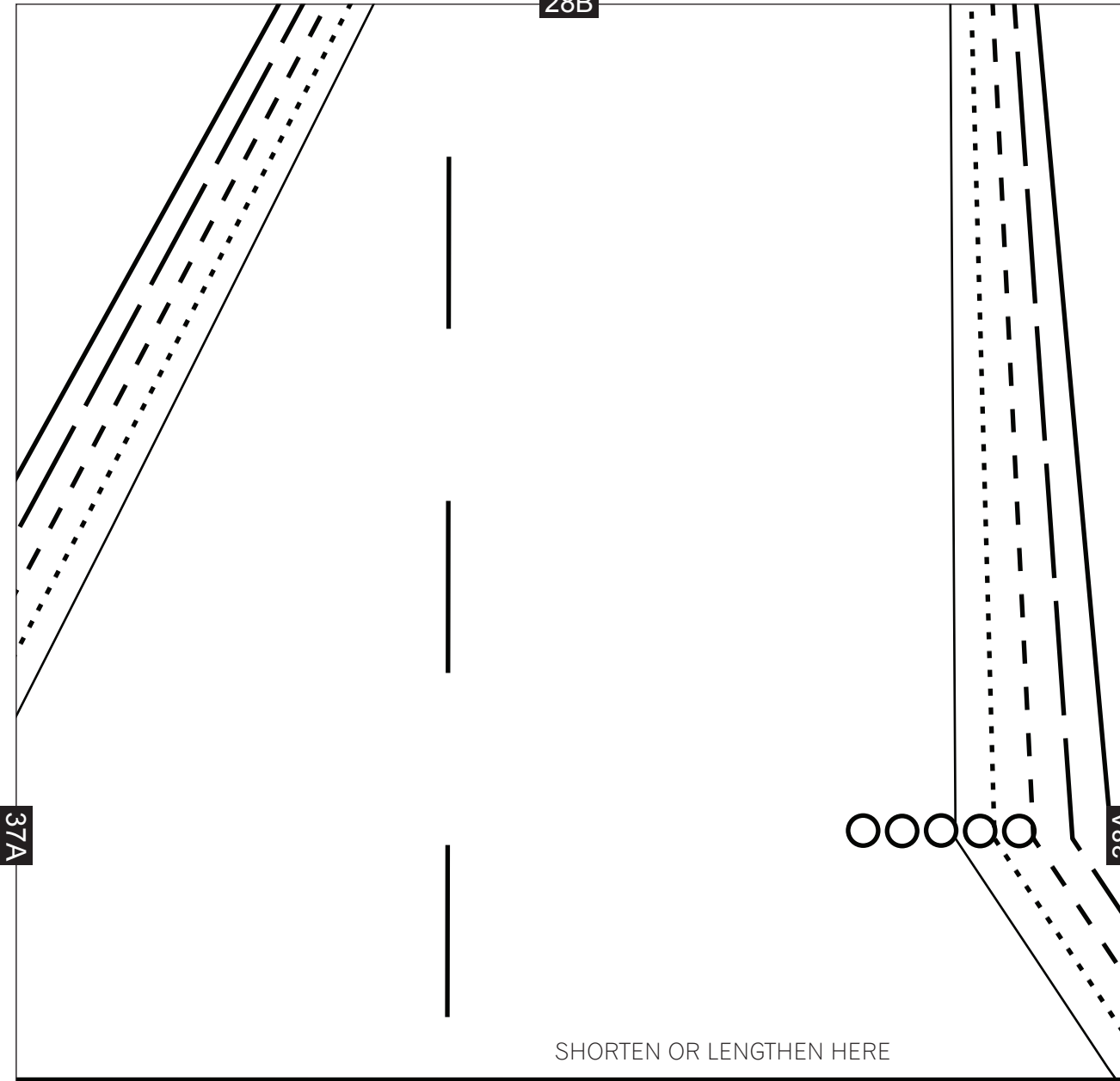

38B

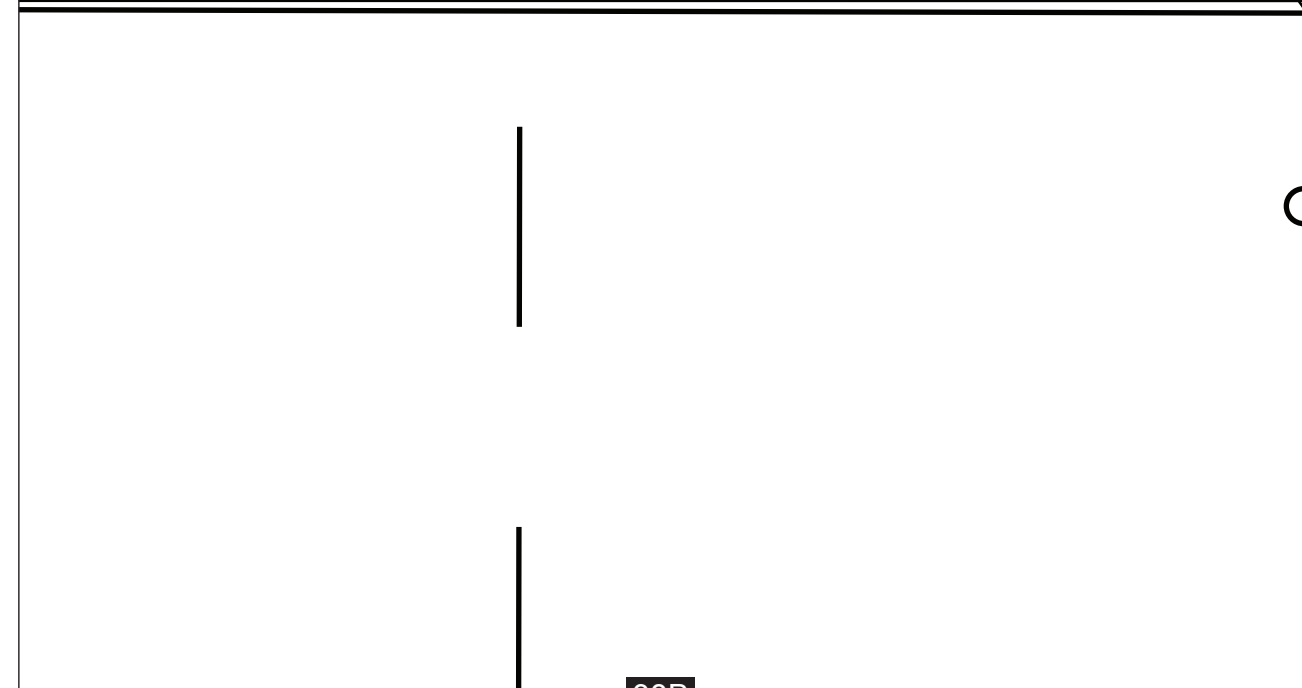

29B

38A

39A

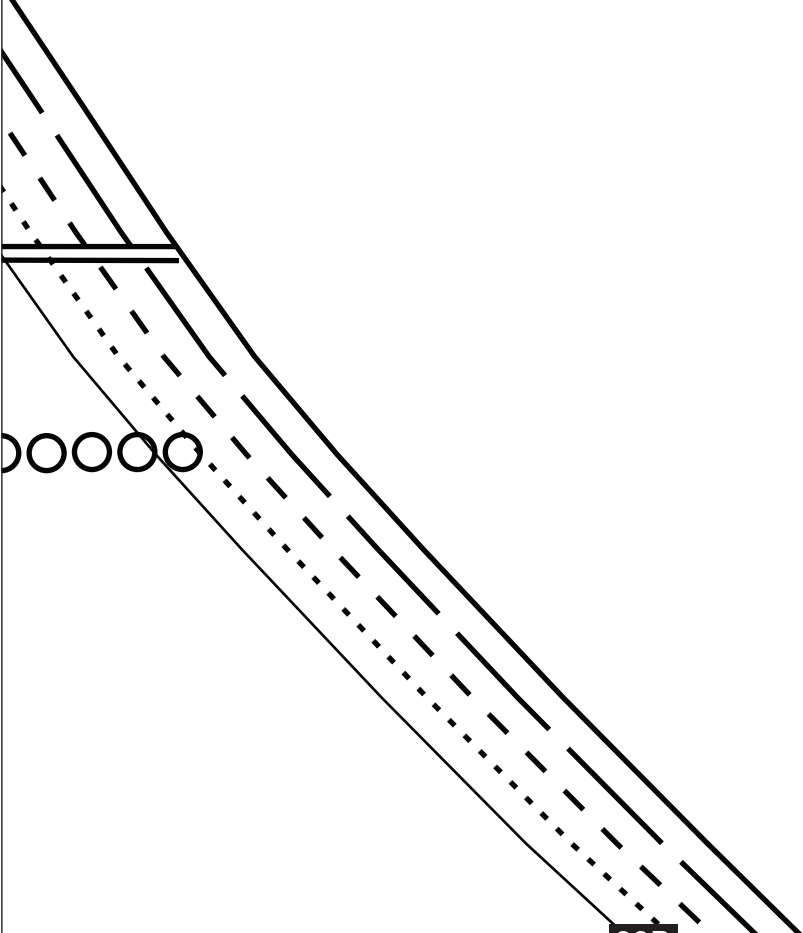

39B

30B

39A

40B

36B

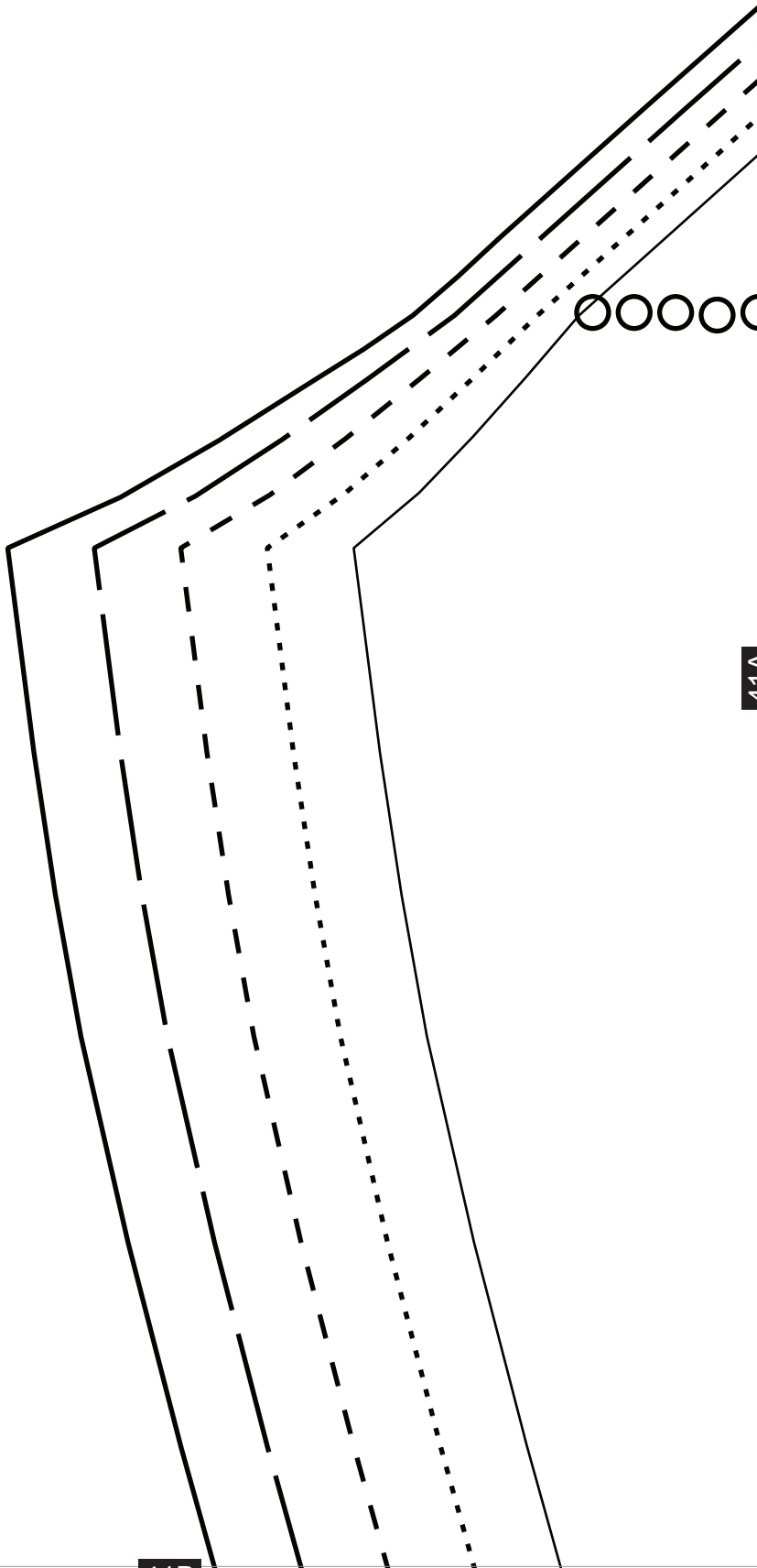

41A

41B

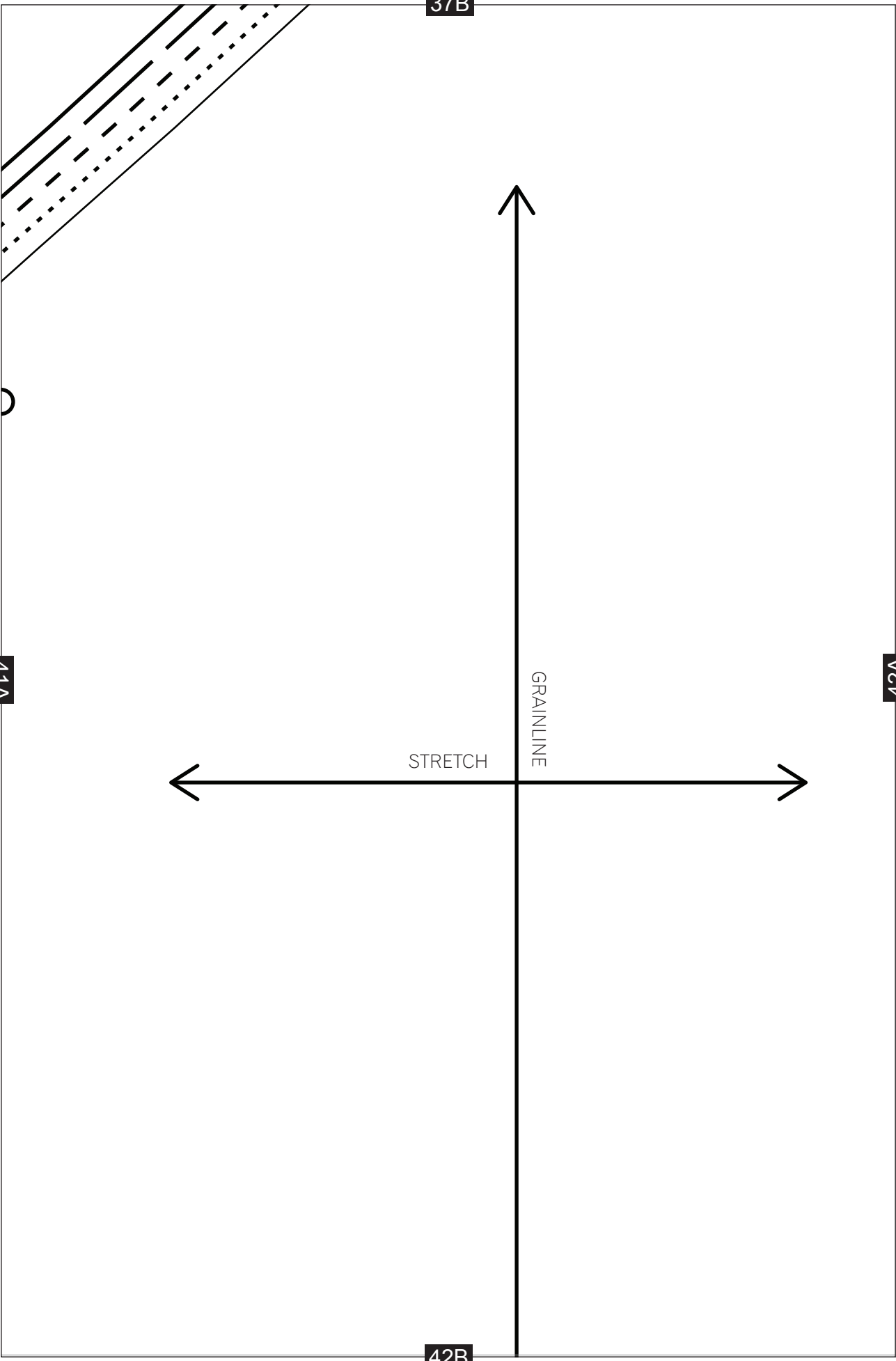

38B

42A

43A

43B

39B

POCKET OPENING



43A

44A

SLEEVED STRIPY KNIT DRESS

FRONT CENTRE - CUT 1

44B

40B

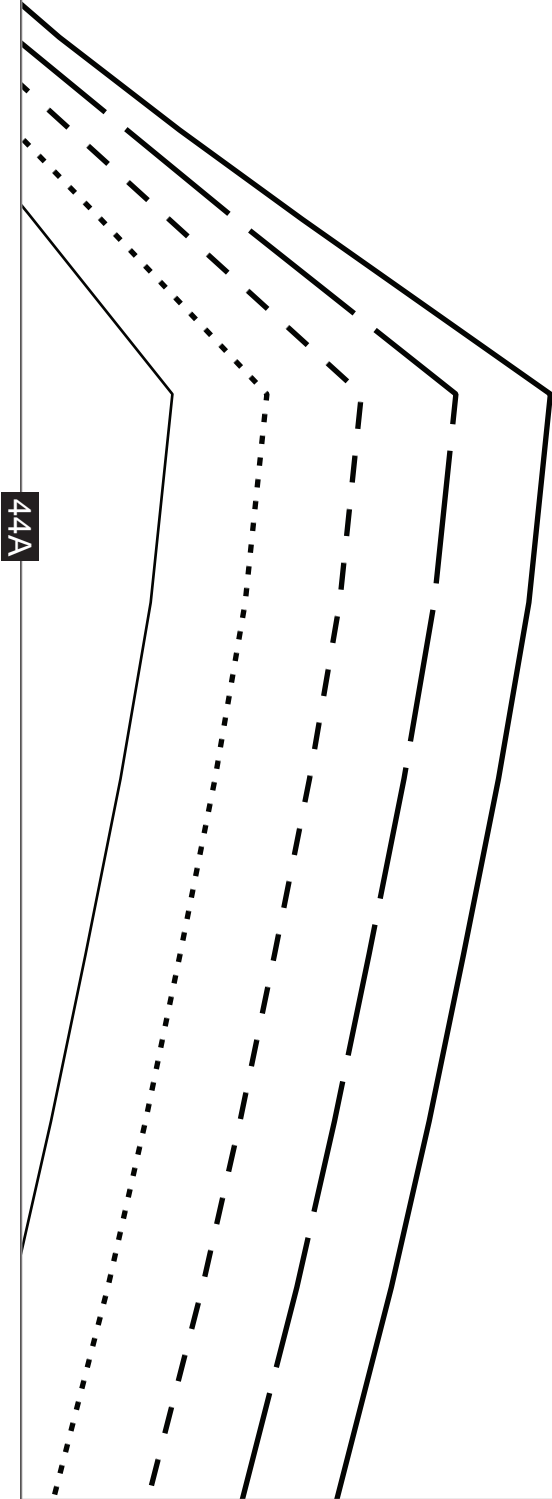

44A

45B

41B

46A

46B

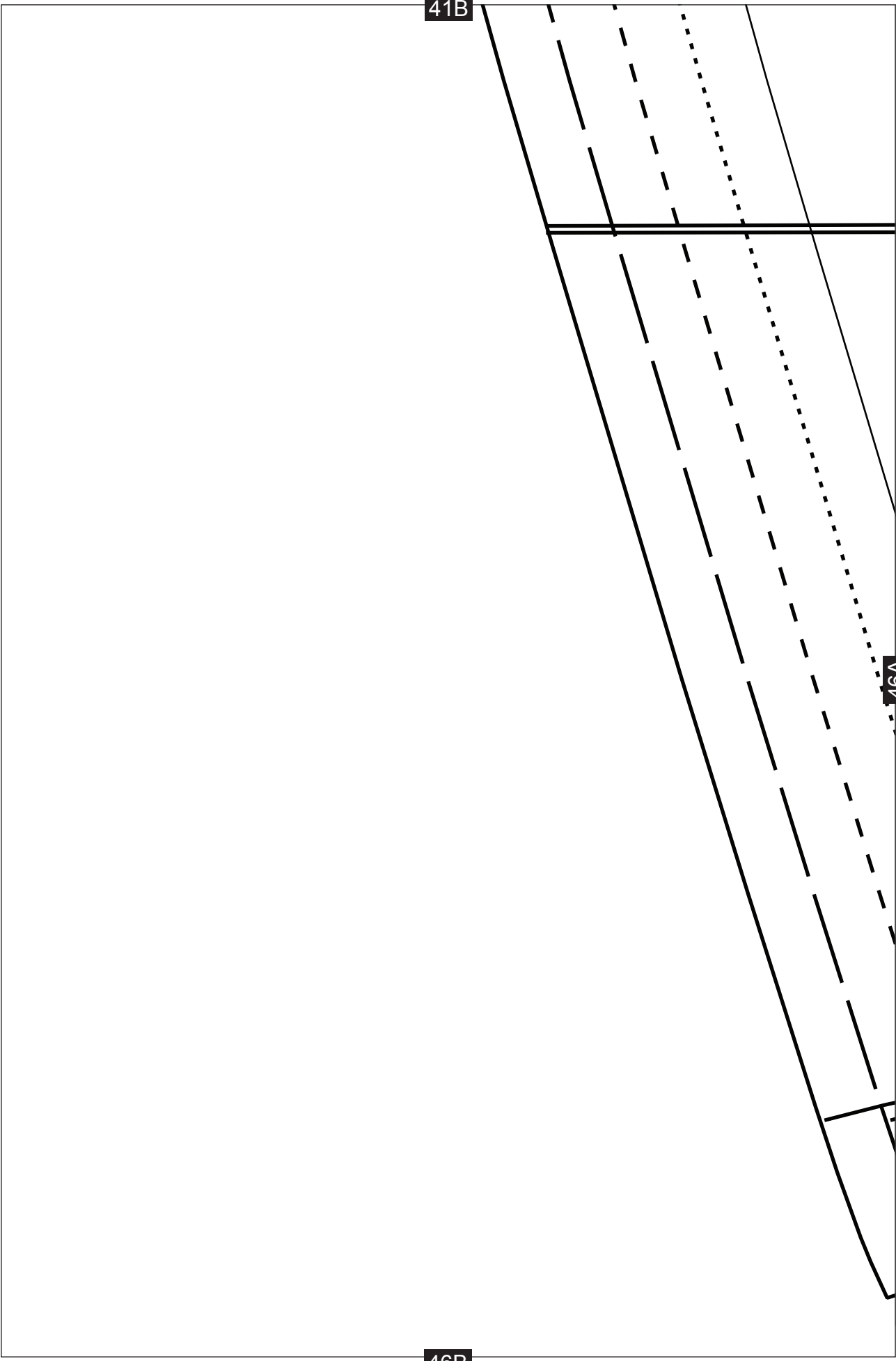

42B

46A

47A

47B

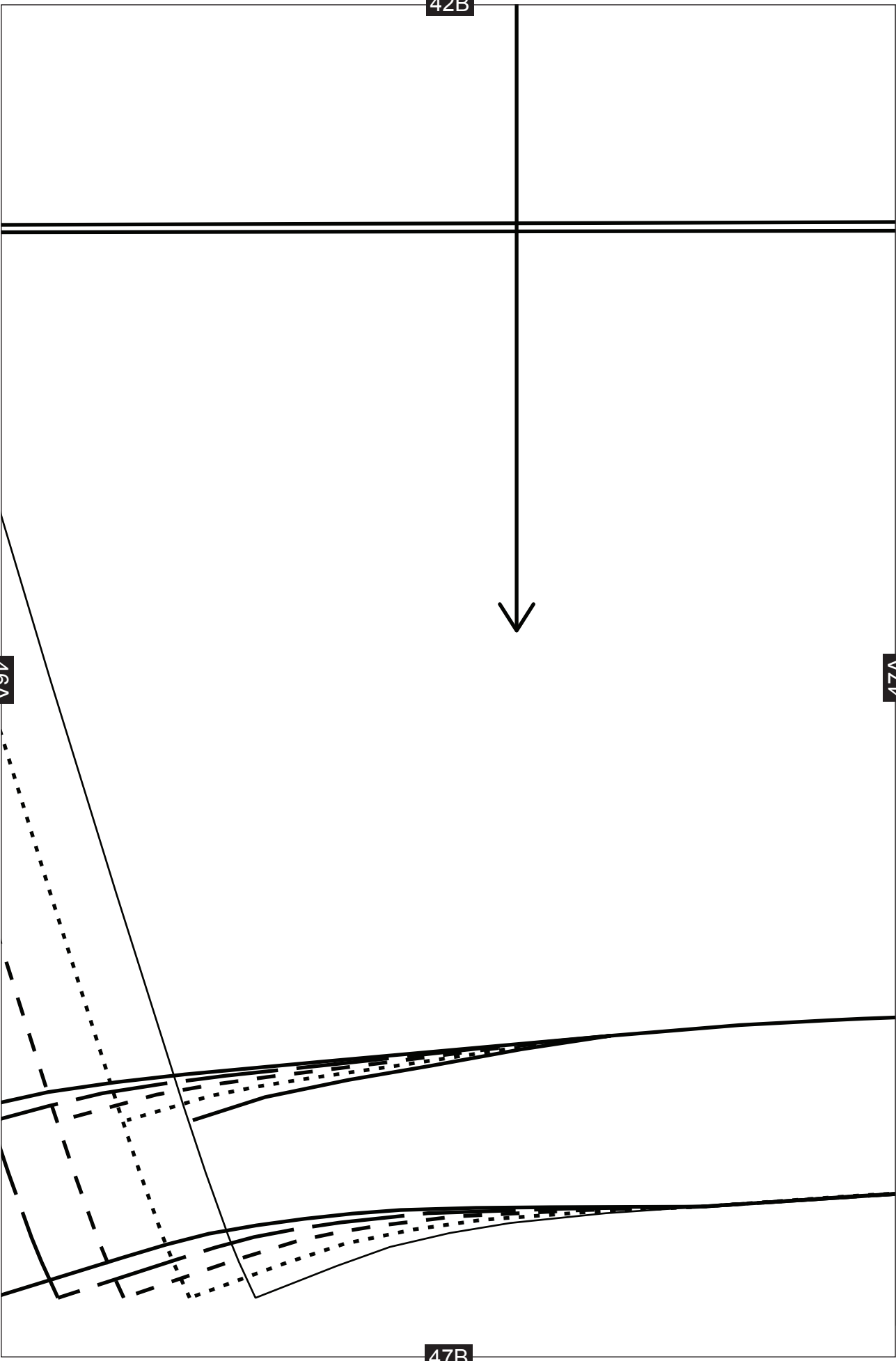

43B

SHORTEN OR LENGTHEN HERE

CENTRE FRONT LINE

47A

48A

OPTIONAL CUT LINE

48B

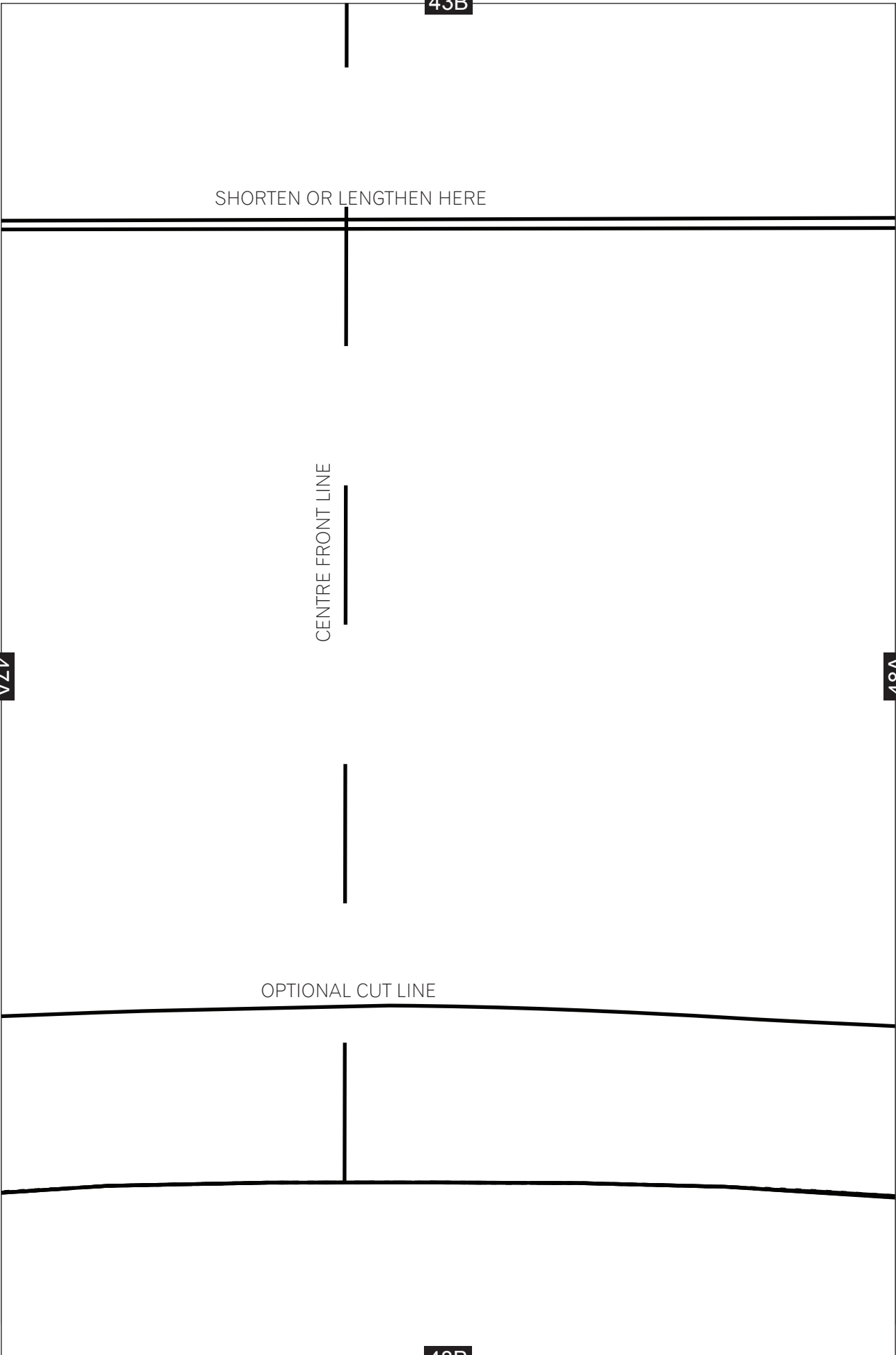

44B

48A

49A

49B

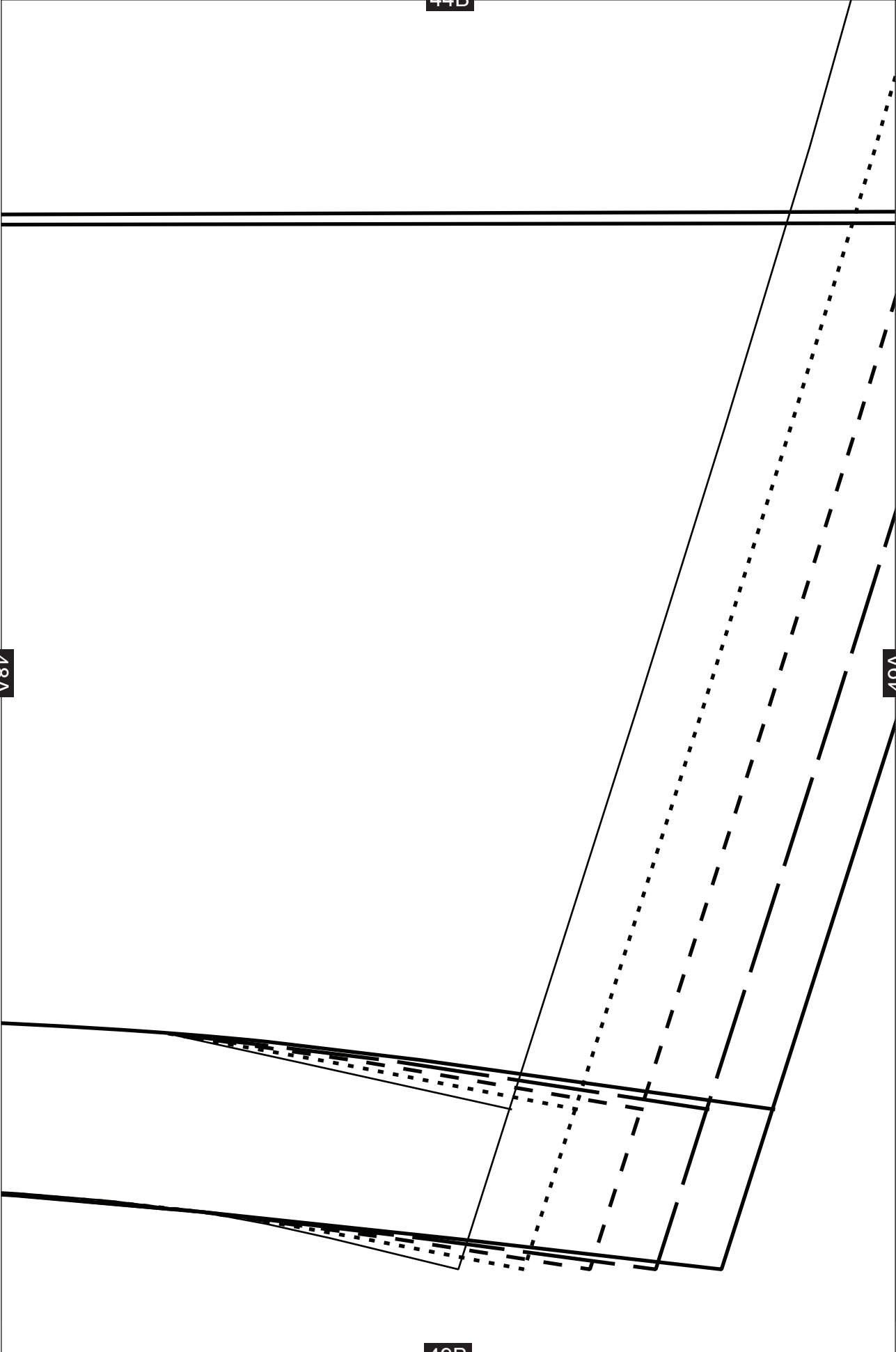

45B

49A

50B

