

DRIED FLOWER EMBROIDERY

BY OLGA PRINKU

TYPOGRAPHY

Print at 100%, cut along the dashed lined
and piece together with the second sheet

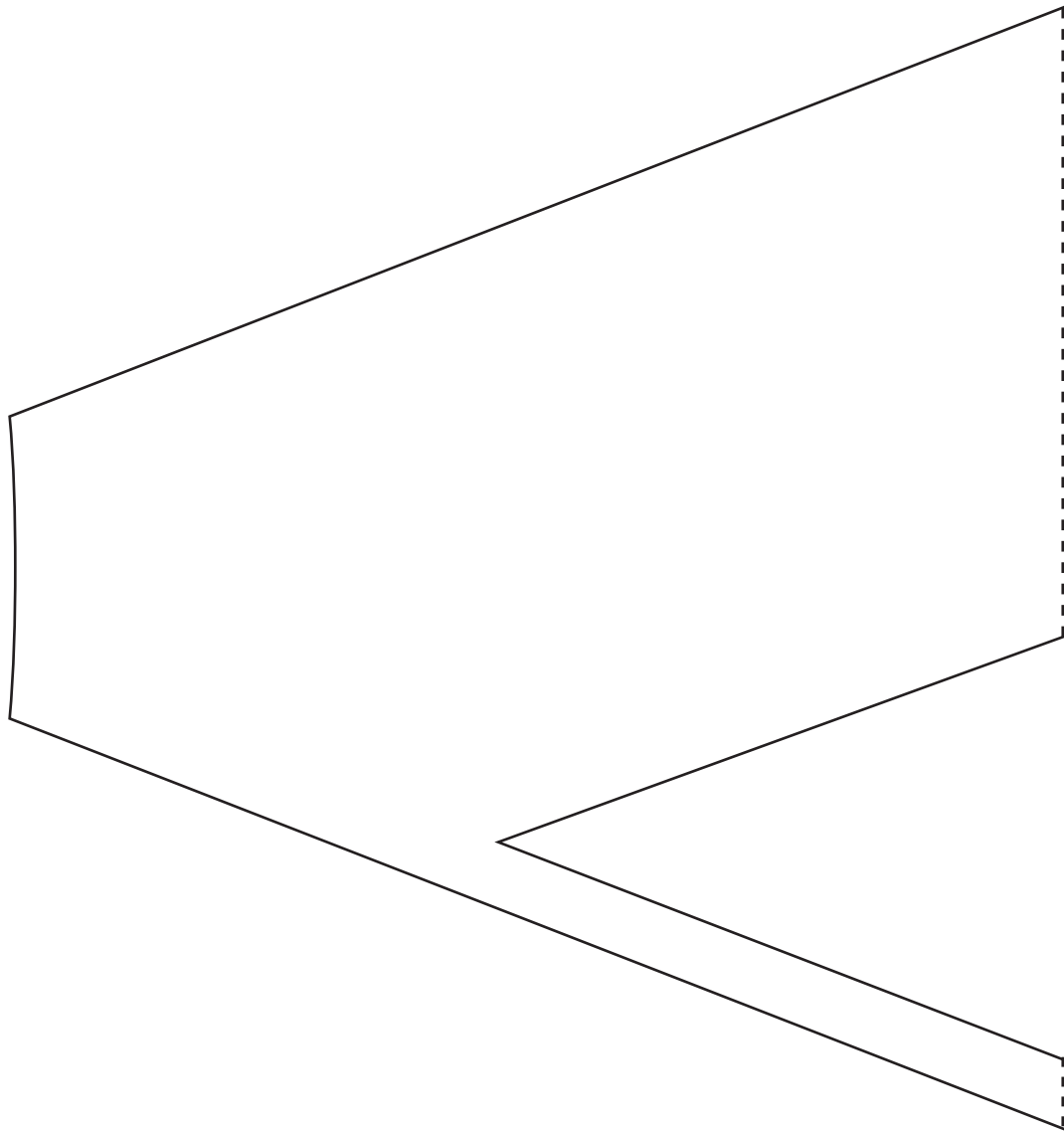

DRIED FLOWER EMBROIDERY

BY OLGA PRINKU

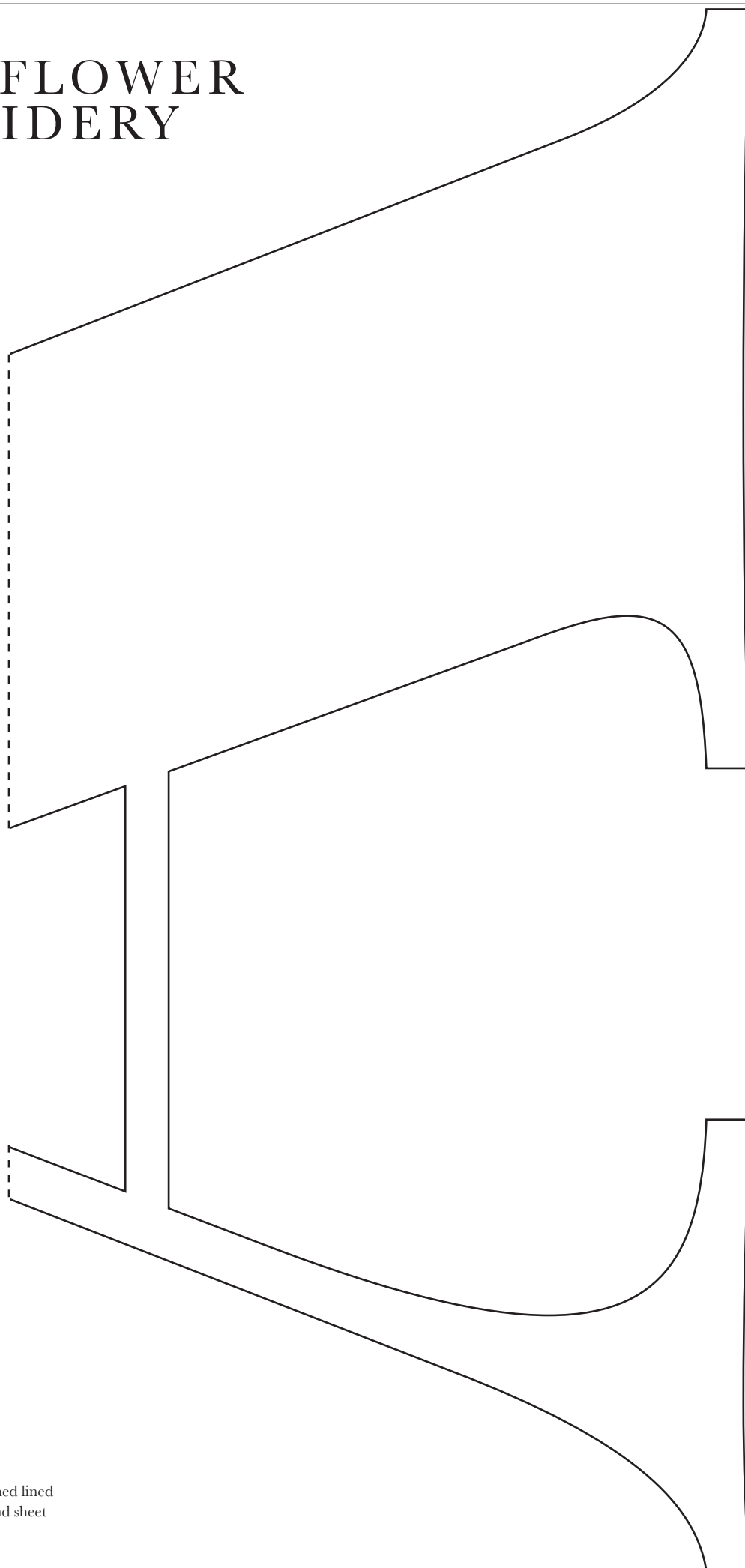

TYPOGRAPHY

Print at 100%, cut along the dashed lined
and piece together with the second sheet

DRIED FLOWER EMBROIDERY

BY OLGA PRINKU

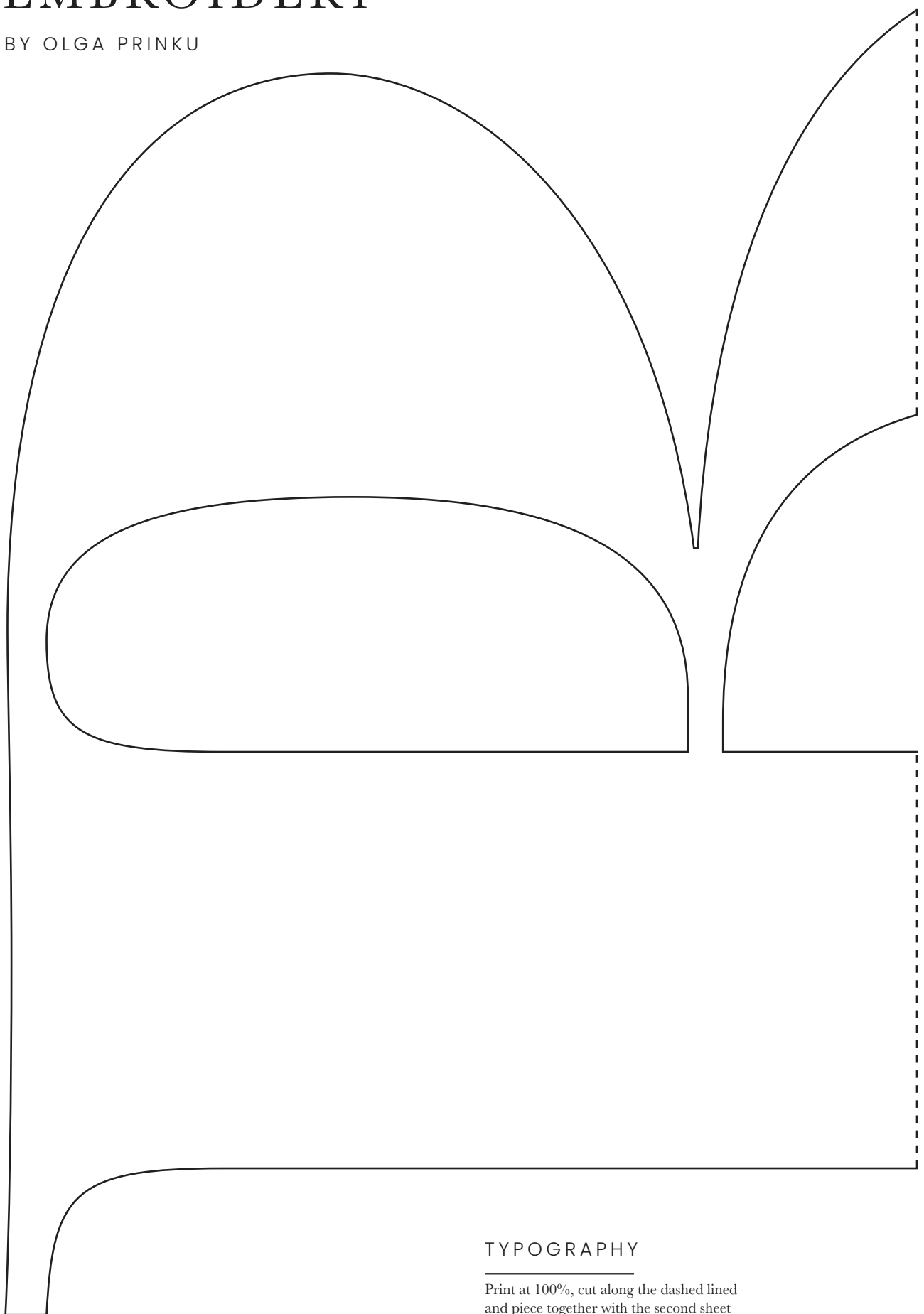

TYPOGRAPHY

Print at 100%, cut along the dashed lined
and piece together with the second sheet

DRIED FLOWER EMBROIDERY

BY OLGA PRINKU

TYPOGRAPHY

Print at 100%, cut along the dashed lined
and piece together with the second sheet

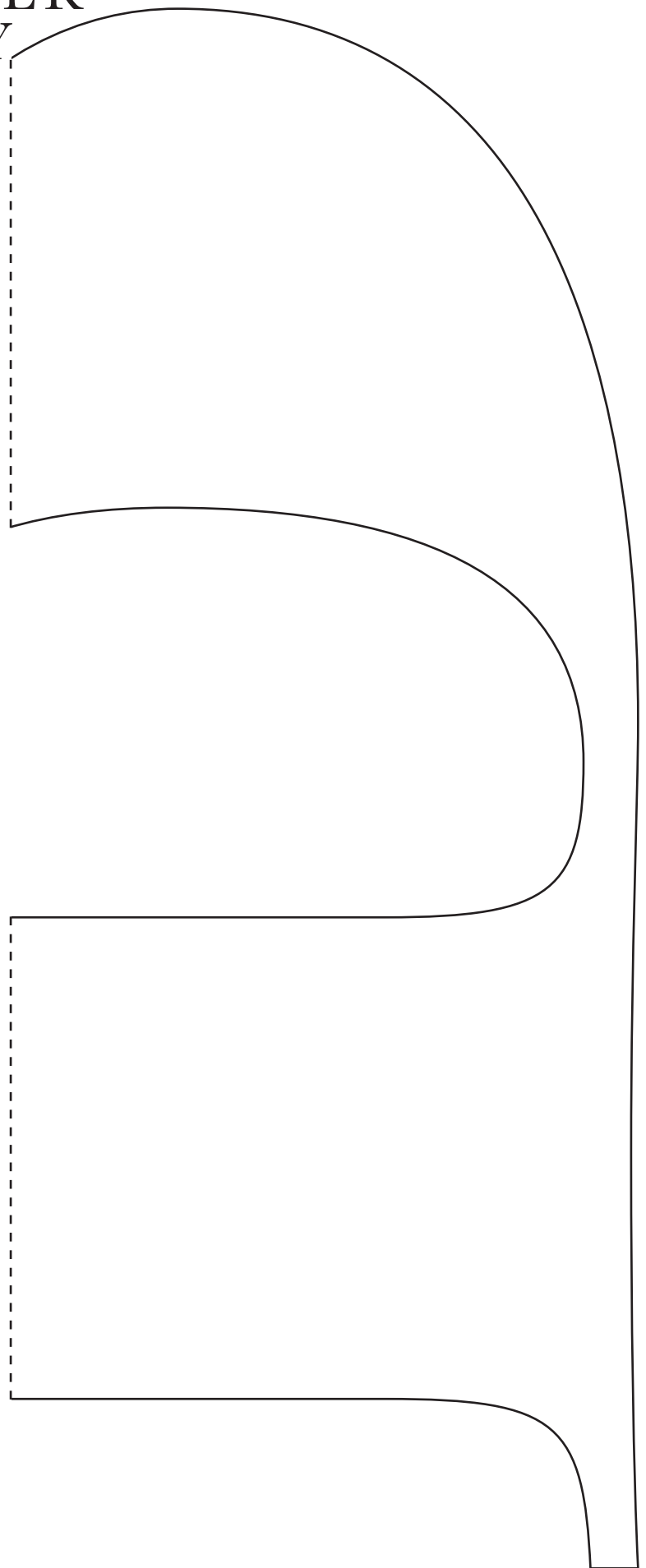

DRIED FLOWER EMBROIDERY

BY OLGA PRINKU

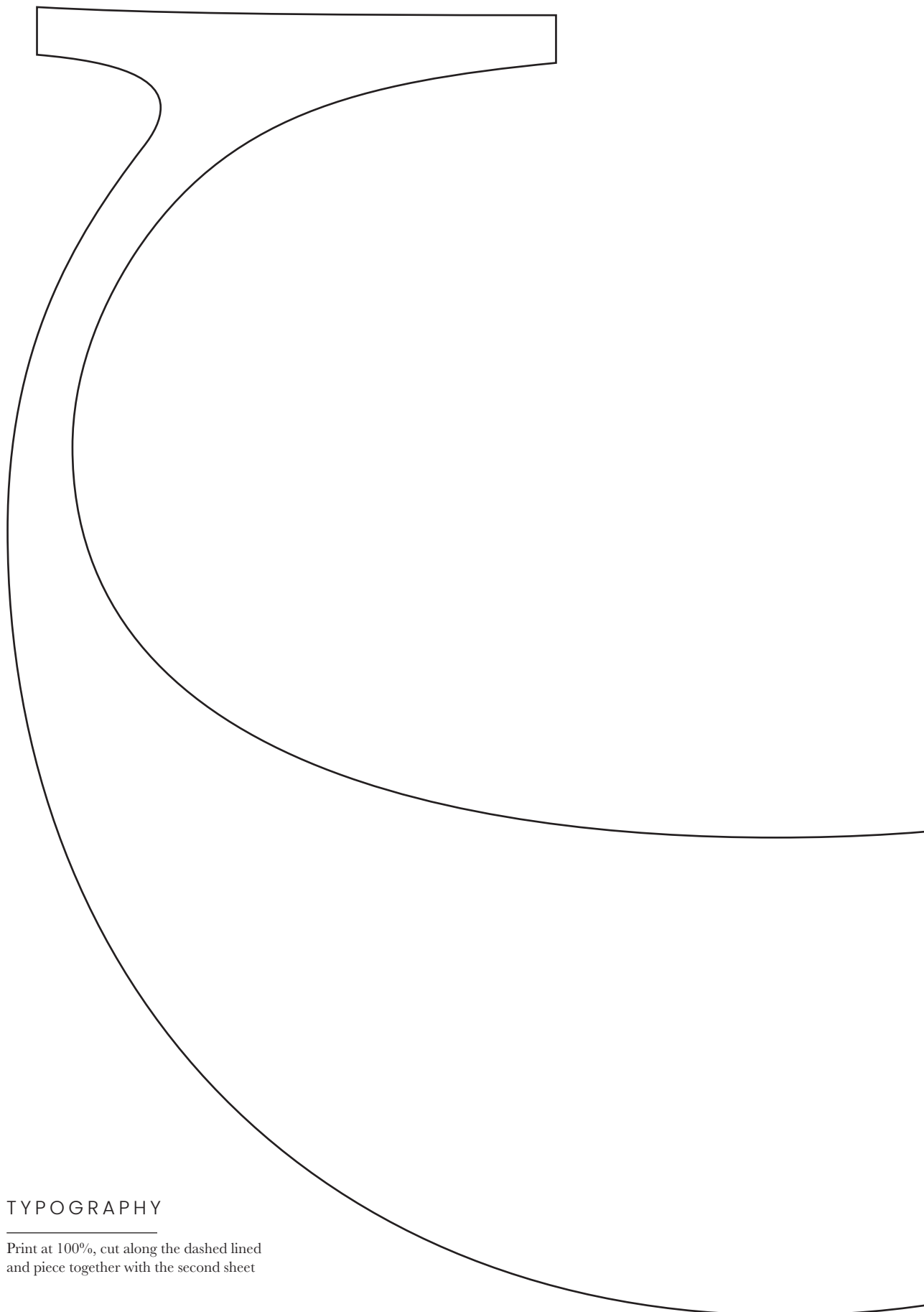

TYPOGRAPHY

Print at 100%, cut along the dashed lined
and piece together with the second sheet

DRIED FLOWER EMBROIDERY

BY OLGA PRINKU

TYPOGRAPHY

Print at 100%, cut along the dashed lined
and piece together with the second sheet

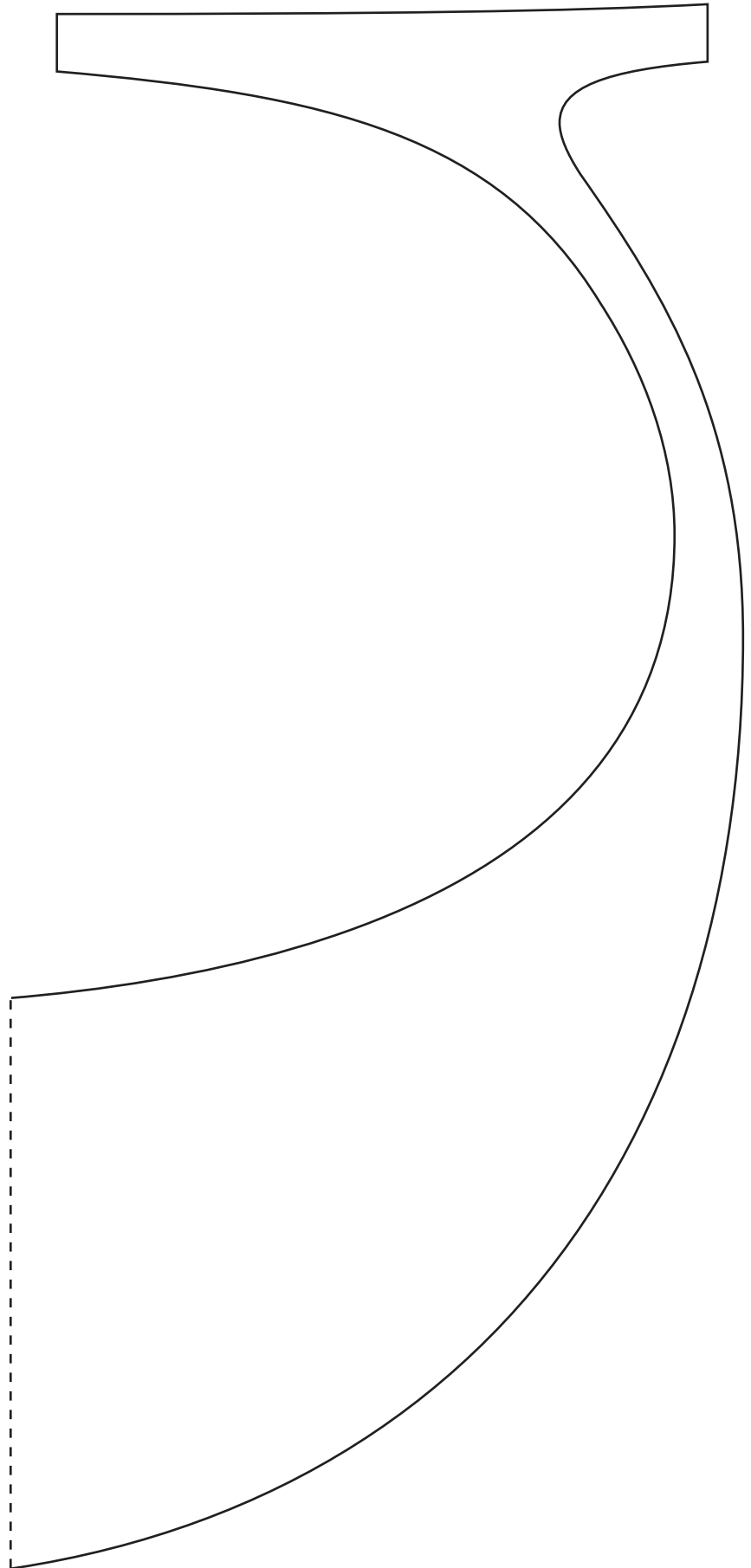

DRIED FLOWER EMBROIDERY

BY OLGA PRINKU

TYPOGRAPHY

Print at 100%, cut along the dashed lined
and piece together with the second sheet

DRIED FLOWER EMBROIDERY

BY OLGA PRINKU

TYPOGRAPHY

Print at 100%, cut along the dashed lined
and piece together with the second sheet

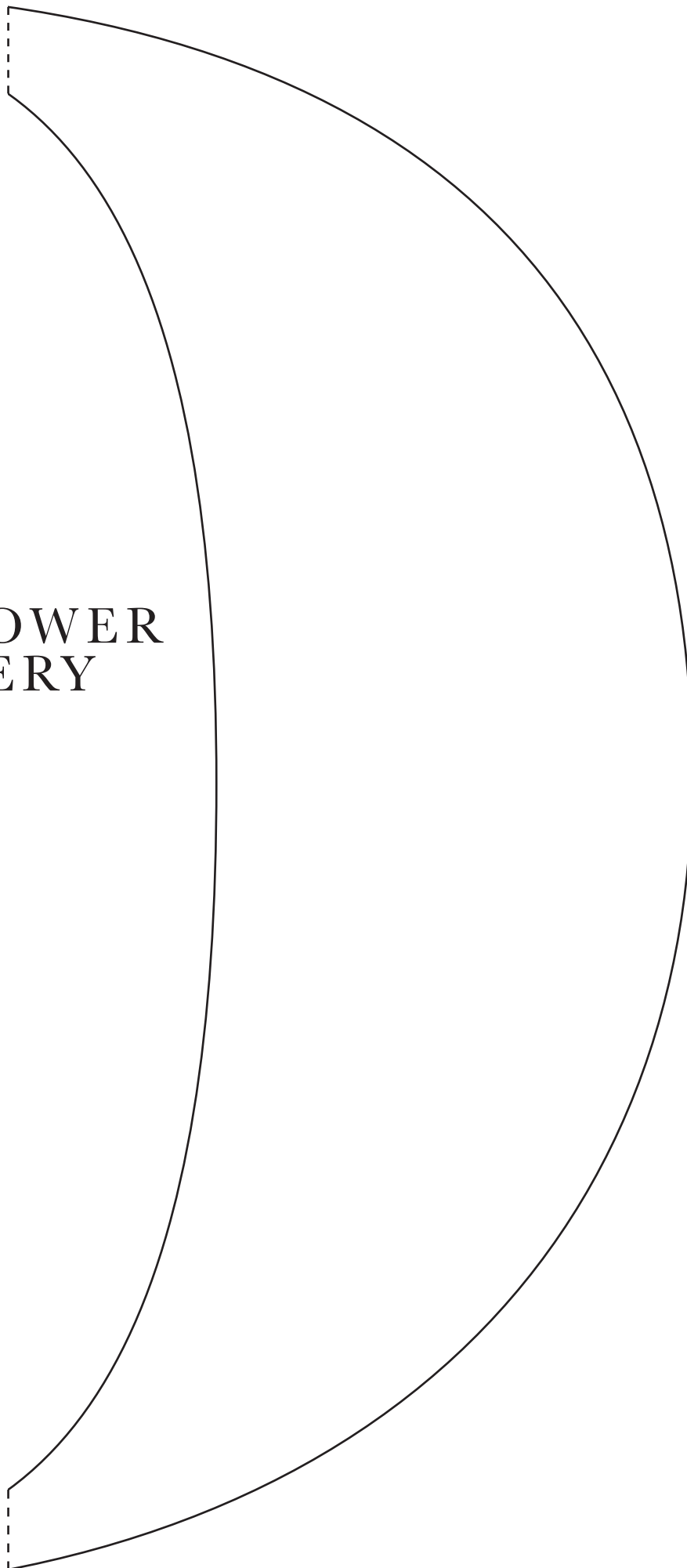

DRIED FLOWER EMBROIDERY

BY OLGA PRINKU

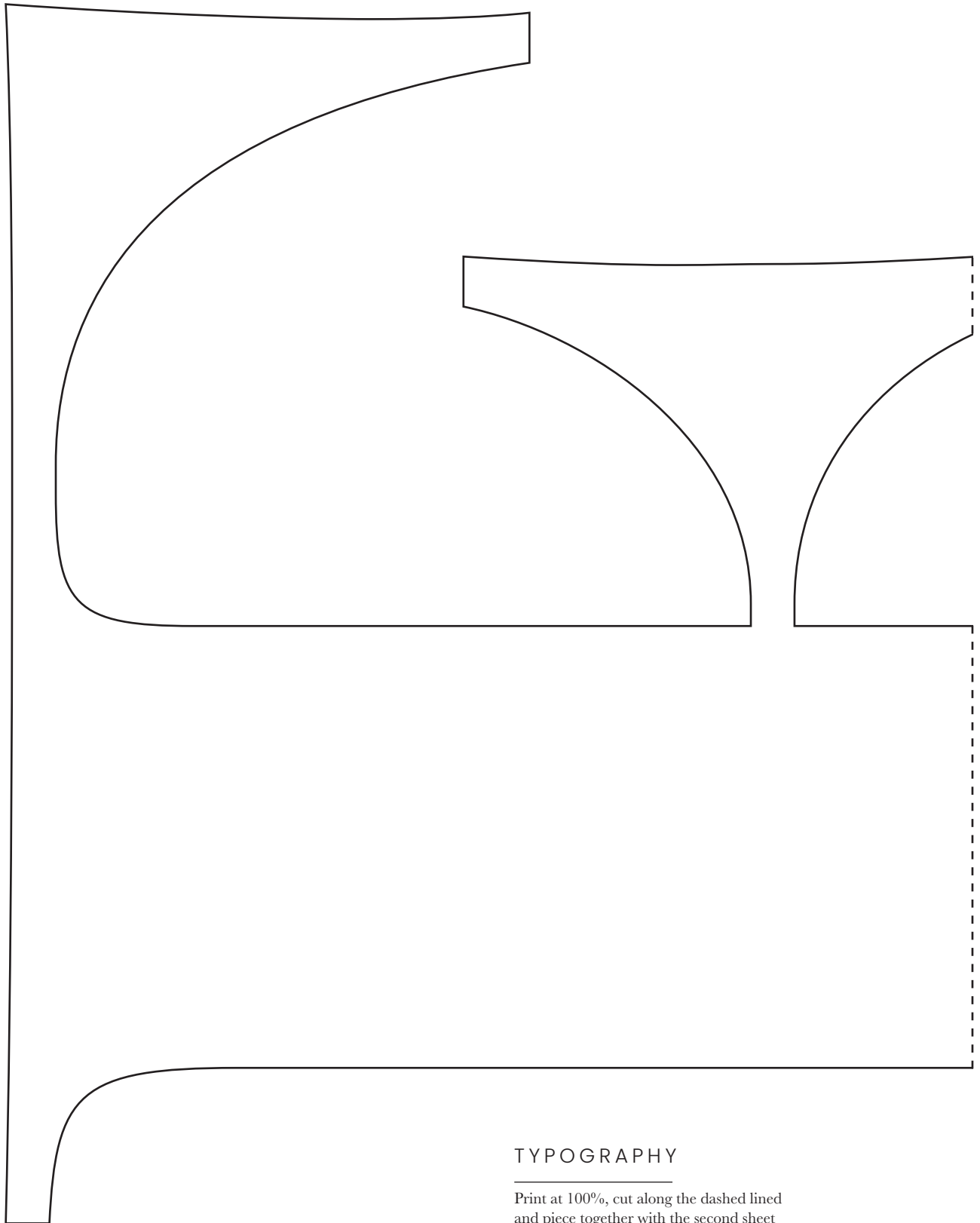

TYPOGRAPHY

Print at 100%, cut along the dashed lined
and piece together with the second sheet

DRIED FLOWER EMBROIDERY

BY OLGA PRINKU

TYPOGRAPHY

Print at 100%, cut along the dashed lined and piece together with the second sheet

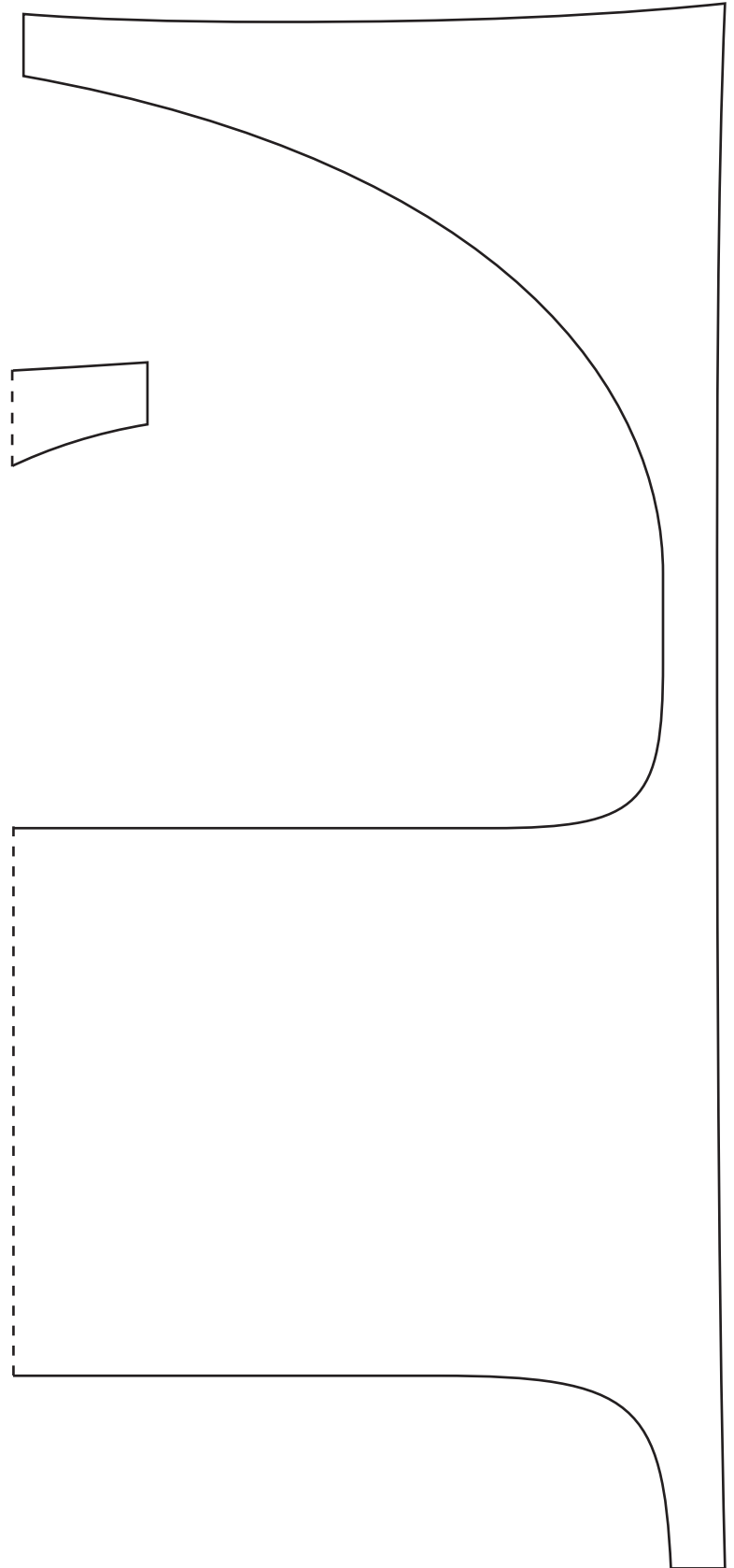

DRIED FLOWER EMBROIDERY

BY OLGA PRINKU

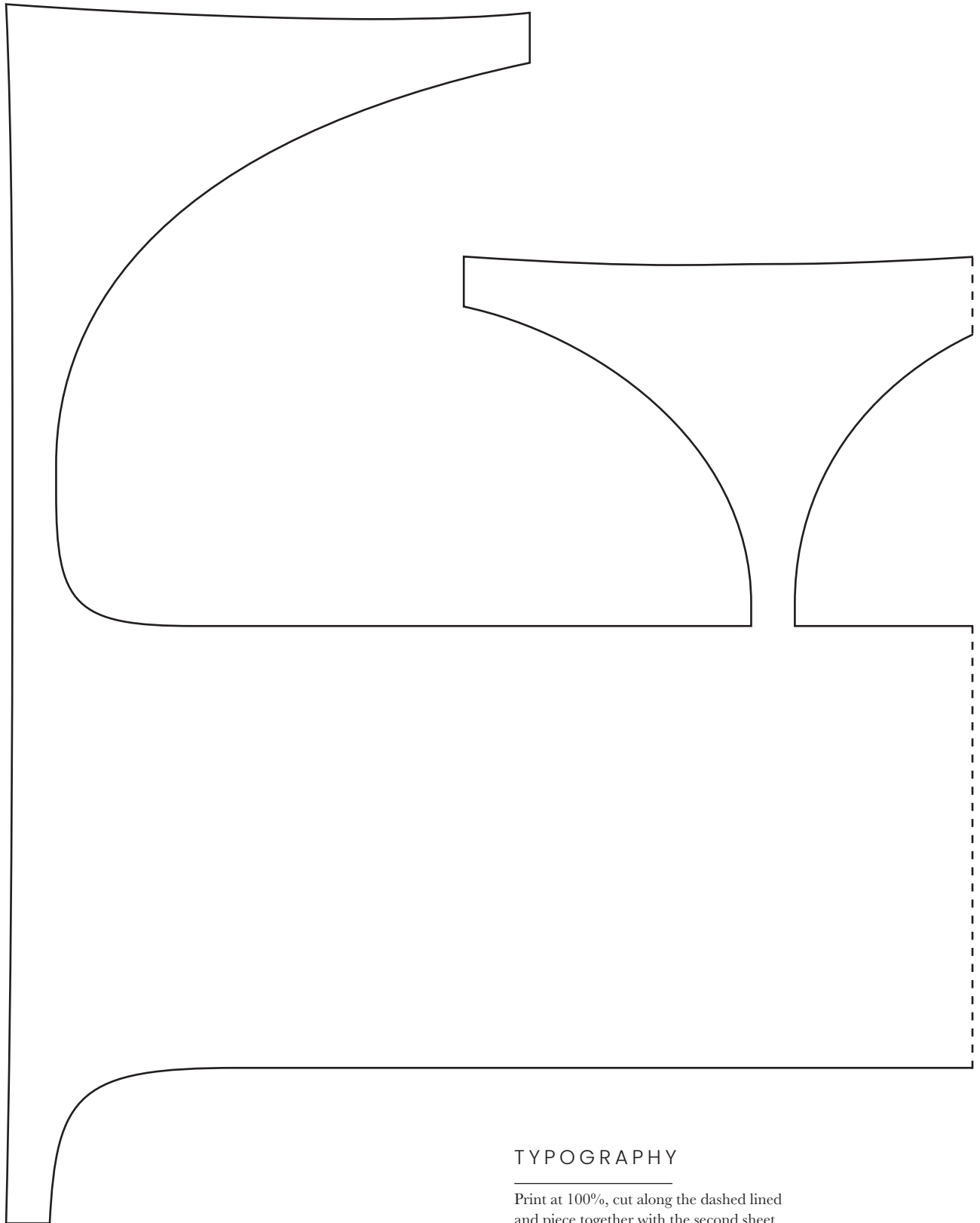

TYPOGRAPHY

Print at 100%, cut along the dashed lined
and piece together with the second sheet

DRIED FLOWER EMBROIDERY

BY OLGA PRINKU

TYPOGRAPHY

Print at 100%, cut along the dashed lined
and piece together with the second sheet

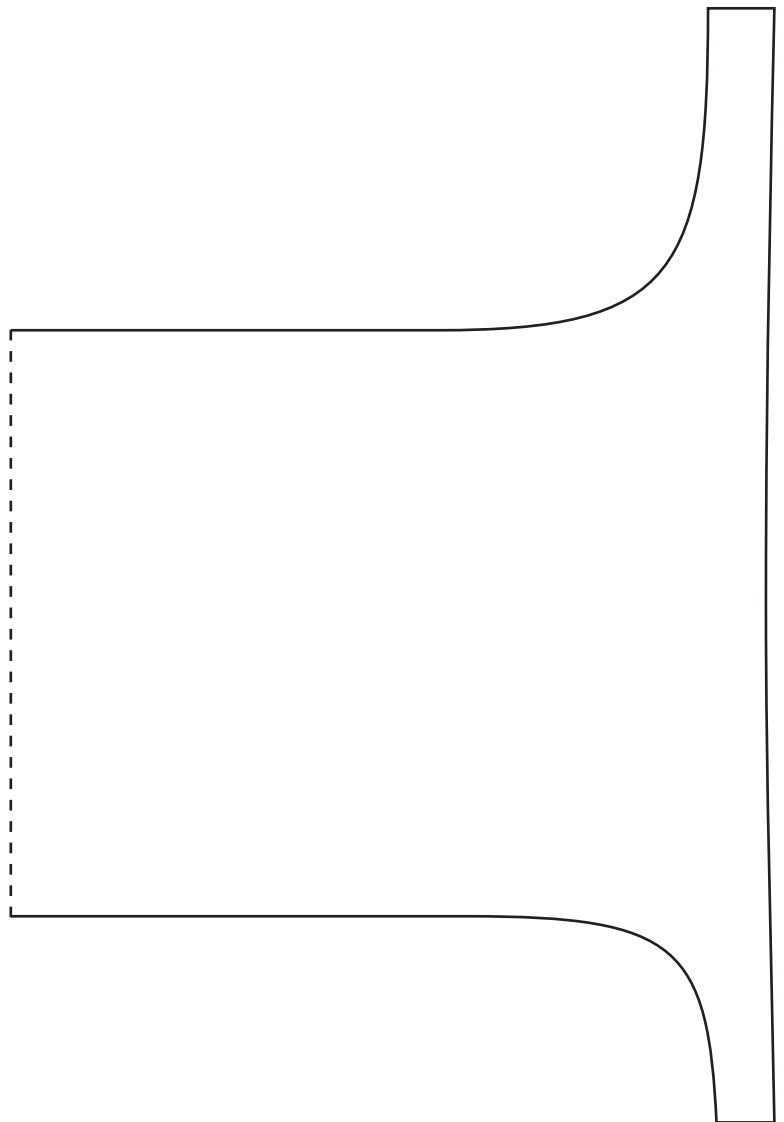



DRIED FLOWER EMBROIDERY

BY OLGA PRINKU

TYPOGRAPHY

Print at 100%, cut along the dashed lined
and piece together with the second sheet

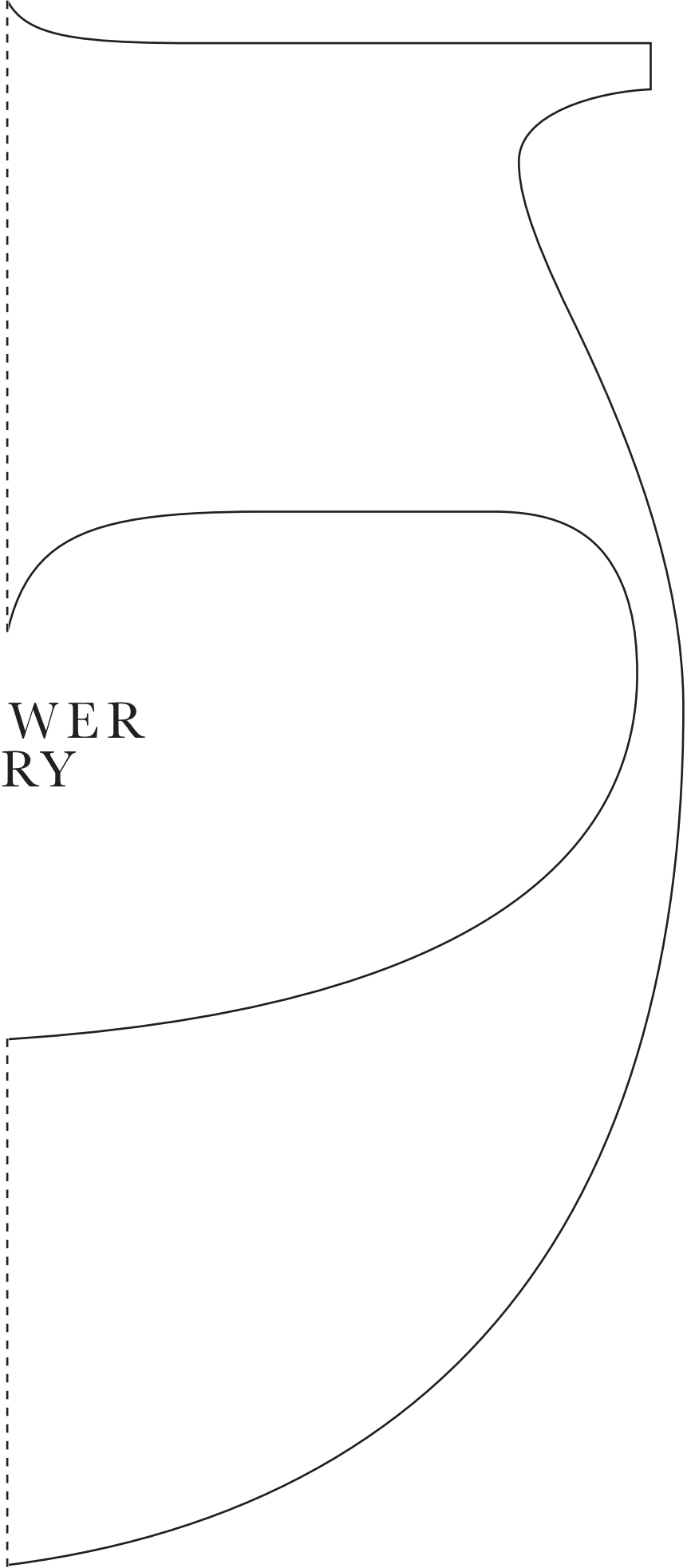

DRIED FLOWER EMBROIDERY

BY OLGA PRINKU

TYPOGRAPHY

Print at 100%, cut along the dashed lined
and piece together with the second sheet

DRIED FLOWER EMBROIDERY

BY OLGA PRINKU

TYPOGRAPHY

Print at 100%, cut along the dashed lined
and piece together with the second sheet

DRIED FLOWER EMBROIDERY

BY OLGA PRINKU

TYPOGRAPHY

Print at 100%, cut along the dashed lined
and piece together with the second sheet

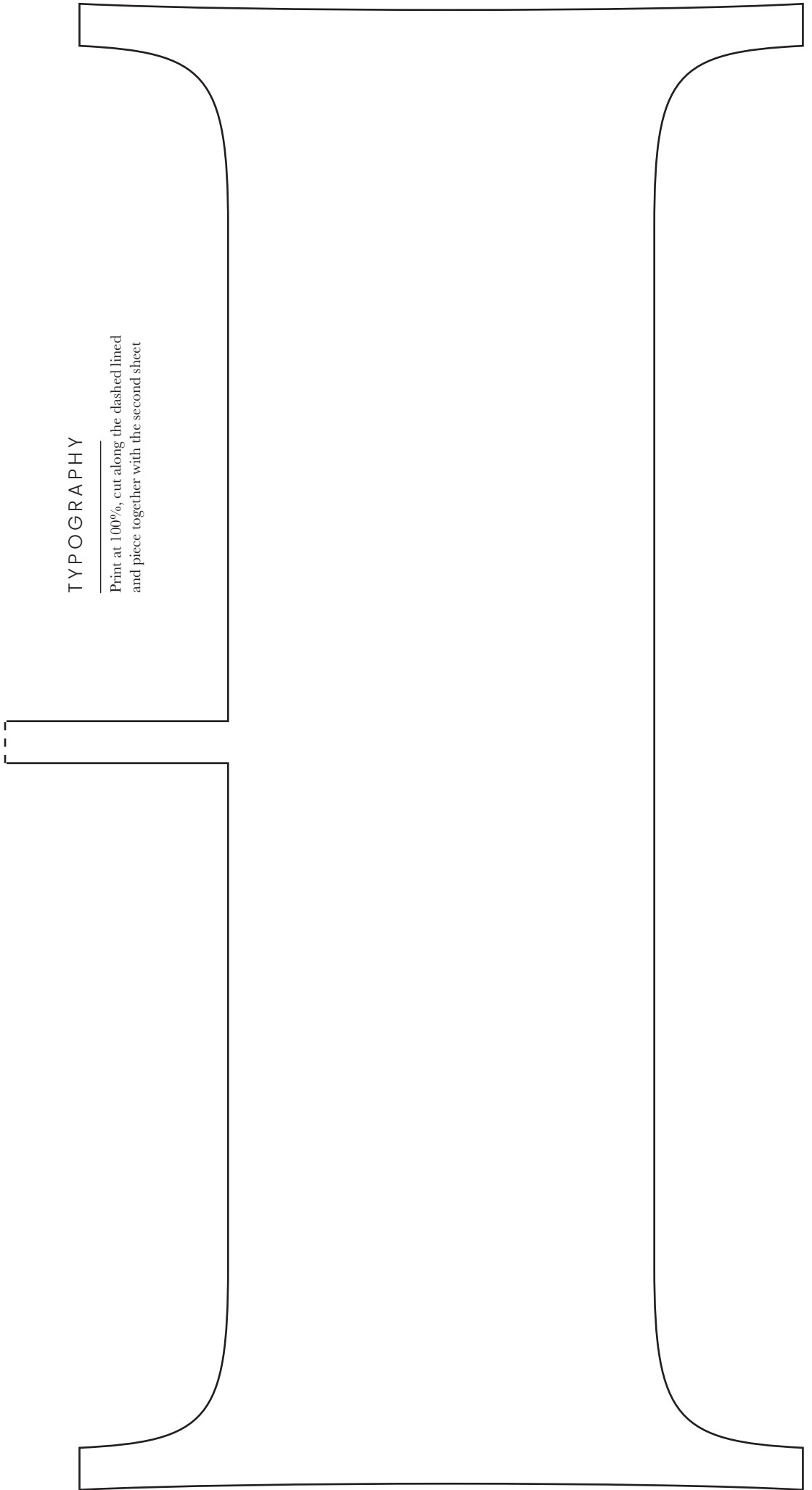

DRIED FLOWER EMBROIDERY

BY OLGA PRINKU

TYPOGRAPHY

Print at 100%, cut along the dashed lined
and piece together with the second sheet

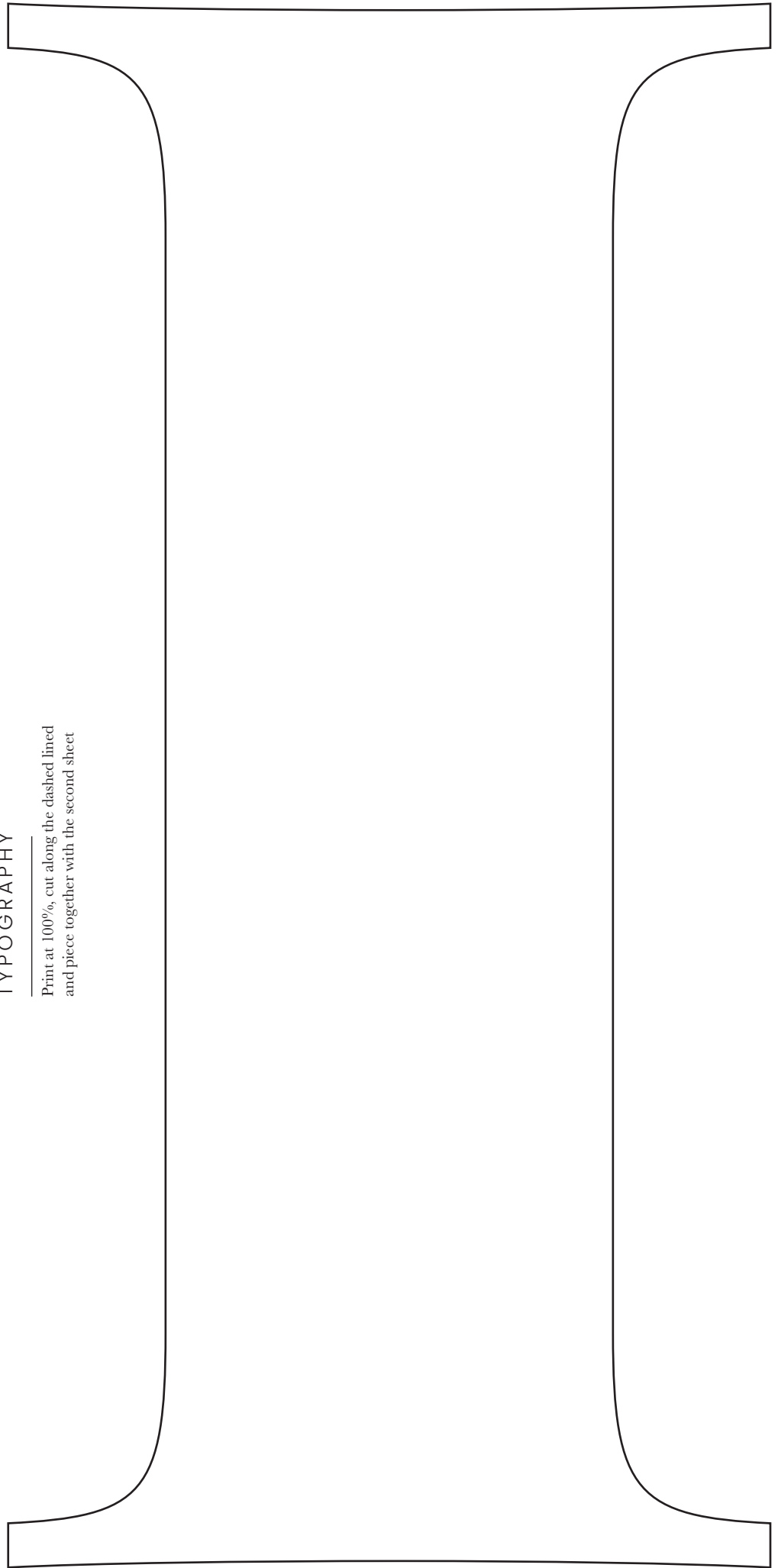

DRIED FLOWER EMBROIDERY

BY OLGA PRINKU

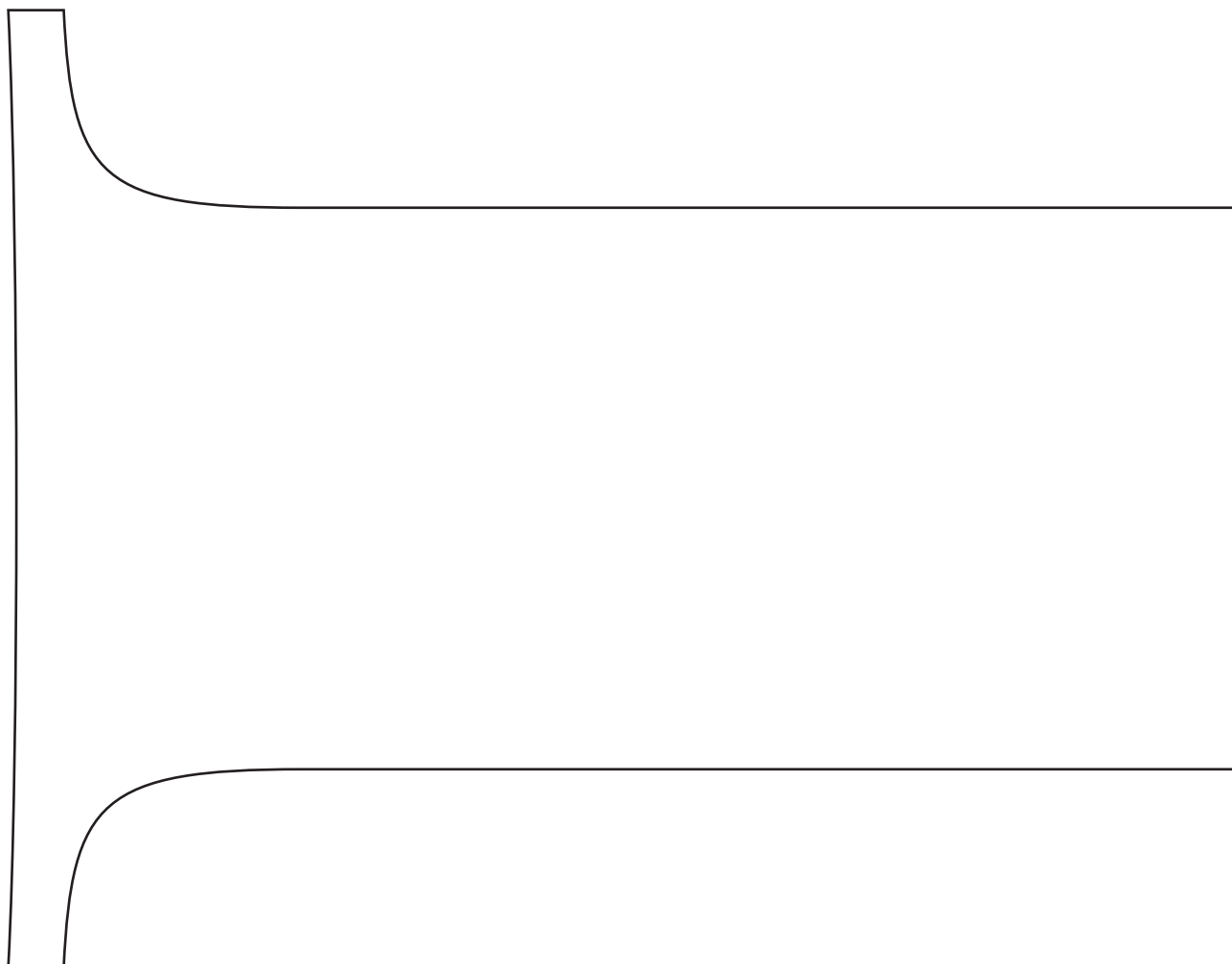

TYPOGRAPHY

Print at 100%, cut along the dashed lined
and piece together with the second sheet

DRIED FLOWER EMBROIDERY

BY OLGA PRINKU

TYPOGRAPHY

Print at 100%, cut along the dashed lined
and piece together with the second sheet

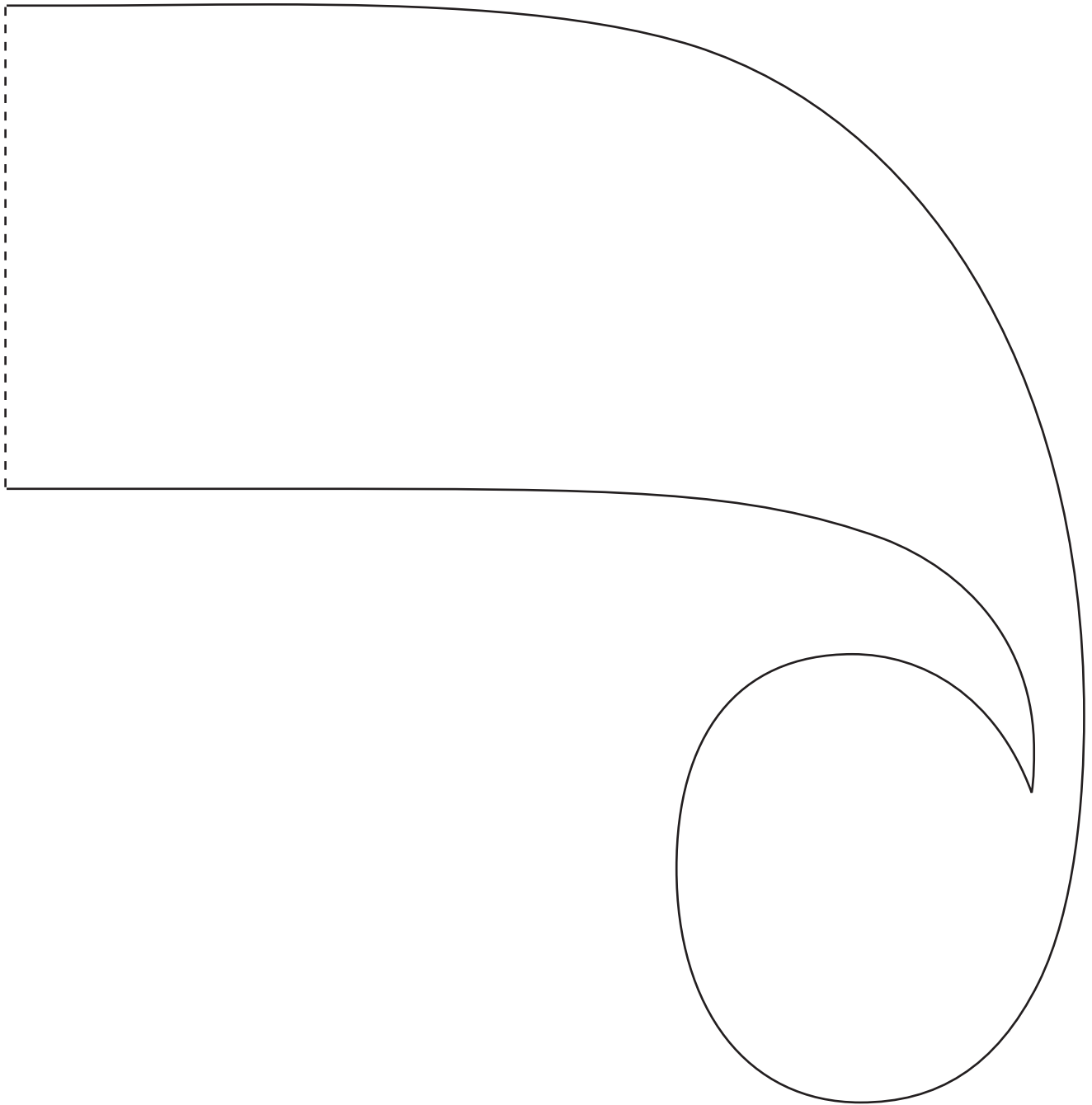

DRIED FLOWER EMBROIDERY

BY OLGA PRINKU

TYPOGRAPHY

Print at 100%, cut along the dashed lined
and piece together with the second sheet

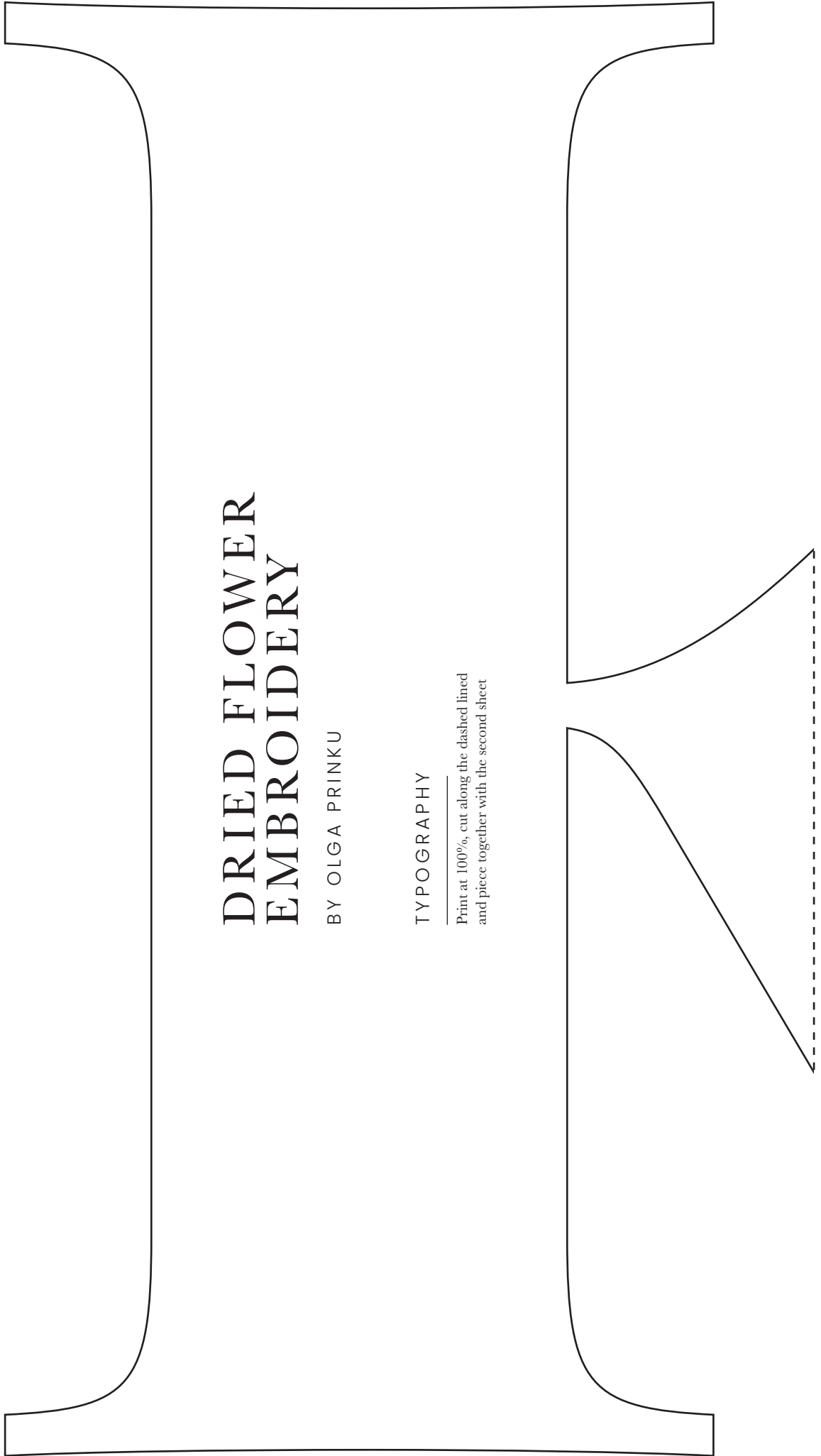



DRIED FLOWER EMBROIDERY

BY OLGA PRINKU

TYPOGRAPHY

Print at 100%, cut along the dashed lined
and piece together with the second sheet

DRIED FLOWER EMBROIDERY

BY OLGA PRINKU

TYPOGRAPHY

Print at 100%, cut along the dashed lined
and piece together with the second sheet

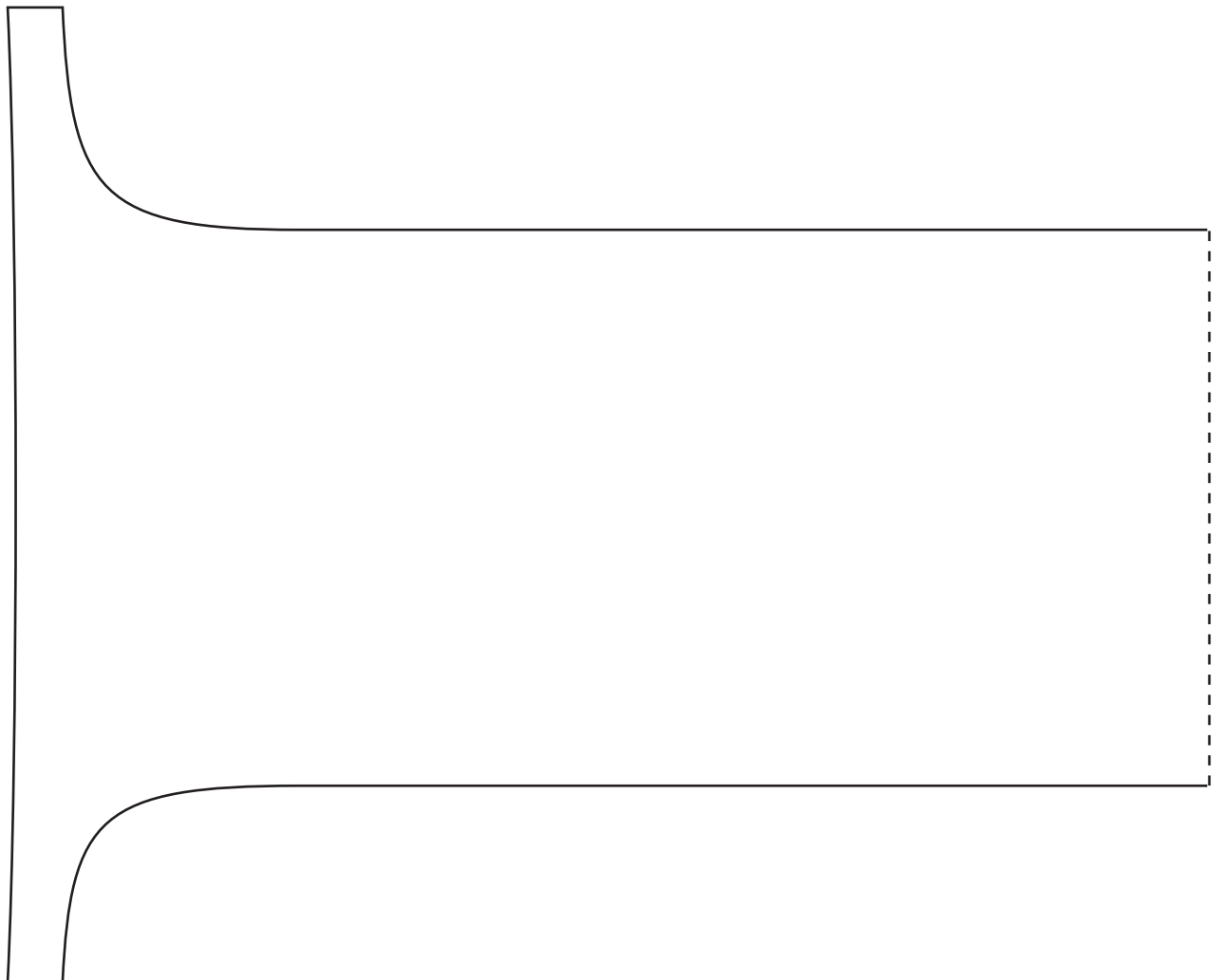

DRIED FLOWER EMBROIDERY

BY OLGA PRINKU

TYPOGRAPHY

Print at 100%, cut along the dashed lined
and piece together with the second sheet

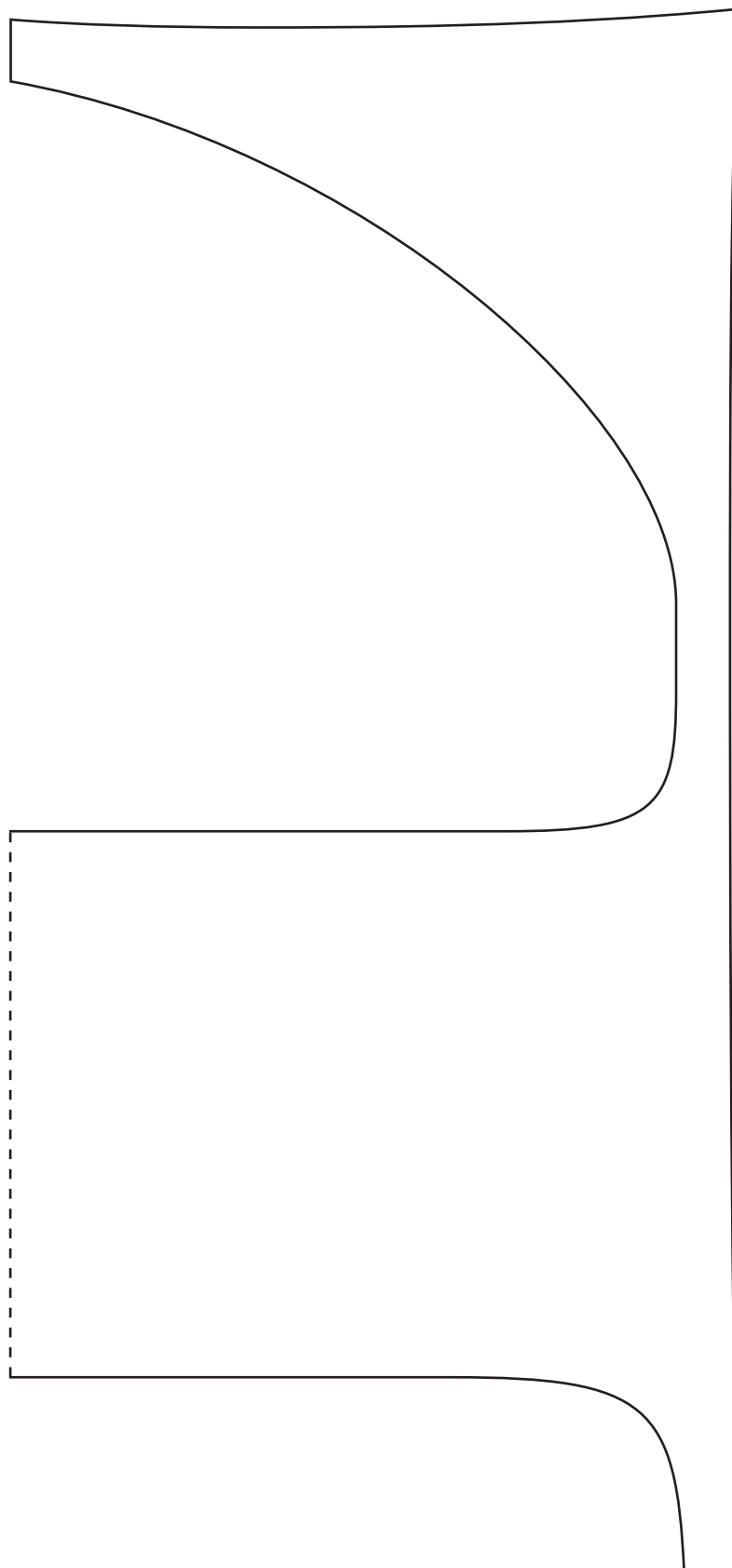

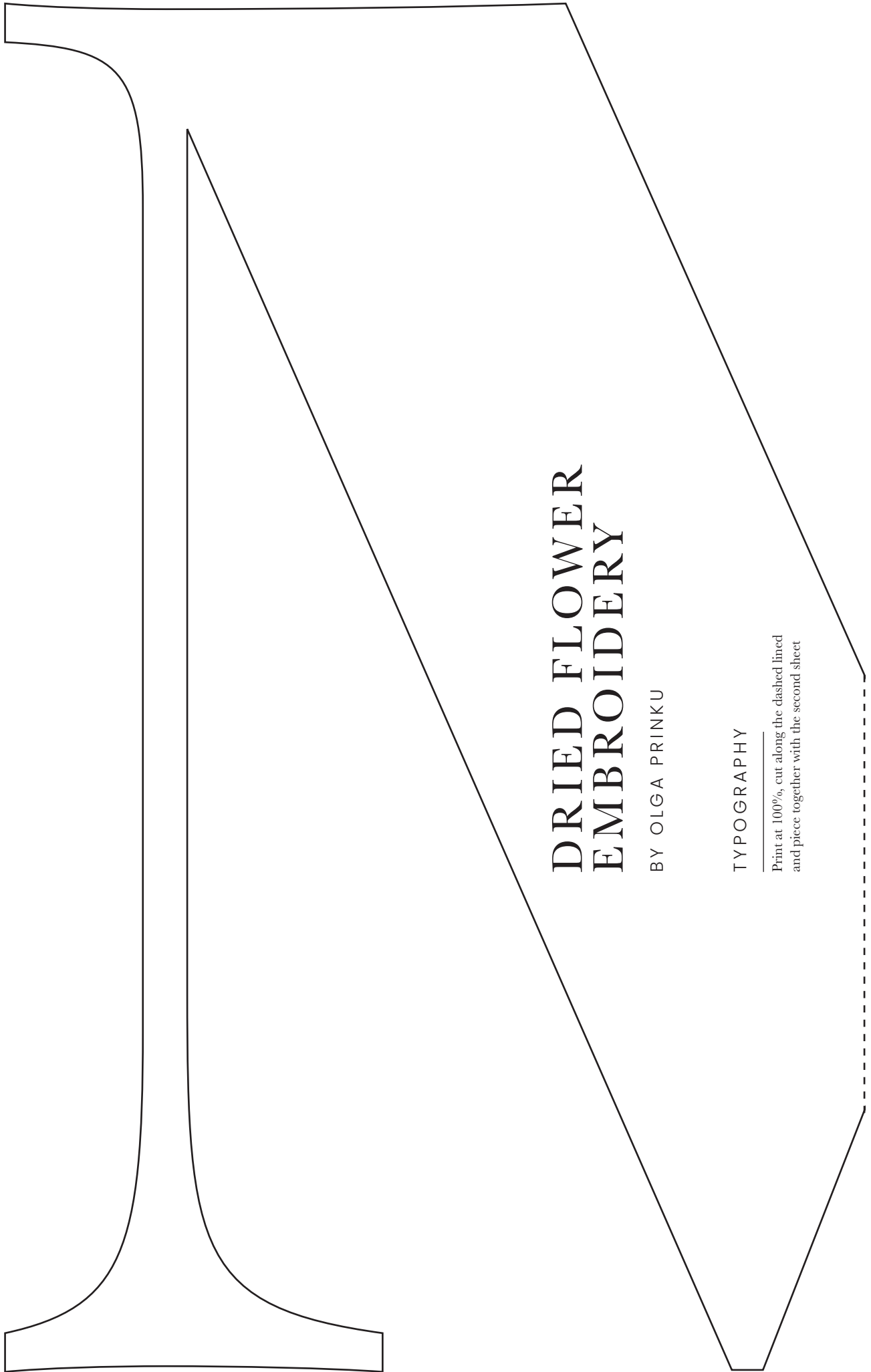

DRIED FLOWER EMBROIDERY

BY OLGA PRINKU

TYPOGRAPHY

Print at 100%, cut along the dashed lined
and piece together with the second sheet

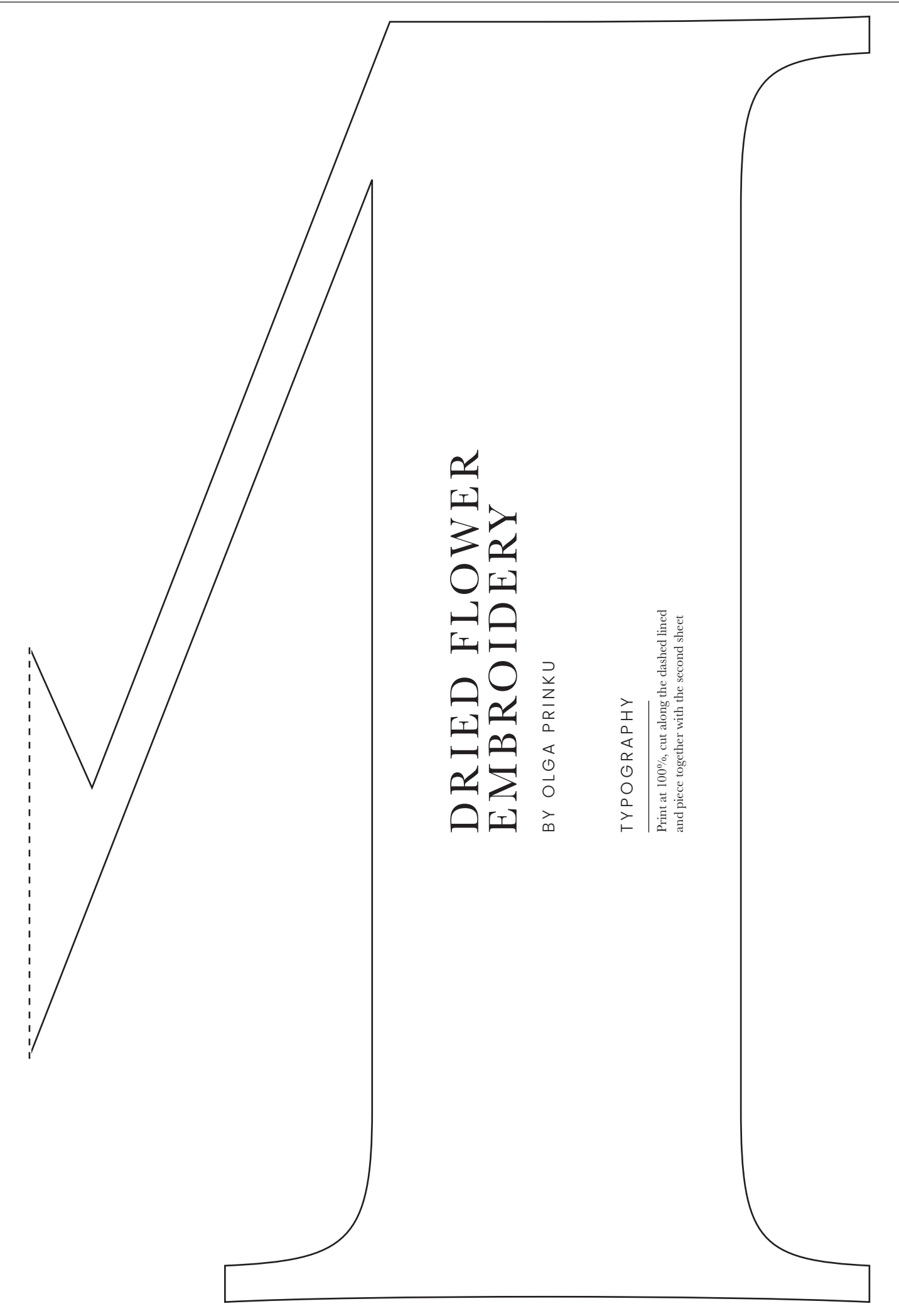

DRIED FLOWER EMBROIDERY

BY OLGA PRINKU

TYPOGRAPHY

Print at 100%, cut along the dashed lined
and piece together with the second sheet

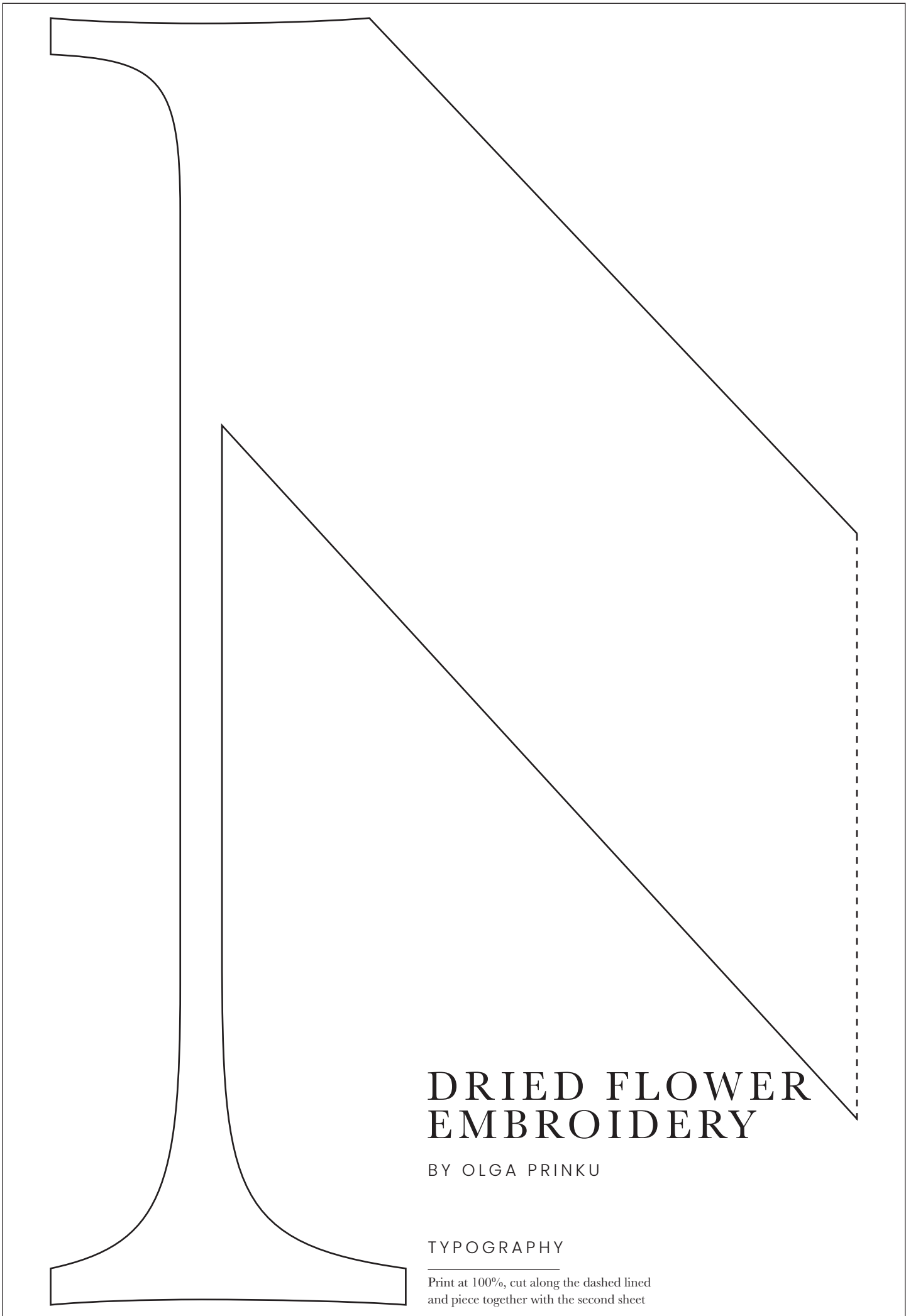

DRIED FLOWER EMBROIDERY

BY OLGA PRINKU

TYPOGRAPHY

Print at 100%, cut along the dashed lined
and piece together with the second sheet

DRIED FLOWER EMBROIDERY

BY OLGA PRINKU

TYPOGRAPHY

Print at 100%, cut along the dashed lined
and piece together with the second sheet

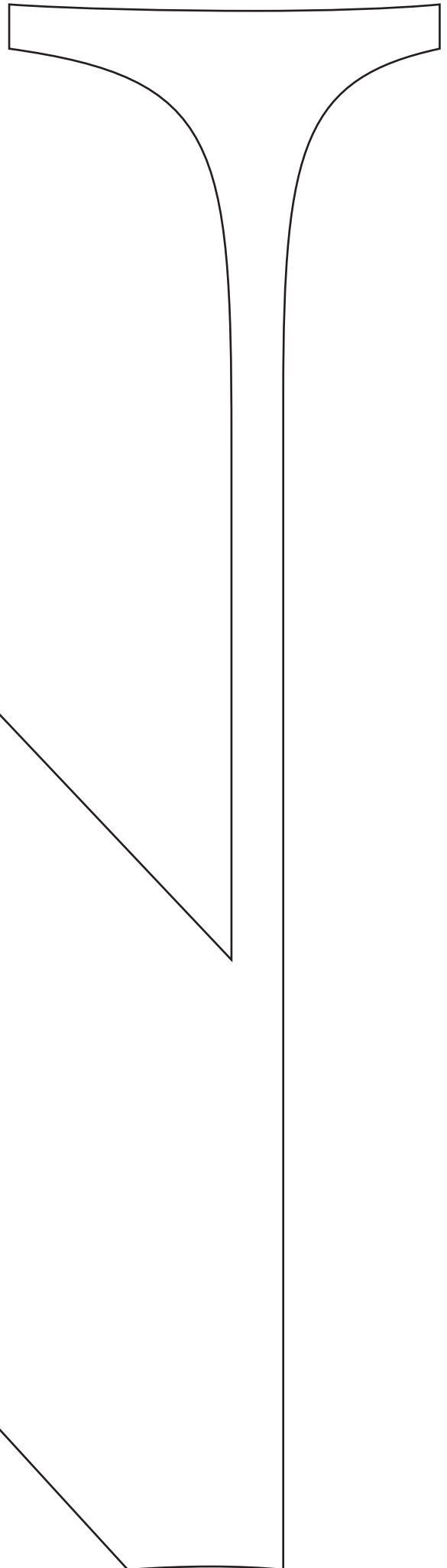



DRIED FLOWER EMBROIDERY

BY OLGA PRINKU

TYPOGRAPHY

Print at 100%, cut along the dashed lined
and piece together with the second sheet

DRIED FLOWER EMBROIDERY

BY OLGA PRINKU

TYPOGRAPHY

Print at 100%, cut along the dashed lined
and piece together with the second sheet

DRIED FLOWER EMBROIDERY

BY OLGA PRINKU

TYPOGRAPHY

Print at 100%, cut along the dashed lined
and piece together with the second sheet

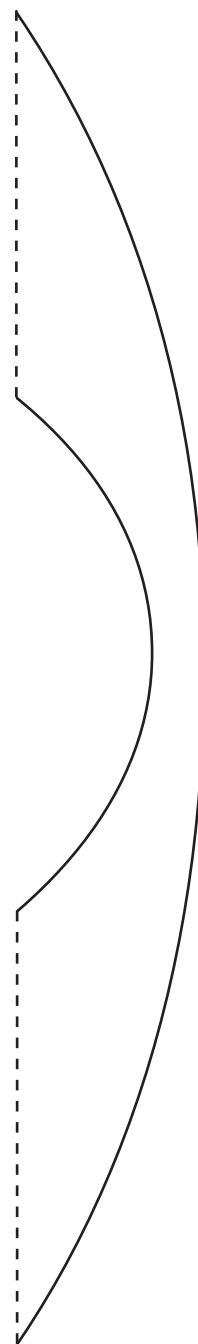

DRIED FLOWER EMBROIDERY

BY OLGA PRINKU

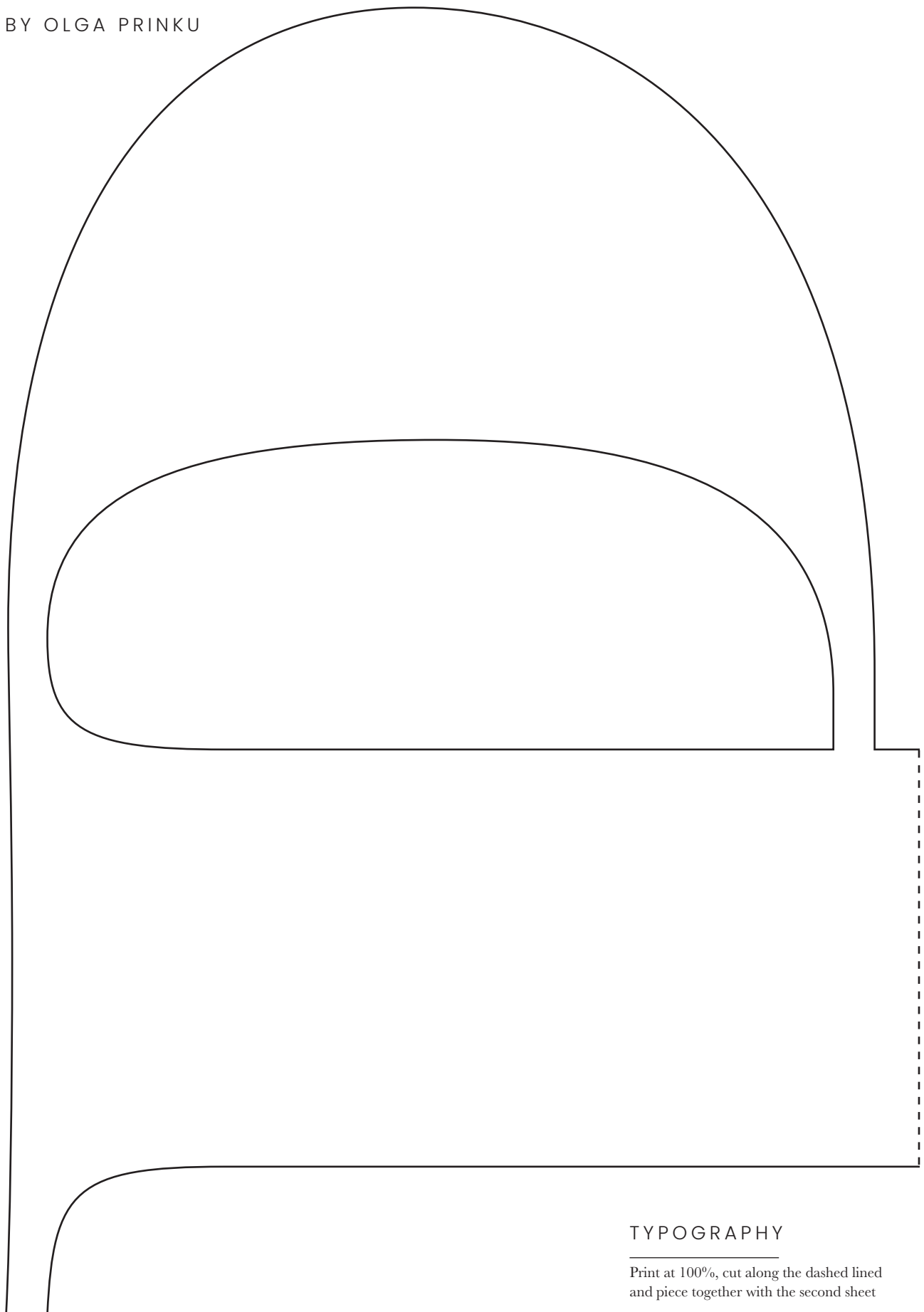

TYPOGRAPHY

Print at 100%, cut along the dashed lined
and piece together with the second sheet

DRIED FLOWER EMBROIDERY

BY OLGA PRINKU

TYPOGRAPHY

Print at 100%, cut along the dashed lined
and piece together with the second sheet

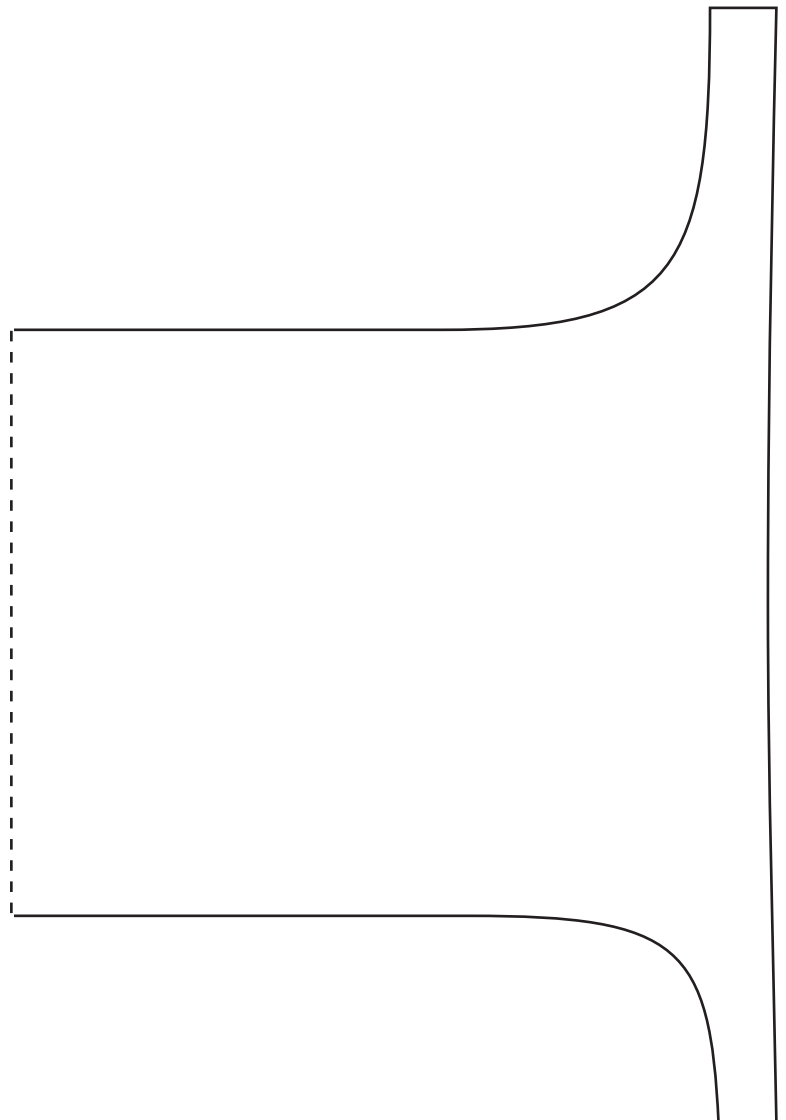

DRIED FLOWER EMBROIDERY

BY OLGA PRINKU

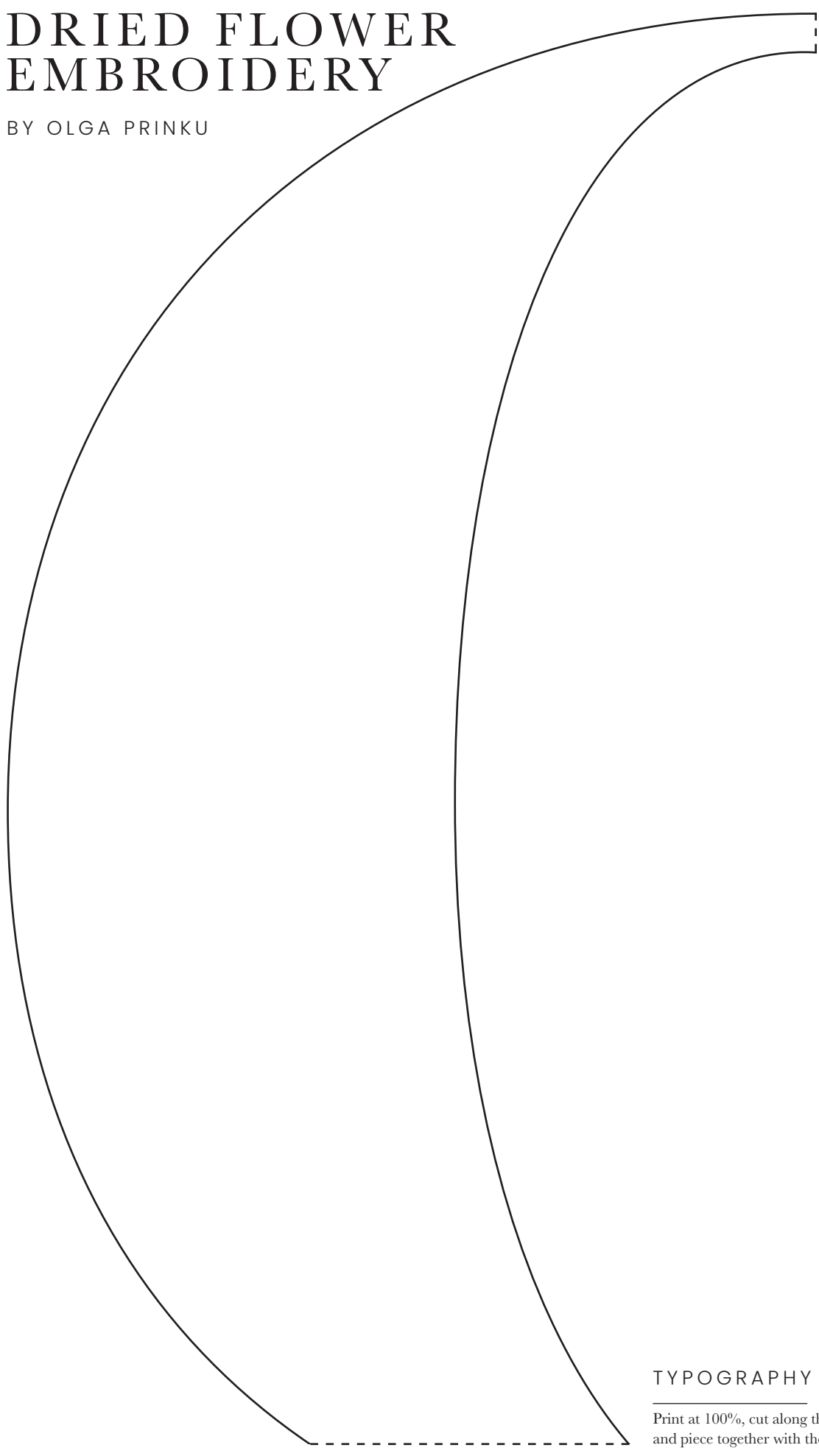

TYPOGRAPHY

Print at 100%, cut along the dashed lined
and piece together with the second sheet

DRIED FLOWER EMBROIDERY

BY OLGA PRINKU

TYPOGRAPHY

Print at 100%, cut along the dashed lined
and piece together with the second sheet

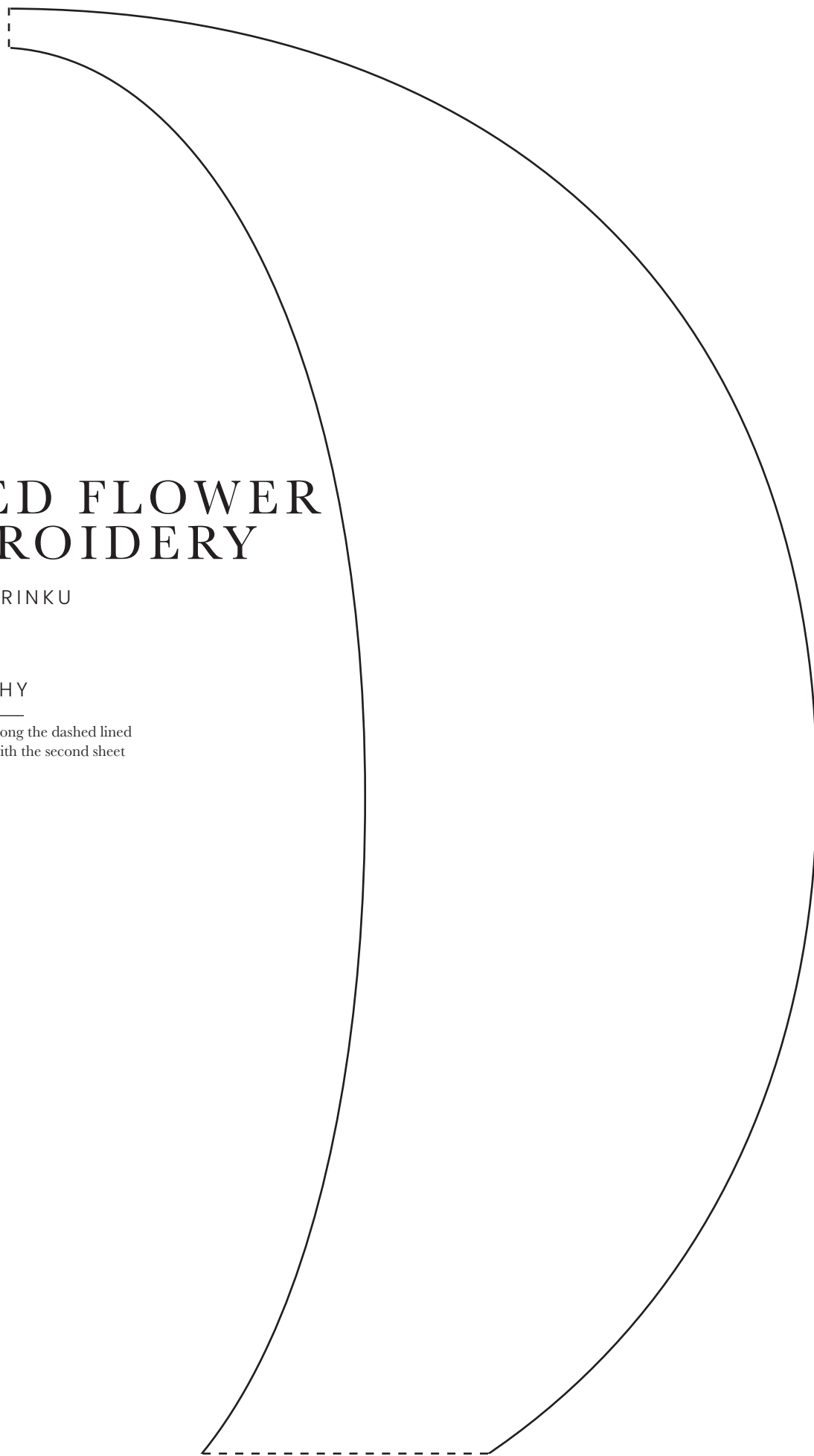

DRIED FLOWER EMBROIDERY

BY OLGA PRINKU

TYPOGRAPHY

Print at 100%, cut along the dashed lined
and piece together with the second sheet

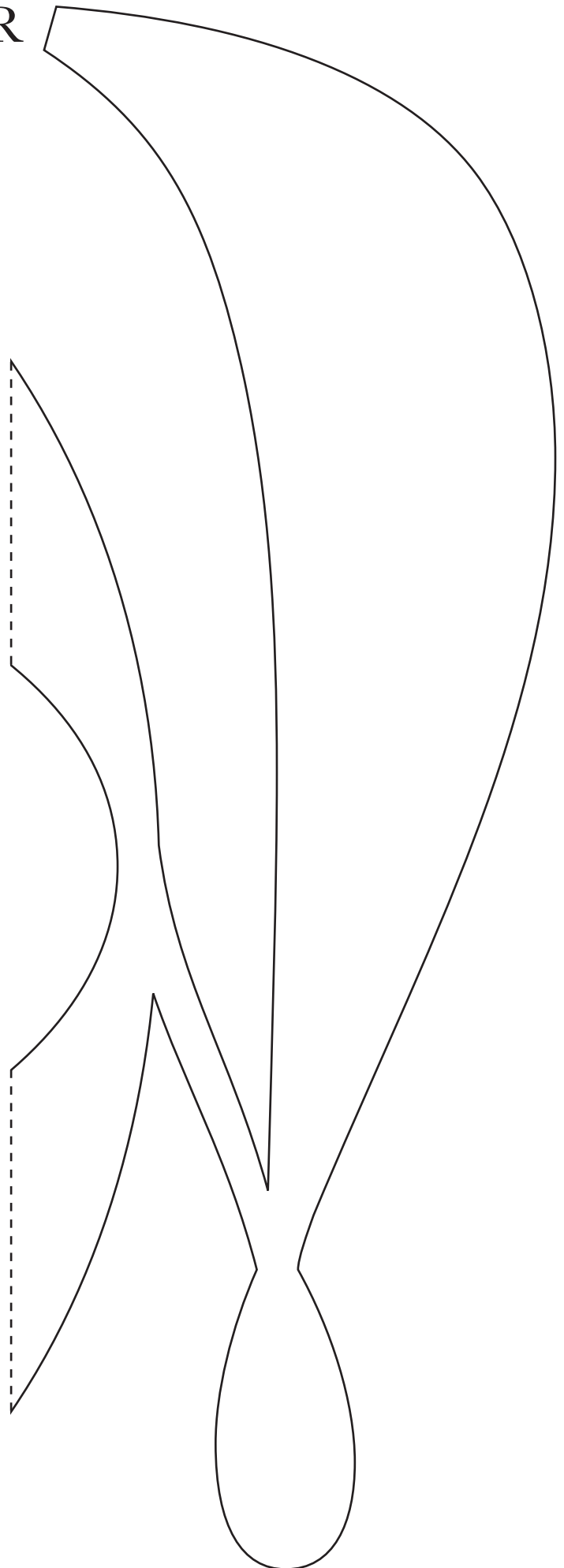

DRIED FLOWER EMBROIDERY

BY OLGA PRINKU

TYPOGRAPHY

Print at 100%, cut along the dashed lined
and piece together with the second sheet

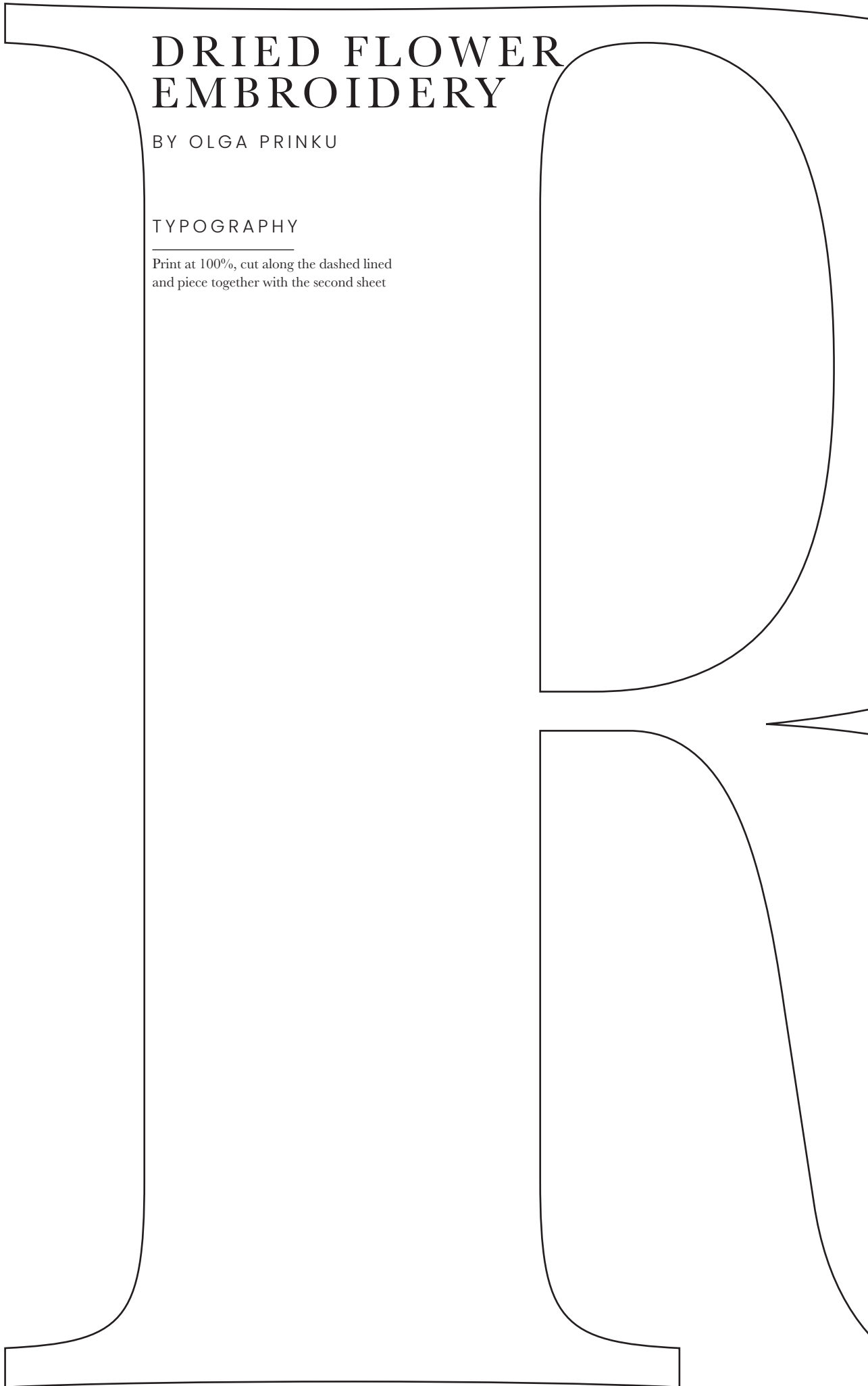

DRIED FLOWER EMBROIDERY

BY OLGA PRINKU

TYPOGRAPHY

Print at 100%, cut along the dashed lined
and piece together with the second sheet

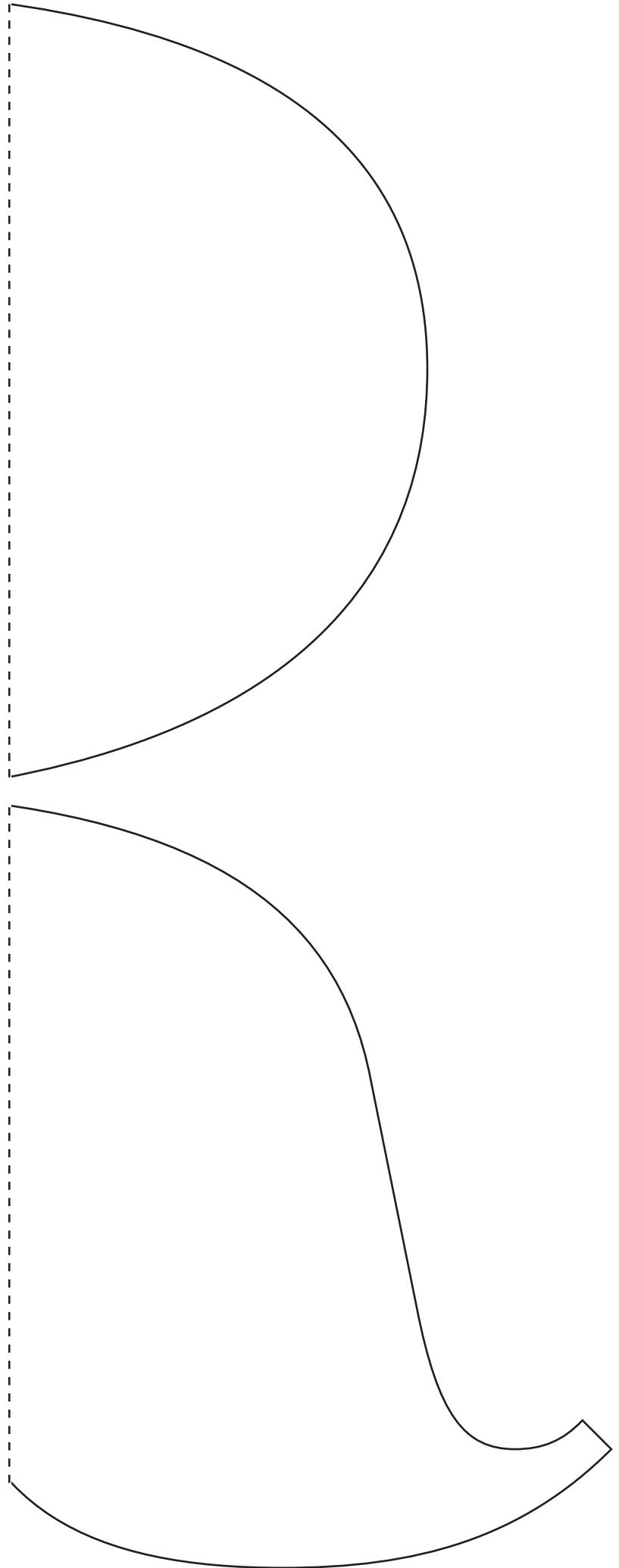

DRIED FLOWER EMBROIDERY

BY OLGA PRINKU

TYPOGRAPHY

Print at 100%, cut along the dashed lined
and piece together with the second sheet

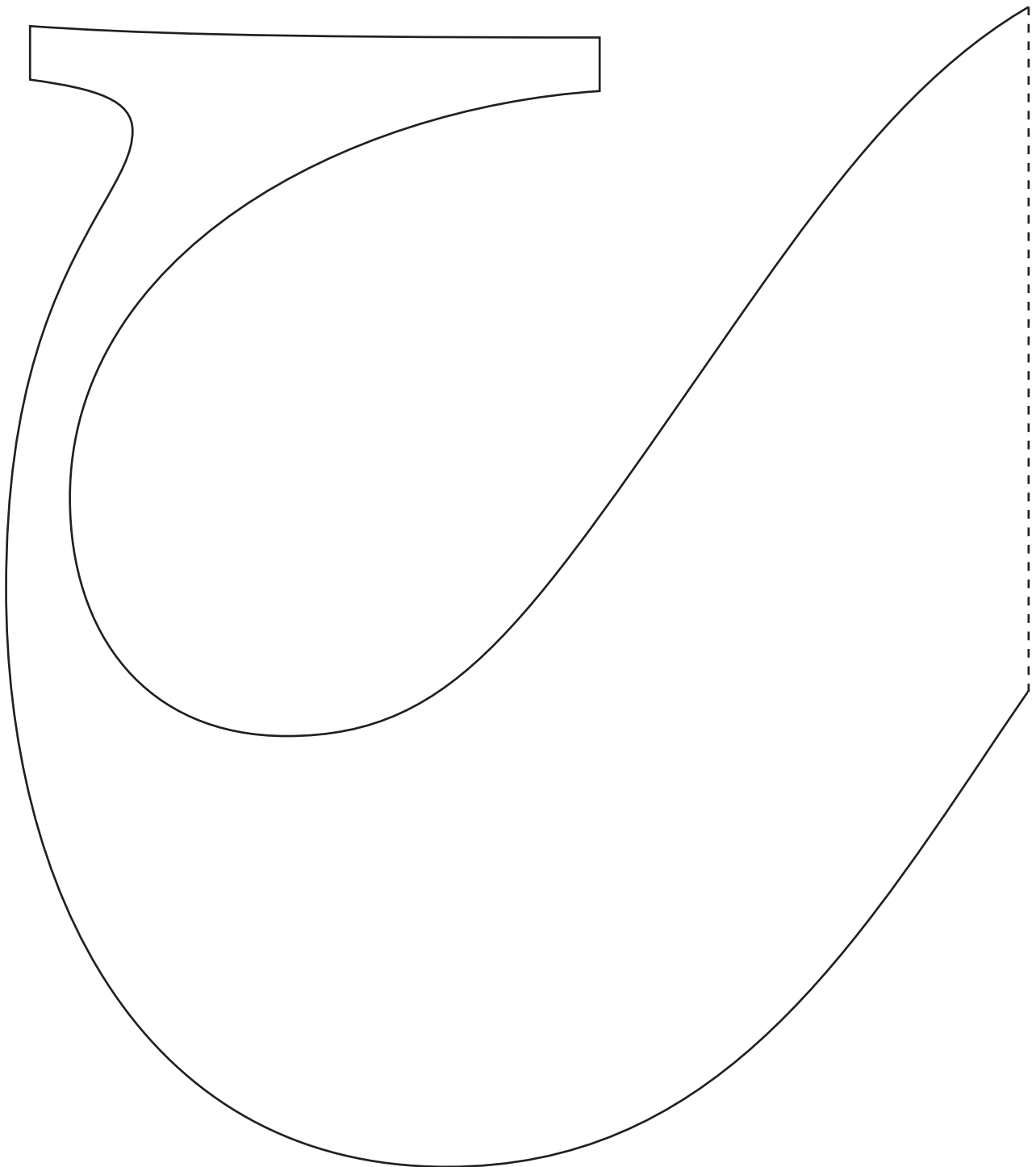

DRIED FLOWER EMBROIDERY

BY OLGA PRINKU

TYPOGRAPHY

Print at 100%, cut along the dashed lined
and piece together with the second sheet

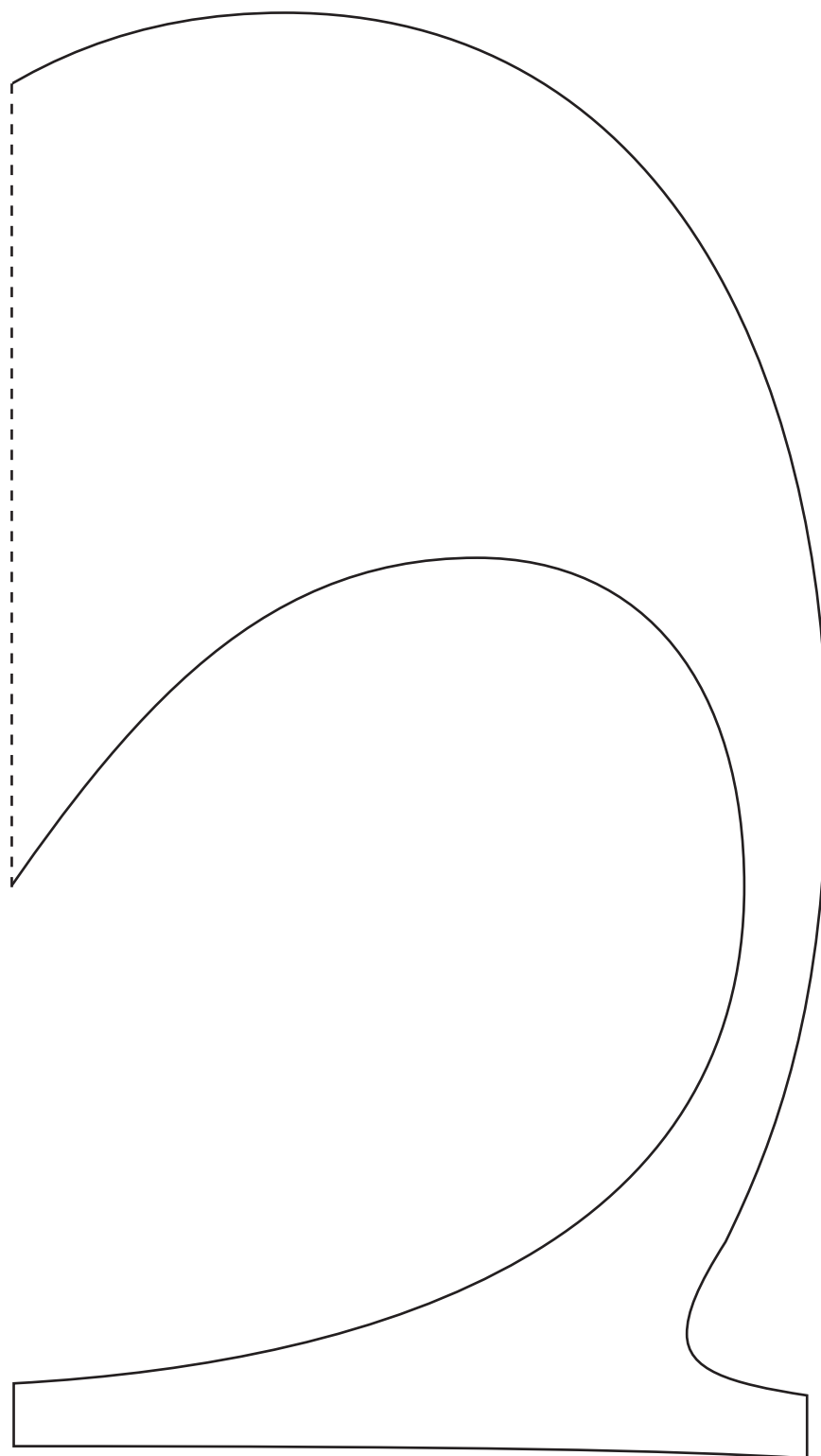

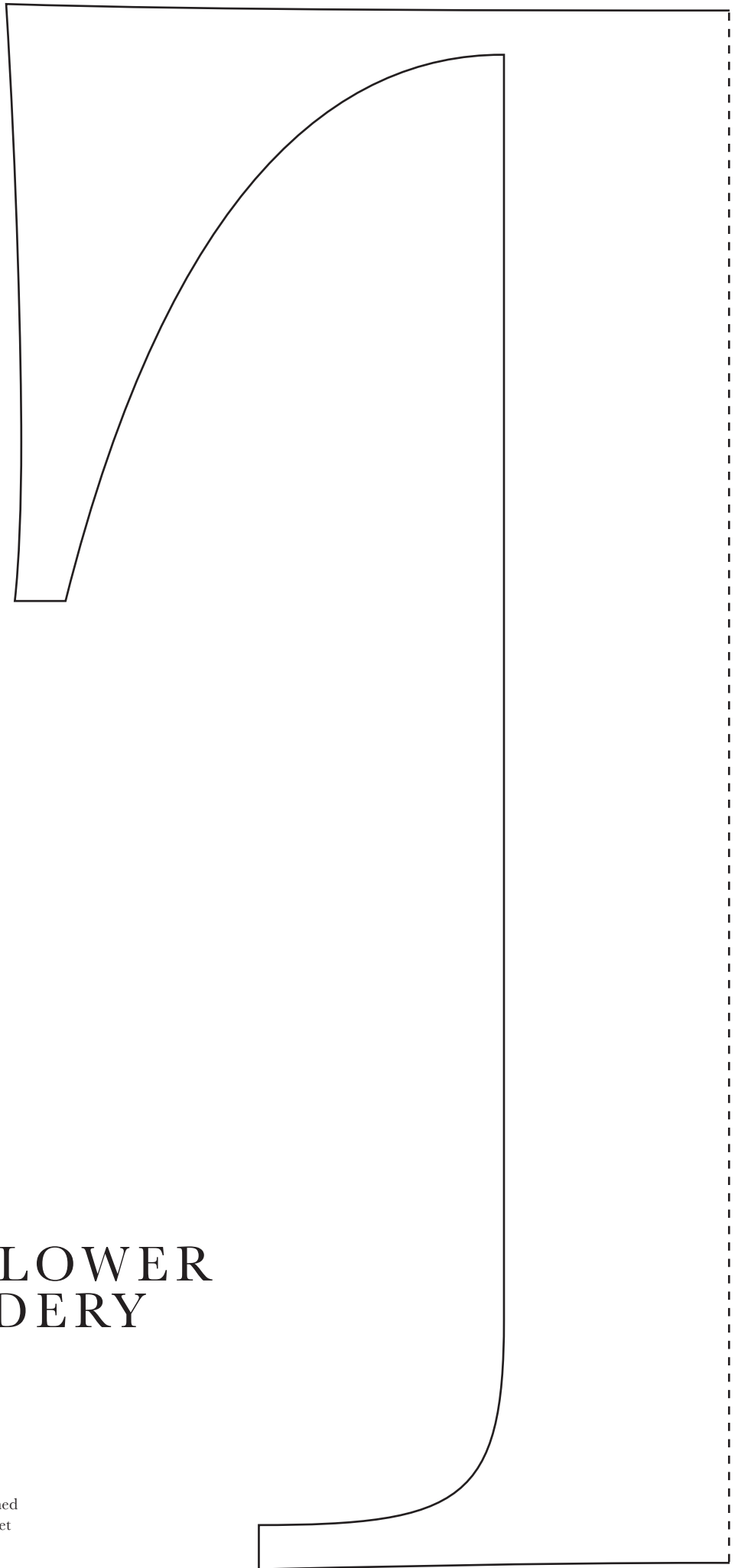

DRIED FLOWER EMBROIDERY

BY OLGA PRINKU

TYPOGRAPHY

Print at 100%, cut along the dashed lined
and piece together with the second sheet



DRIED FLOWER EMBROIDERY

BY OLGA PRINKU

TYPOGRAPHY

Print at 100%, cut along the dashed lined
and piece together with the second sheet

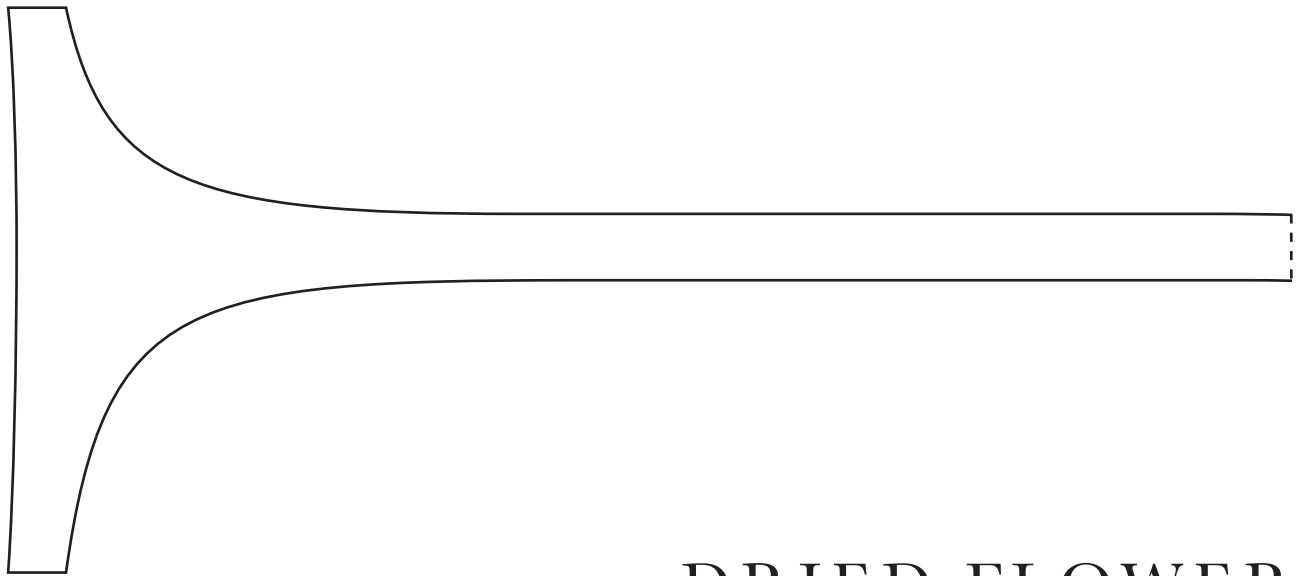

DRIED FLOWER EMBROIDERY

BY OLGA PRINKU

TYPOGRAPHY

Print at 100%, cut along the dashed lined
and piece together with the second sheet

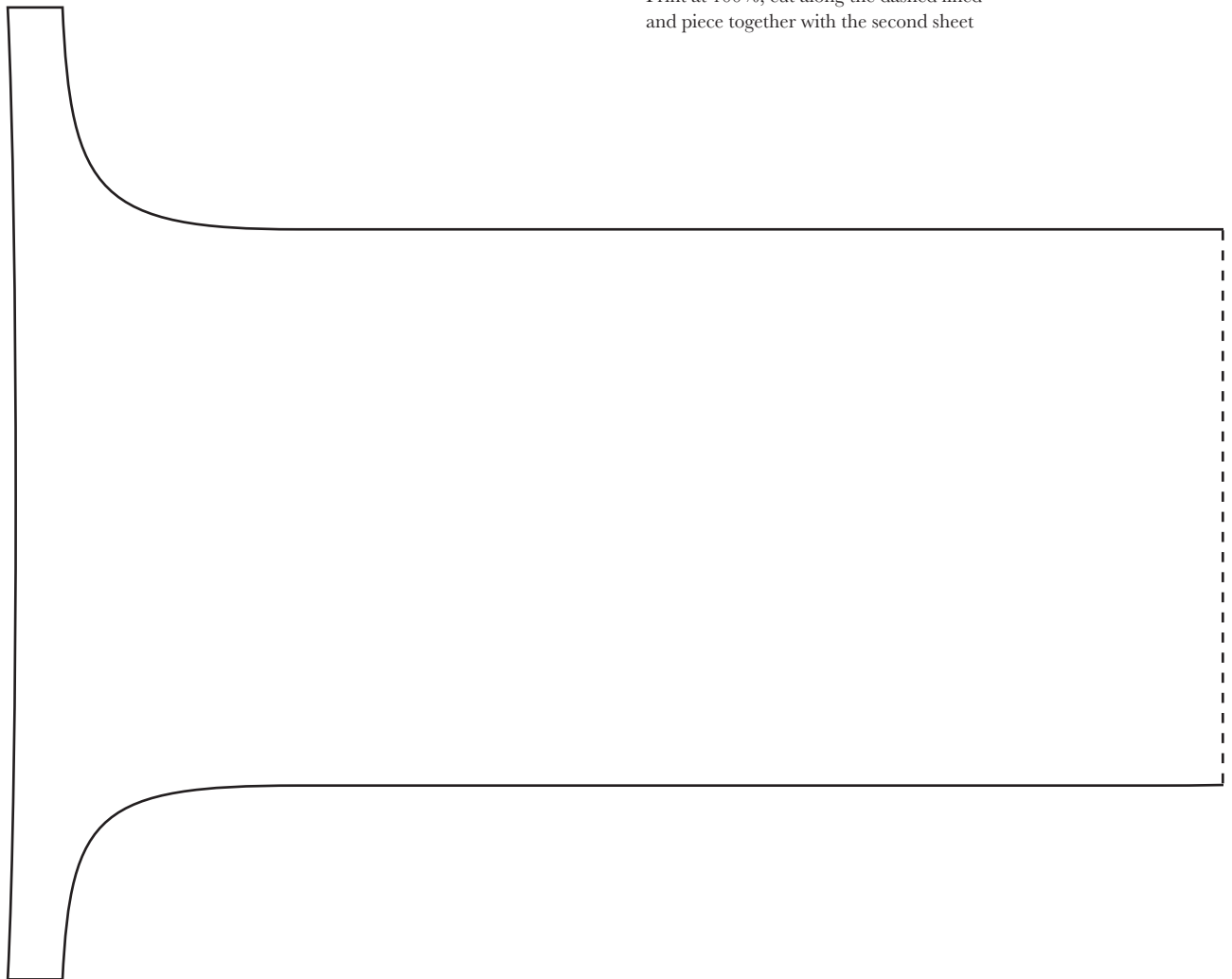

DRIED FLOWER EMBROIDERY

BY OLGA PRINKU

TYPOGRAPHY

Print at 100%, cut along the dashed lined
and piece together with the second sheet

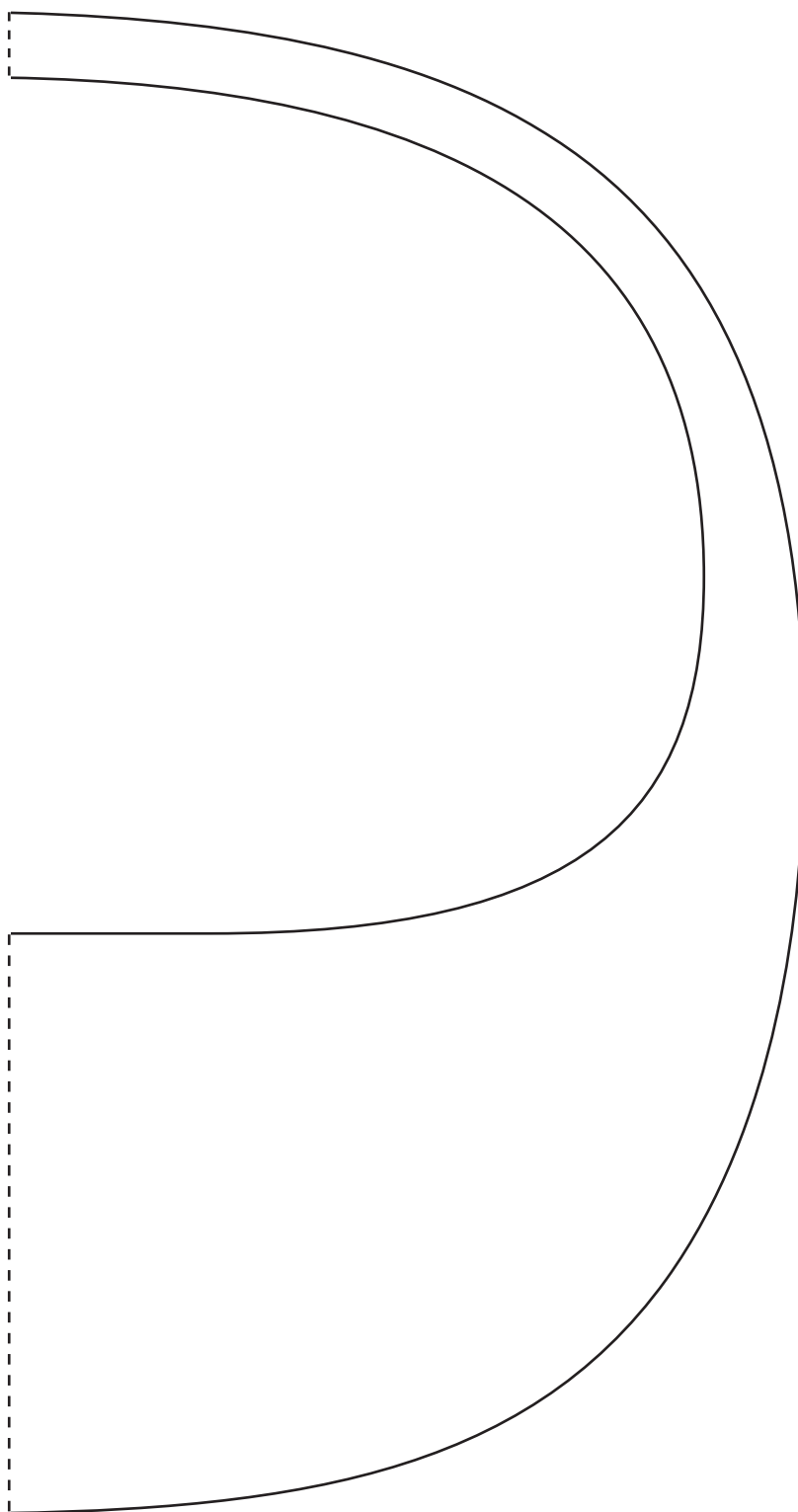

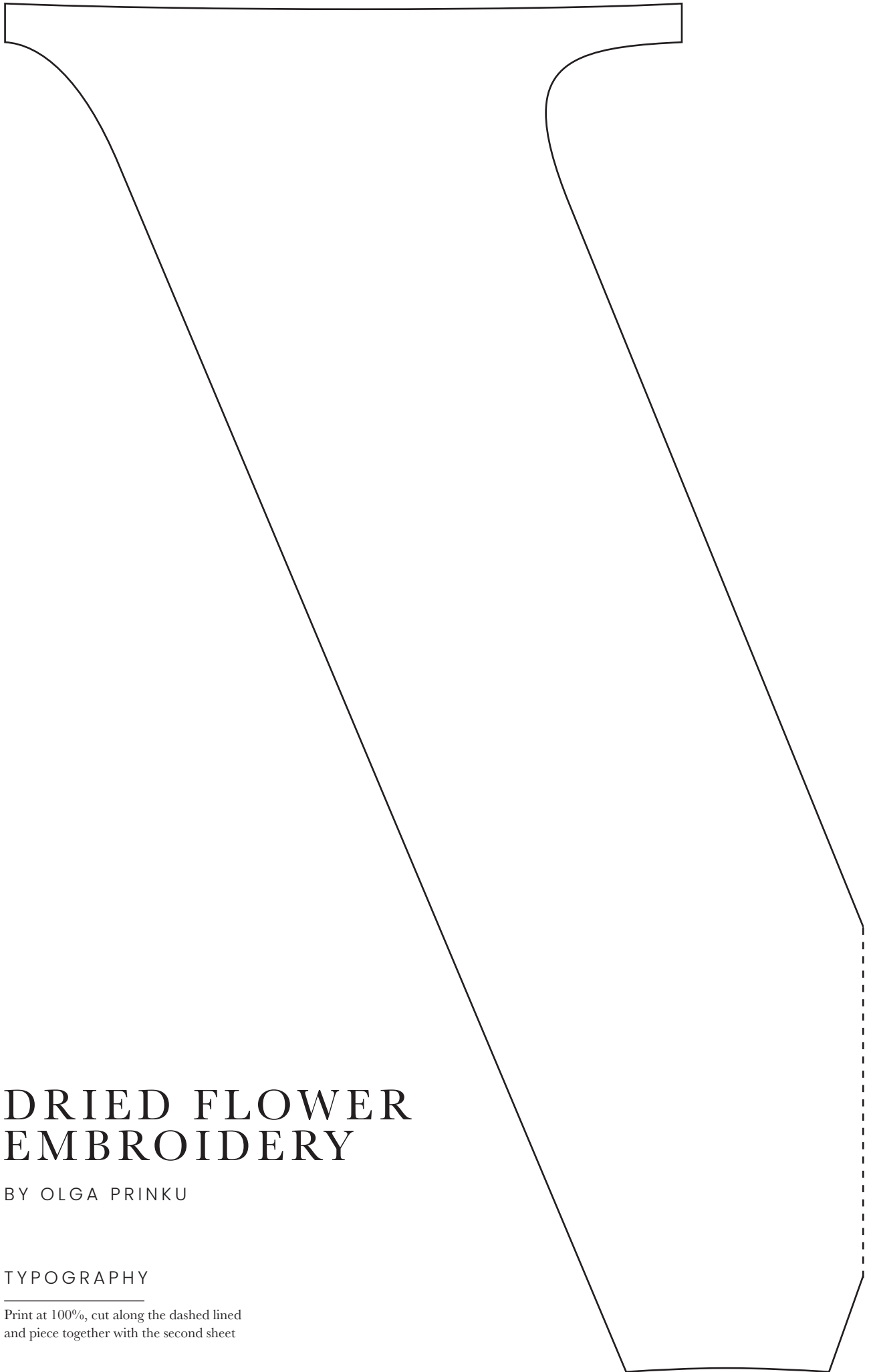

DRIED FLOWER EMBROIDERY

BY OLGA PRINKU

TYPOGRAPHY

Print at 100%, cut along the dashed lined
and piece together with the second sheet

DRIED FLOWER EMBROIDERY

BY OLGA PRINKU

TYPOGRAPHY

Print at 100%, cut along the dashed lined
and piece together with the second sheet

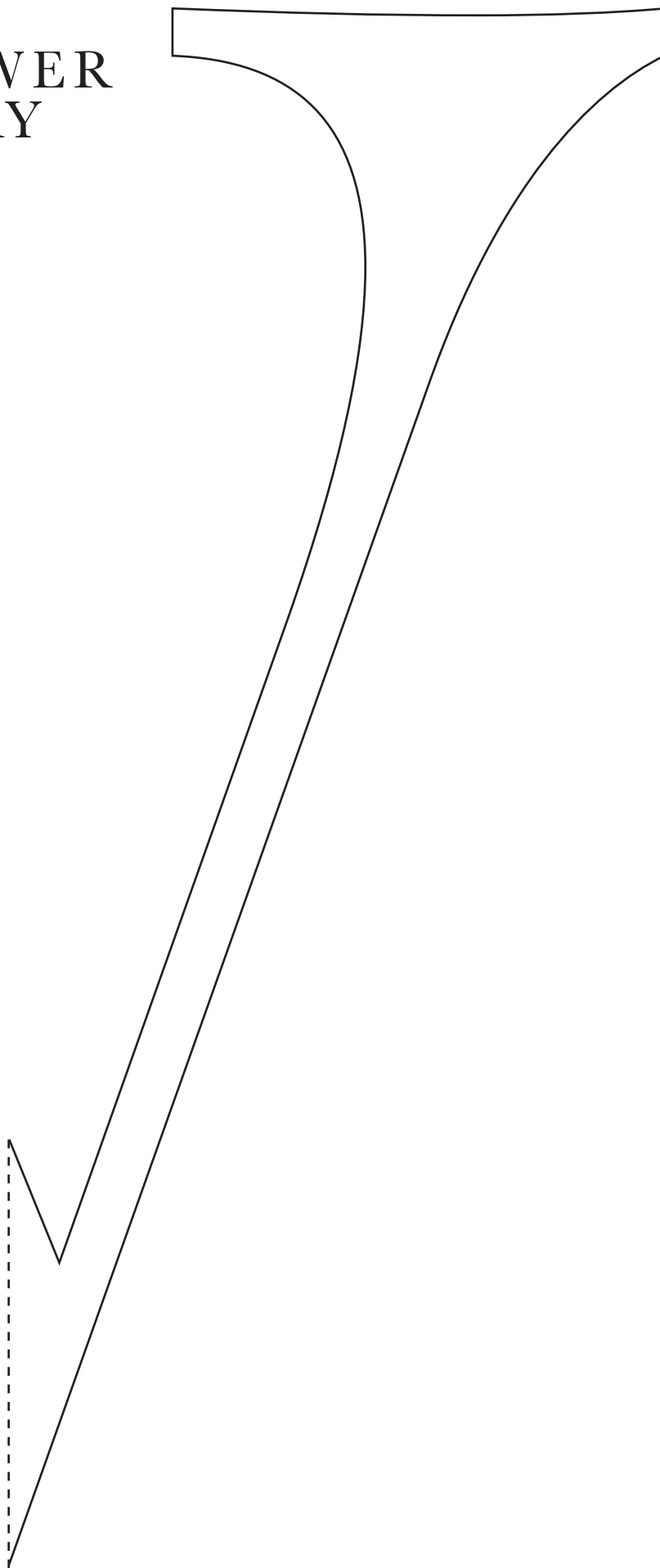

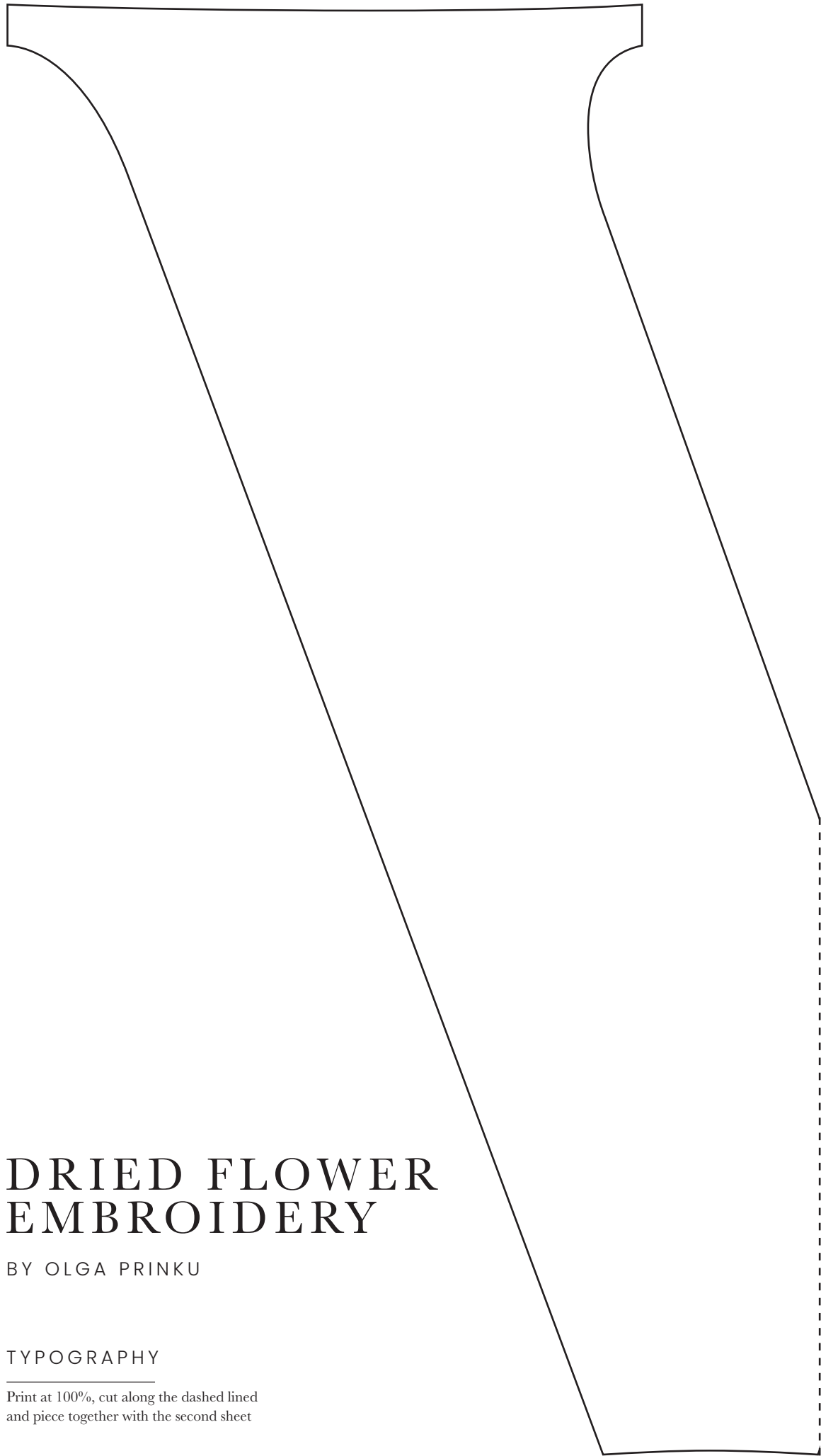

DRIED FLOWER EMBROIDERY

BY OLGA PRINKU

TYPOGRAPHY

Print at 100%, cut along the dashed lined
and piece together with the second sheet

DRIED FLOWER EMBROIDERY

BY OLGA PRINKU

TYPOGRAPHY

Print at 100%, cut along the dashed lined
and piece together with the second sheet

DRIED FLOWER EMBROIDERY

BY OLGA PRINKU

TYPOGRAPHY

Print at 100%, cut along the dashed lined
and piece together with the second sheet

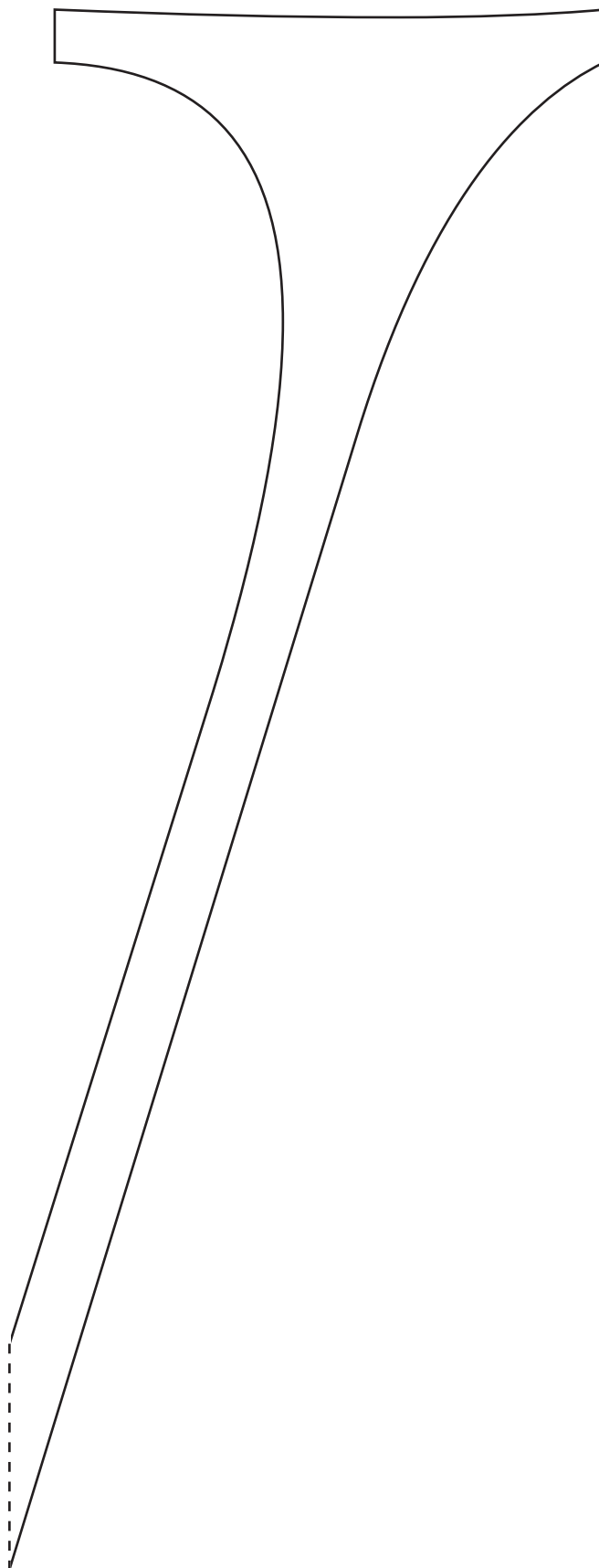



DRIED FLOWER EMBROIDERY

BY OLGA PRINKU

TYPOGRAPHY

Print at 100%, cut along the dashed lined
and piece together with the second sheet

DRIED FLOWER EMBROIDERY

BY OLGA PRINKU

TYPOGRAPHY

Print at 100%, cut along the dashed lined
and piece together with the second sheet

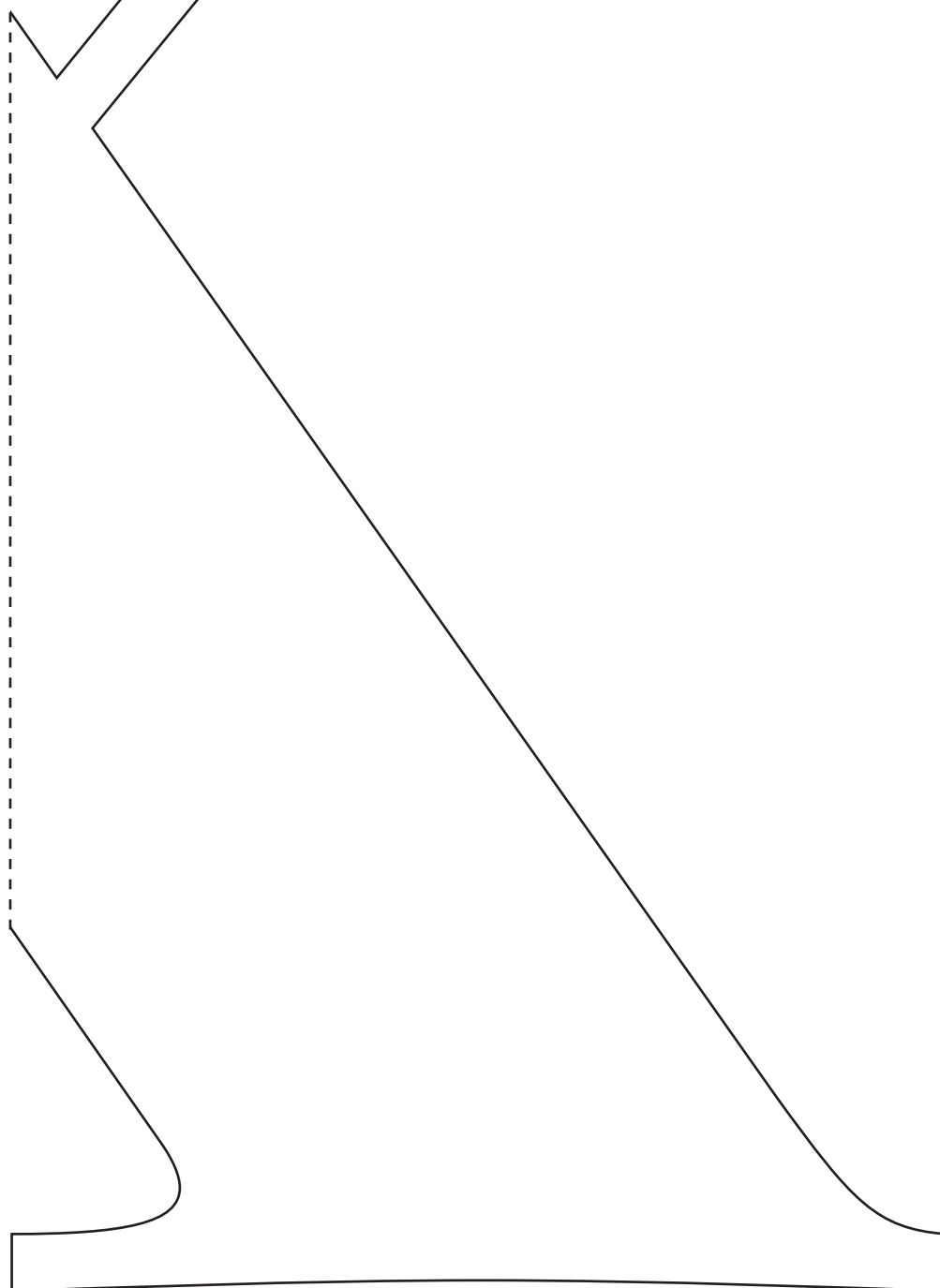

DRIED FLOWER EMBROIDERY

BY OLGA PRINKU

TYPOGRAPHY

Print at 100%, cut along the dashed lined
and piece together with the second sheet

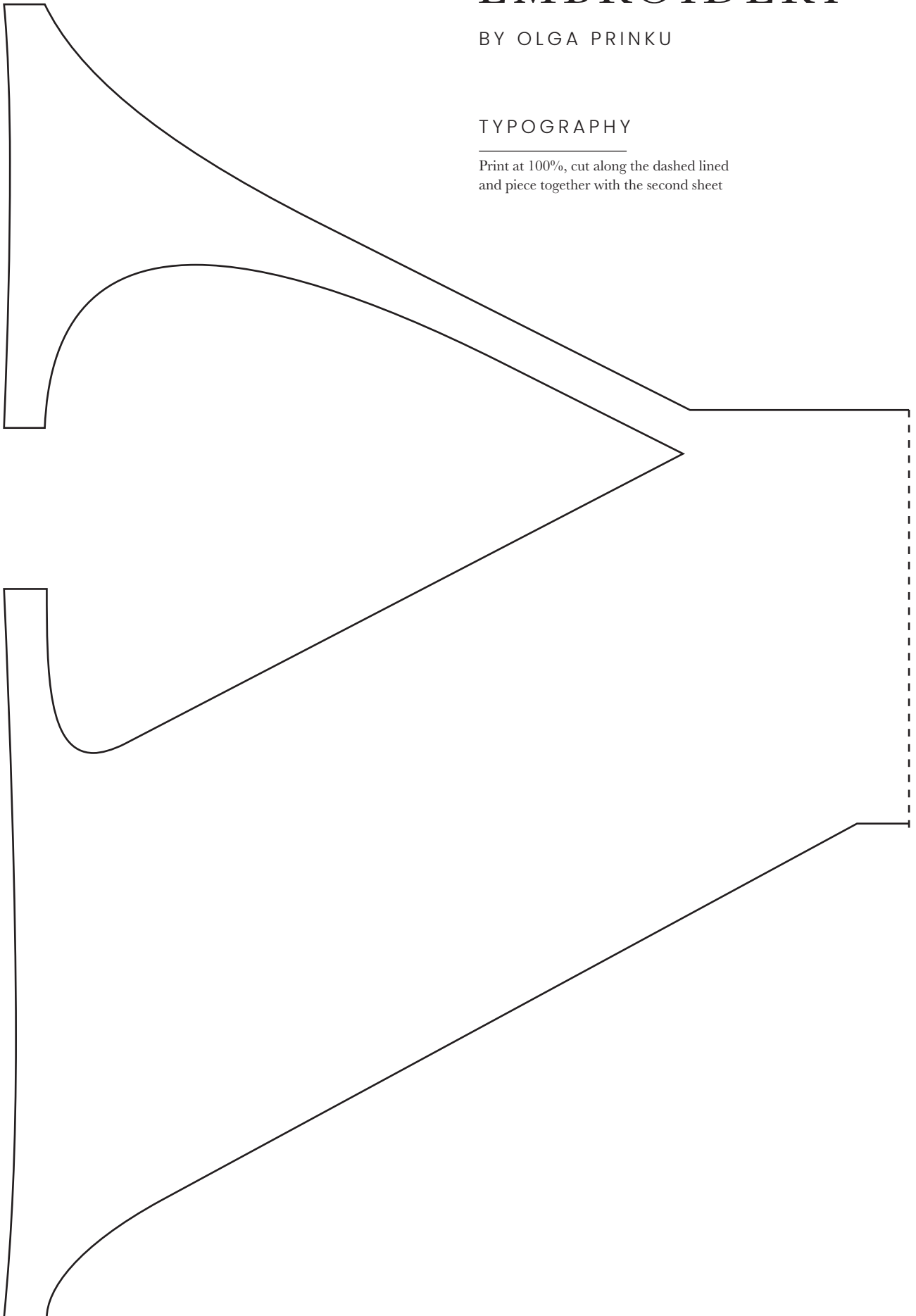

DRIED FLOWER EMBROIDERY

BY OLGA PRINKU

TYPOGRAPHY

Print at 100%, cut along the dashed lined
and piece together with the second sheet

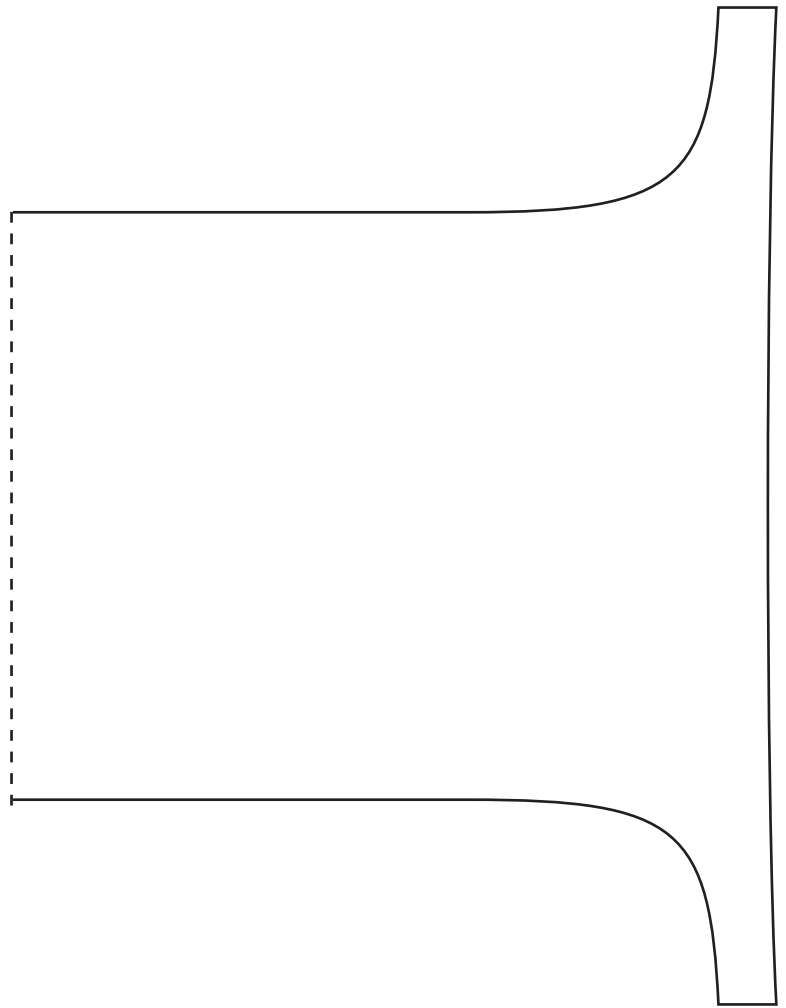

DRIED FLOWER EMBROIDERY

BY OLGA PRINKU

TYPOGRAPHY

Print at 100%, cut along the dashed lined
and piece together with the second sheet

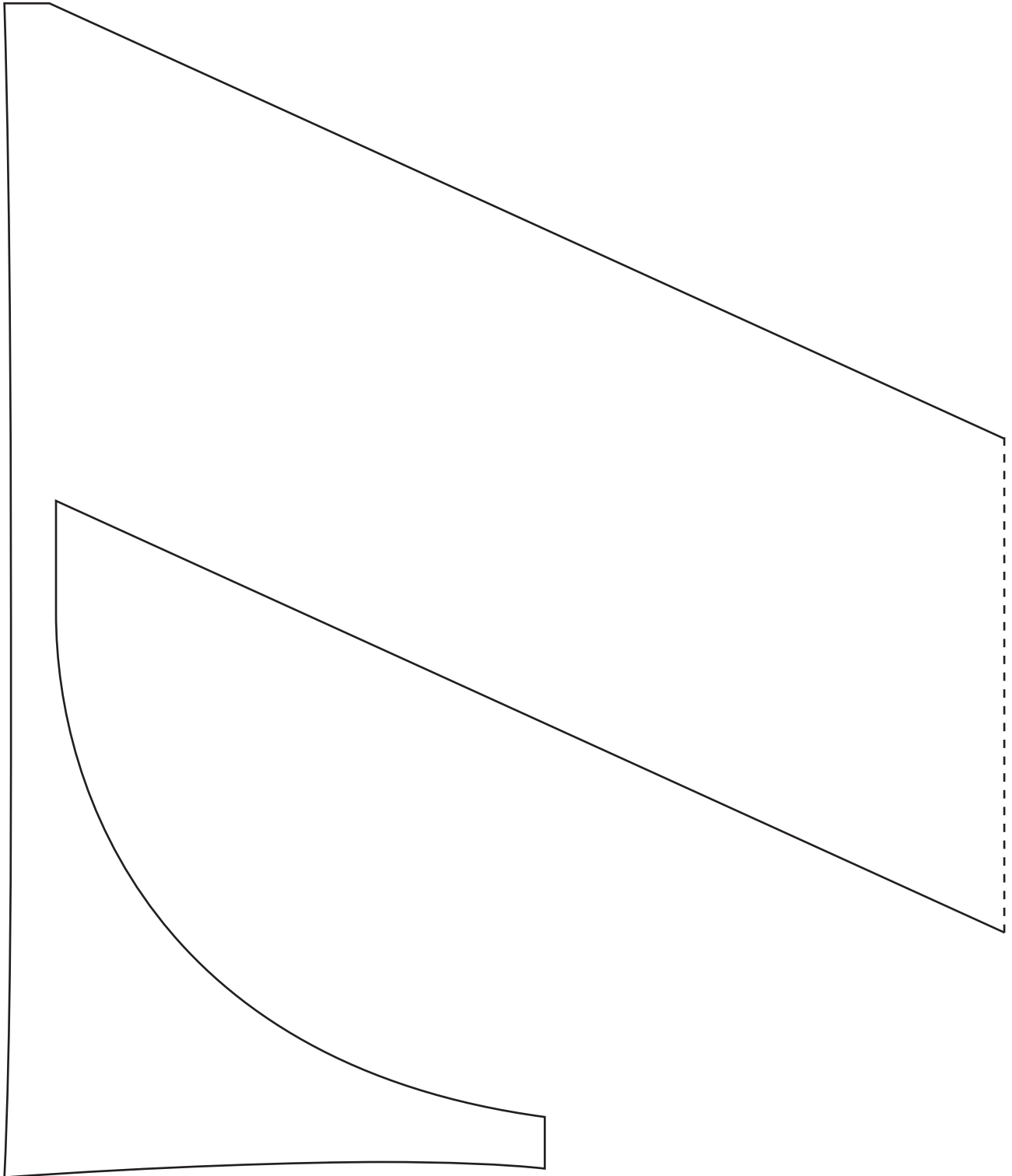

DRIED FLOWER EMBROIDERY

BY OLGA PRINKU

TYPOGRAPHY

Print at 100%, cut along the dashed lined
and piece together with the second sheet

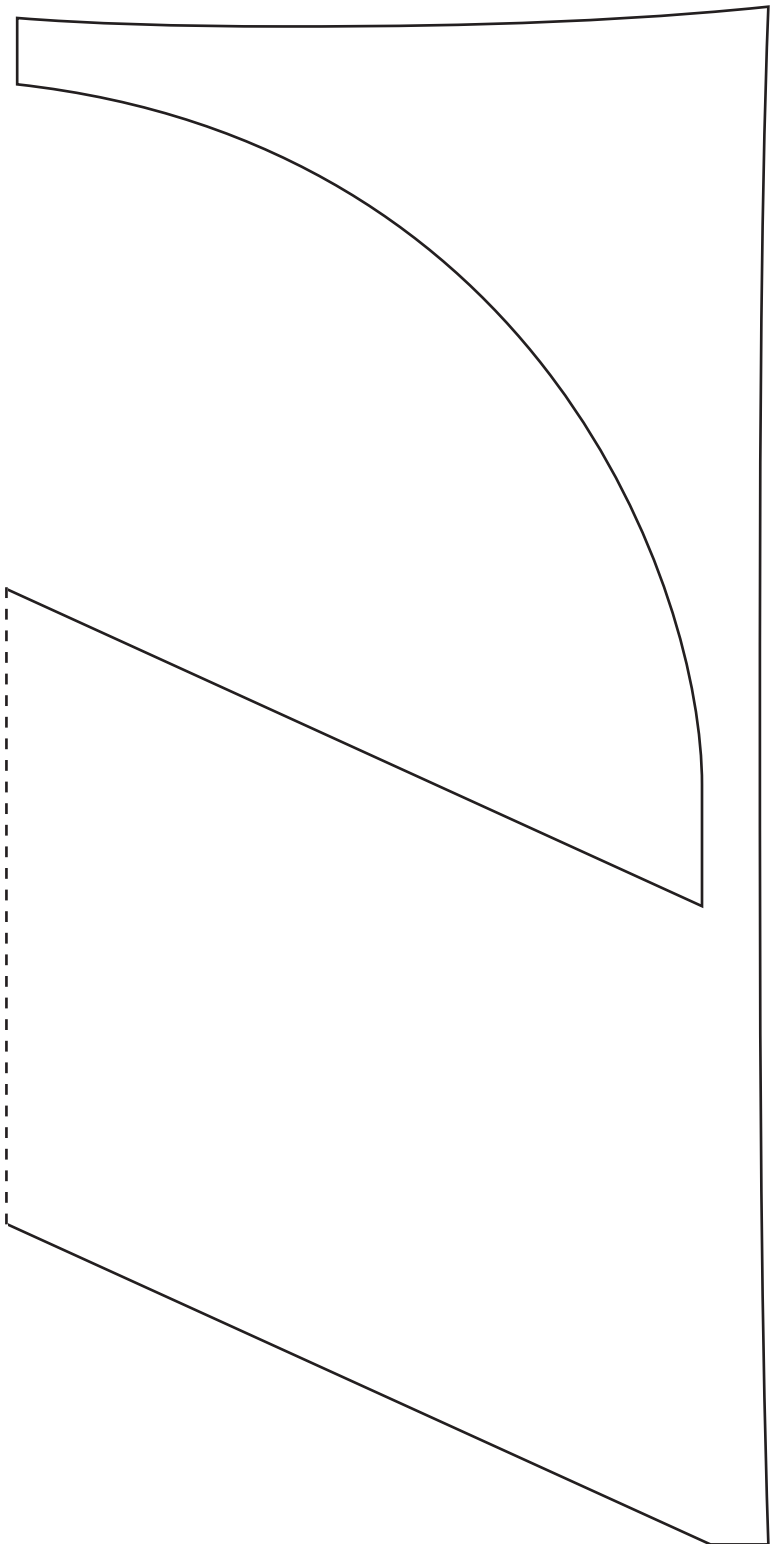

DRIED FLOWER EMBROIDERY

BY OLGA PRINKU

BIRD (1)

Print at 100%, cut along the dashed lined
and piece together with sheet 2

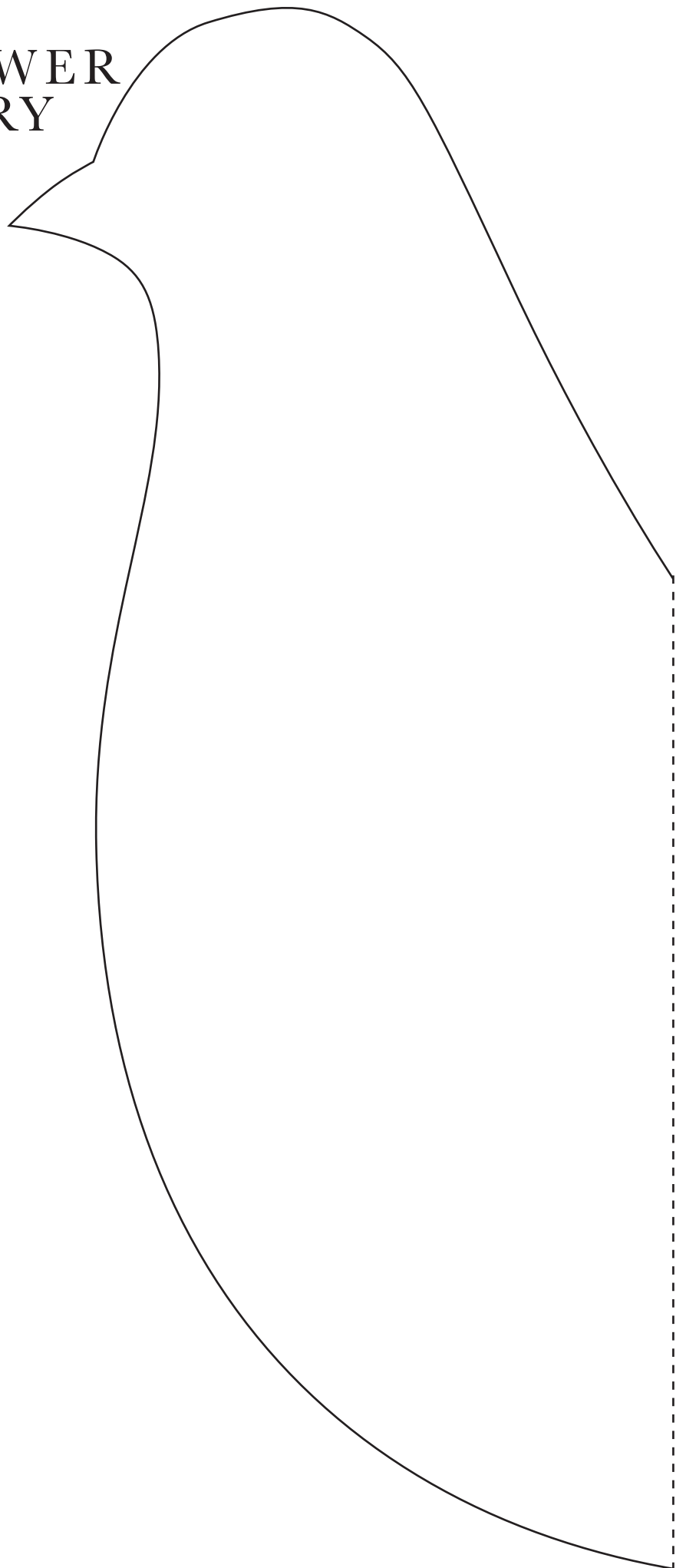

DRIED FLOWER EMBROIDERY

BY OLGA PRINKU

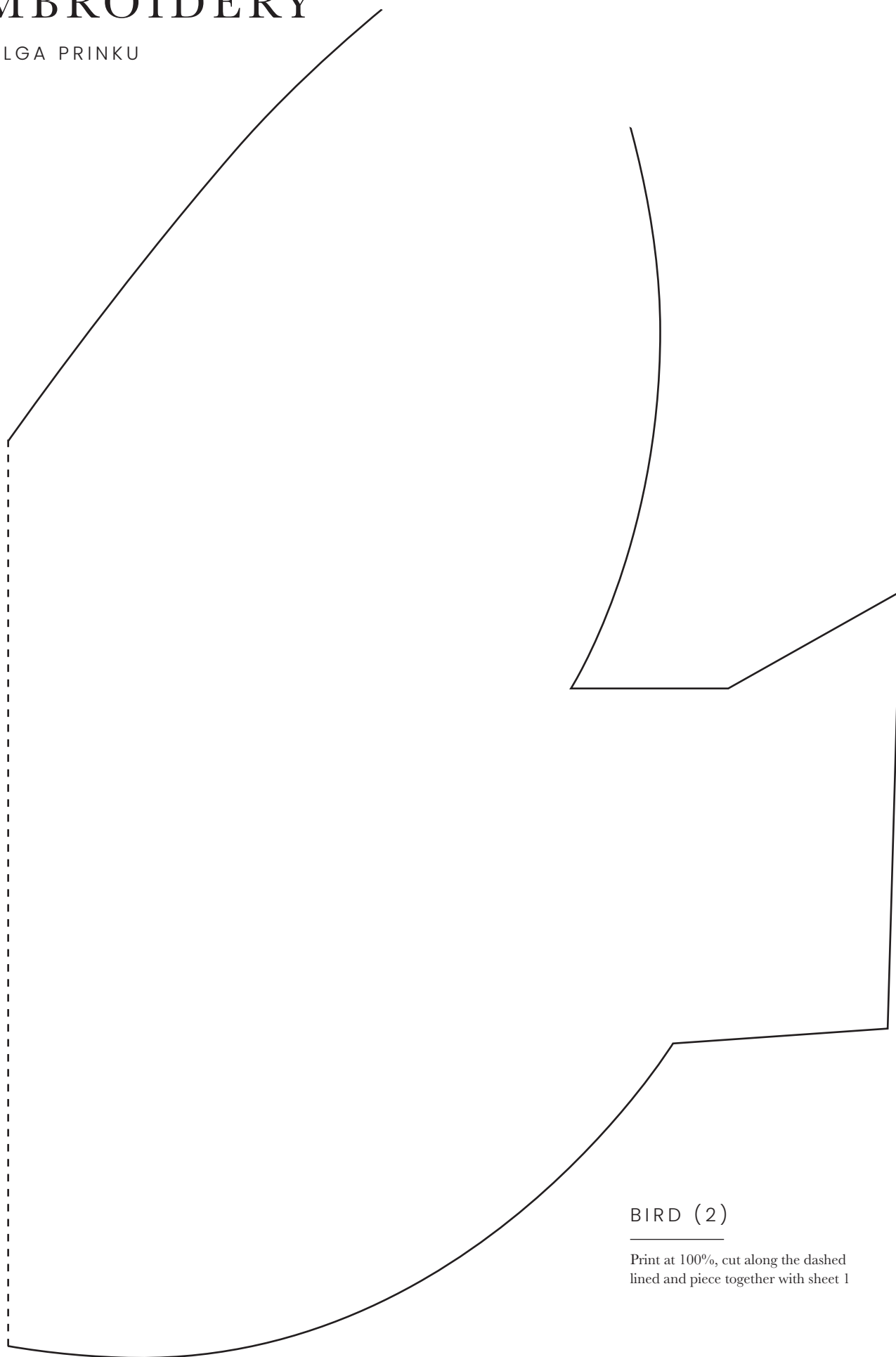

BIRD (2)

Print at 100%, cut along the dashed lined and piece together with sheet 1

DRIED FLOWER EMBROIDERY

BY OLGA PRINKU

SKULL

Print at 100%

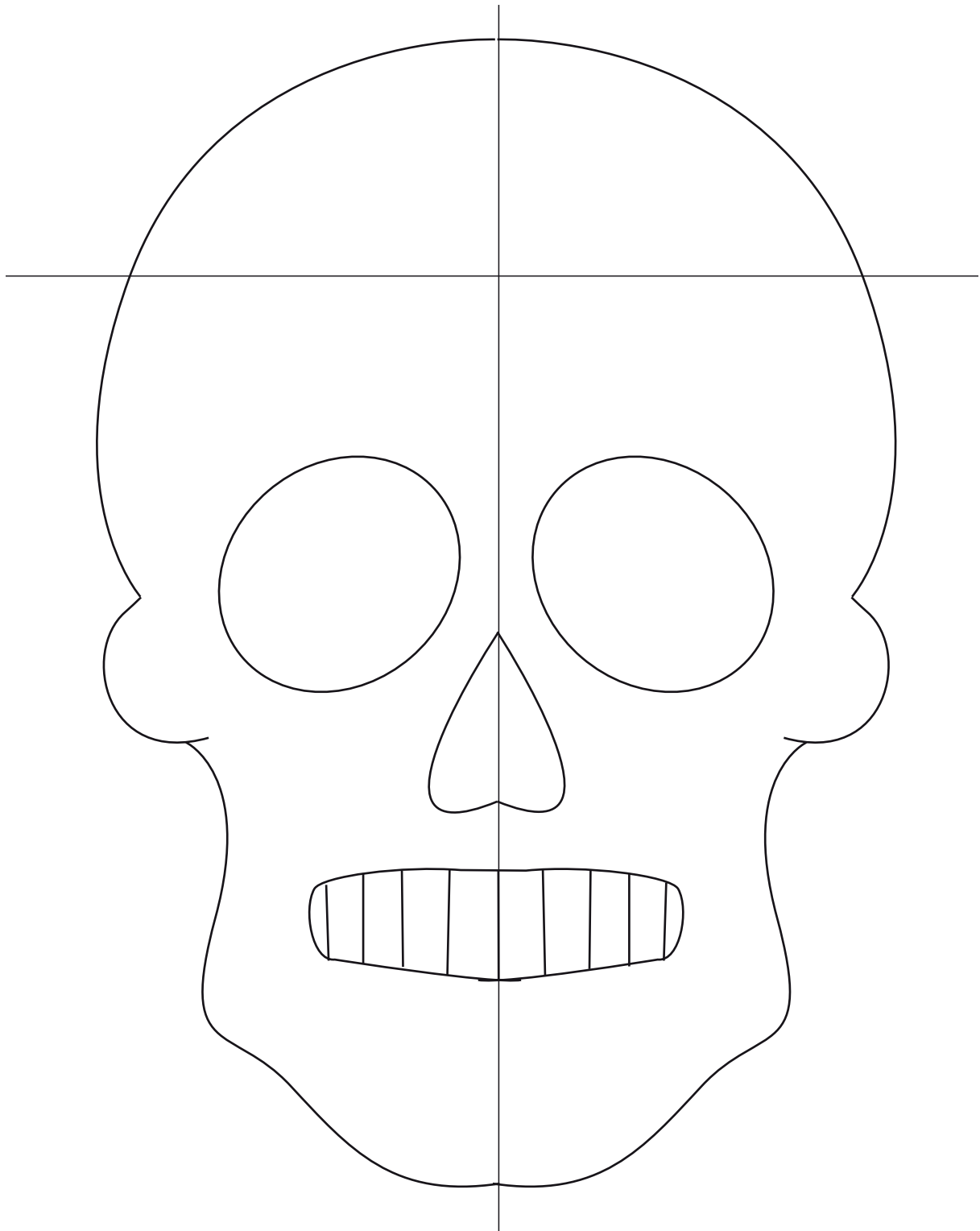

DRIED FLOWER EMBROIDERY

BY OLGA PRINKU

PETER PAN COLLAR

Print two at 100%

